



An Oshkosh Corporation Company

Illustrated Parts Manual

Compact Crawler

X14J/2

X14J/3

X390AJ/2

X390AJ/3

ANSI



3121601

September 07, 2015

 SOTTOCARRO CINGOLATO

 TRACKED UNDERCARRIAGE

 CHENILLARD

RAUPENFAHRWERK 



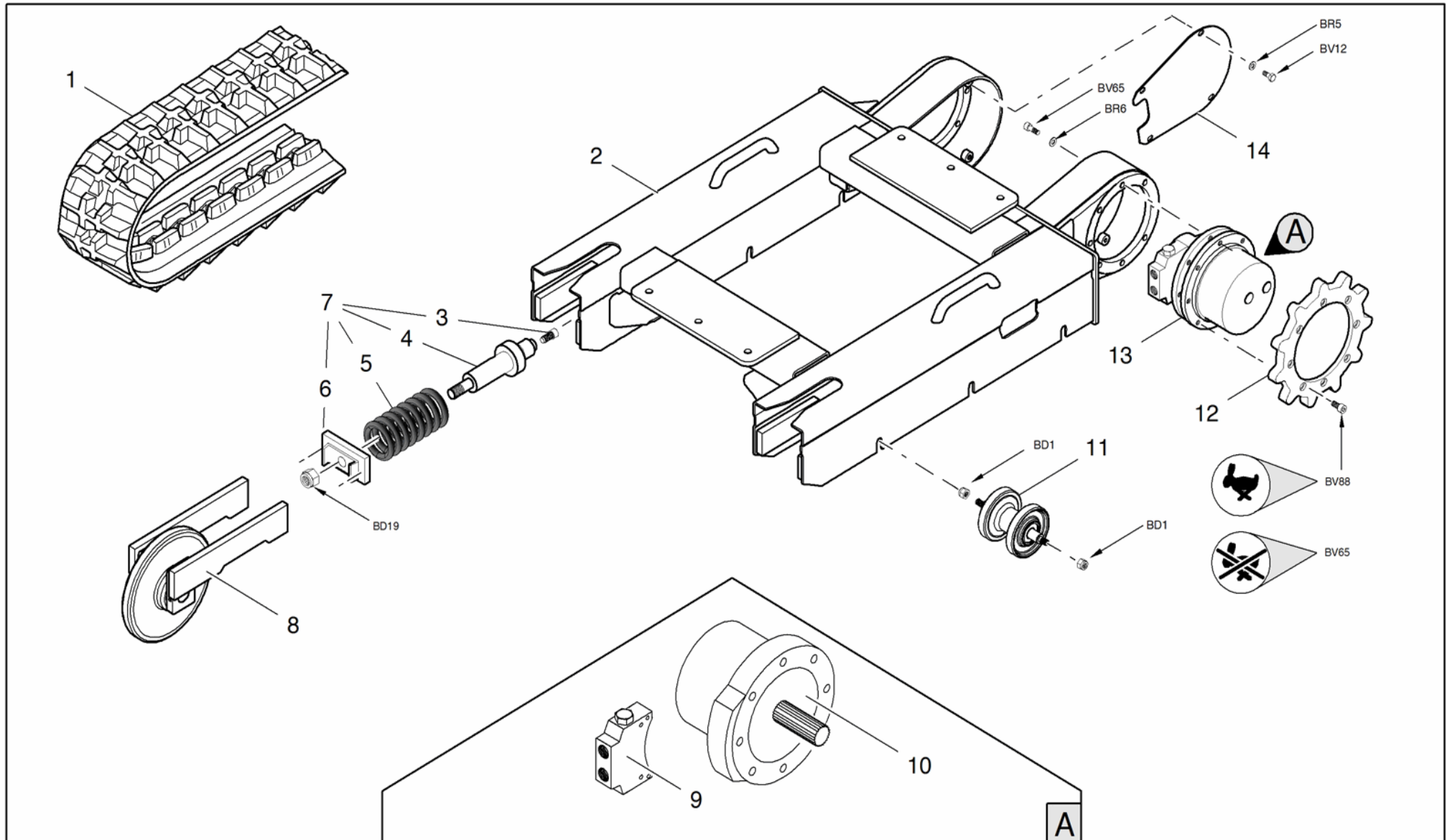

CARRO DE ORUGAS 



 SOTTOCARRO CINGOLATO

 RAUPENFAHRWERK 
 TRACKED UNDERCARRIAGE





 CARRO DE ORUGAS 
 CHENILLARD

POS	Codice	Q.tà	 Descrizione	 Description	 Designation	 Benennung	 Descripcìon
1	05371500	2 NR	cingolo in gomma alto profilo nero	rubber track standard high profile black	chenille en caoutchouc	gummiraupe	oruga de goma
1	053715L0	2 NR	cingolo in gomma basso profilo nero	rubber track low profile black	chenille en caoutchouc	gummiraupe	oruga de goma
1	053715LB	2 NR	cingolo in gomma basso profilo antitraccia	rubber track low profile no marking	chenille en caoutchouc	gummiraupe	oruga de goma
2	35609600	1 NR	carro cingolato	tracked undercarriage	chenillard	raupenfahrwerk	carro de orugas
2	35955300	1 NR	struttura	structure	structure	struktur	estructura
3	03149200	1 NR	valvola idraulica	hydraulic valve	valve hydraulique	valve hydraulique	válvula hidráulica
4	10681670	1 NR	cilindro	cylinder	vérin	zylinder	cilindro
5	03024800	1 NR	molla	spring	ressort	feder	muelle
6	34719500	1 NR	piatto	plate	plateau	platte	placa
7	14753400	2 NR	supporto tendicingolo	idler support	support tendeur chenille	kettehspanner-halter	soporte tensor oruga
8	15393700	2 NR	ruota tendicingolo	idler wheel	roue tendeur de chenille	raupenspannrاد	rueda tensor oruga
9	1450590003	1 NR	valvola idraulica	hydraulic valve	valve hydraulique	valve hydraulique	válvula hidráulica
10	1450590002	1 NR	motore idraulico	hydraulic motor	moteur hydraulique	hydraulikmotor	motor hidráulico

 SOTTOCARRO CINGOLATO

 RAUPENFAHRWERK 
 TRACKED UNDERCARRIAGE

 CARRO DE ORUGAS 
 CHENILLARD

POS Codice	Q.tà	 Descrizione	 Description	 Designation	 Benennung	 Descripción
11 15351500	6 NR	rullo inferiore	carrier roller	rouleau inférieur	untere roller	rodillo inferior
12 04173600	2 NR	ruota di trazione	sprocket wheel	roue de traction	antriebsrad	rueda de arrastre
12 07028900	2 NR	ruota di trazione 2 velocità	sprocket wheel high speed	roue de traction	antriebsrad	rueda de arrastre
13 14505900	2 NR	motoriduttore	gear motor	motoréducteur	getriebemotor	motorreductor
13 27028800	2 NR	motore idraulico 2 velocità	hydraulic motor high speed	moteur hydraulique	hydraulikmotor	motor hidráulico
14 05380900	2 NR	coperchio	cover	couvercle	deckel	tapa
14 05486800	2 NR	coperchio 2 velocità	cover high speed	couvercle	tapa	deksel

 BASE TORRETTA

ARBEITSTURM 



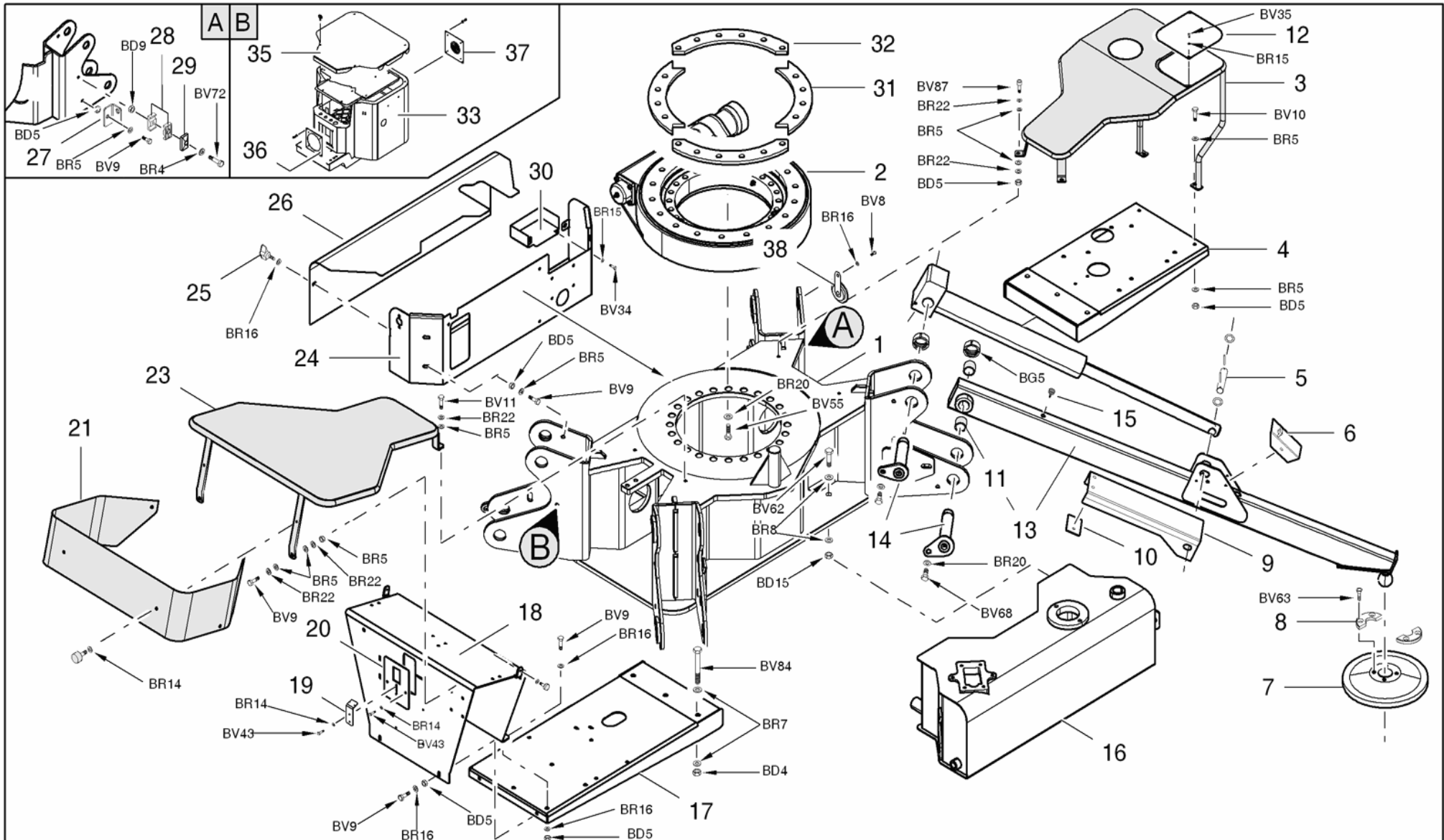

 TURRET BASE

BASE TORRETA GIRATORIA 

 BASE TOURELLE



 BASE TORRETTA
ARBEITSTURM 
 TURRET BASE
BASE TORRETTA GIRATORIA 
 BASE TOURELLE

POS Codice	Q.tà	 Descrizione	 Description	 Designation	 Benennung	 Descripción
1 35812000	1 NR	base piattaforma	platform base	base plateforme	arbeitsbühnenuntergestell	base plataforma
2 26119100	1 NR	ralla	fifth wheel	couronne dentée	drehkranz	tejuelo
3 161635J0	1 NR	protezione motore benzina	protection petrol engine	moteur à essence de protection	schutz benzinmotor	motor de gasolina de protección
3 358016J0	1 NR	protezione motore diesel	diesel engine protection	diesel protection du moteur	diesel engine schutz	protección del motor diesel
4 358504J0	1 NR	supporto	support	support	halterung	soporte
5 06230700	4 NR	spina	pin	cheville	stif	clavija
6 35618300	4 NR	carter	sump	carter	kurbelgehäuse	cárter
7 05446300	4 NR	disco	disk	disque	scheibe	disco
8 05446400	8 NR	semiflangia	half flange	demi-bride	halb flansch	semi brida
9 05472500	4 NR	protezione	protection	protection	schutz	protección
10 07495600	0,28 NR	gomma adesiva di protezione	rubber adhesive protection	gomme adhesive de protection	schutz-klebegummi	goma adhesiva de protección
11 06272500	2 NR	boccola	bush	douille	buchse	casquillo
12 061633J0	1 NR	coperchio	cover	couvercle	deckel	tapa
13 162826J0	4 NR	stabilizzatore completo	complete stabilizer	stabilisateur complet	stabilizer komplett	estabilizador completo

 BASE TORRETTA
ARBEITSTURM 
 TURRET BASE
BASE TORRETTA GIRATORIA 
 BASE TOURELLE

POS Codice	Q.tà	 Descrizione	 Description	 Designation	 Benennung	 Descripcìon
14 06229200	4 NR	spina	pin	cheville	stif	clavija
15 06061800	4 NR	antivibrante	anti-vibrating	anti - vibrant	vibrationsdämpfer	antivibrante
16 154442J0	1 NR	serbatoio olio completo	complete oil tank	réservoir d'huile complet	öltank komplett	depósito de aceite completo
17 358097J0	1 NR	supporto	support	support	halterung	soporte
18 058098J0	1 NR	protezione	protection	protection	schutz	protección
19 06118600	1 NR	lamiera piegata	folded plate	tôle pliée	blech gebogen	chapa doblada
20 061187Y1	1 NR	piastra	plate	platine	platte	placa
21 058510J0	1 NR	carter	sump	carter	kurbelgehäuse	cárter
23 358104J0	1 NR	protezione	protection	protection	schutz	protección
24 058964J0	1 NR	supporto	support	support	halterung	soporte
25 05611000	5 NR	galletto	wing nut	ecrou papillon	flügelmutter	tuerca de mariposa
26 061890J0	1 NR	coperchio	cover	couvercle	deckel	tapa
27 05562900	1 NR	staffa	bracket	étrier	haltebügel	estribo
29 05625800	4 NR	piastrina	plate	plaquette	plättchen	placa
30 06189100	1 NR	protezione	protection	protection	schutz	protección
31 06473900	2 NR	spessore femmina	spacer female	cale	stärke	espesor





 BASE TORRETTA

ARBEITSTURM 

 TURRET BASE

BASE TORRETA GIRATORIA 

 BASE TOURELLE

POS Codice	Q.tà	 Descrizione	 Description	 Designation	 Benennung	 Descripcìon
32 06474000	2 NR	spessore maschio	spacer male	cale	stärke	espesor
33 36851000	1 NR	cassone	dumper bed	caisson	dumpermulde	cajon
35 06853100	1 NR	coperchio	cover	couvercle	deckel	tapa
36 06779900	1 NR	tappo ventola anteriore	cap front fan	bouchon	verschluss	tapón
37 06780800	1 NR	tappo ventola posteriore	cap rear fan	bouchon	verschluss	tapón
38 04834500	1 NR	avvisatore acustico	acoustic alarm	avertisseur sonore	hupe	avisador acústico

 SERBATOIO OLIO

ÖLTANK 

 OIL TANK

DEPÓSITO DE ACEITE 



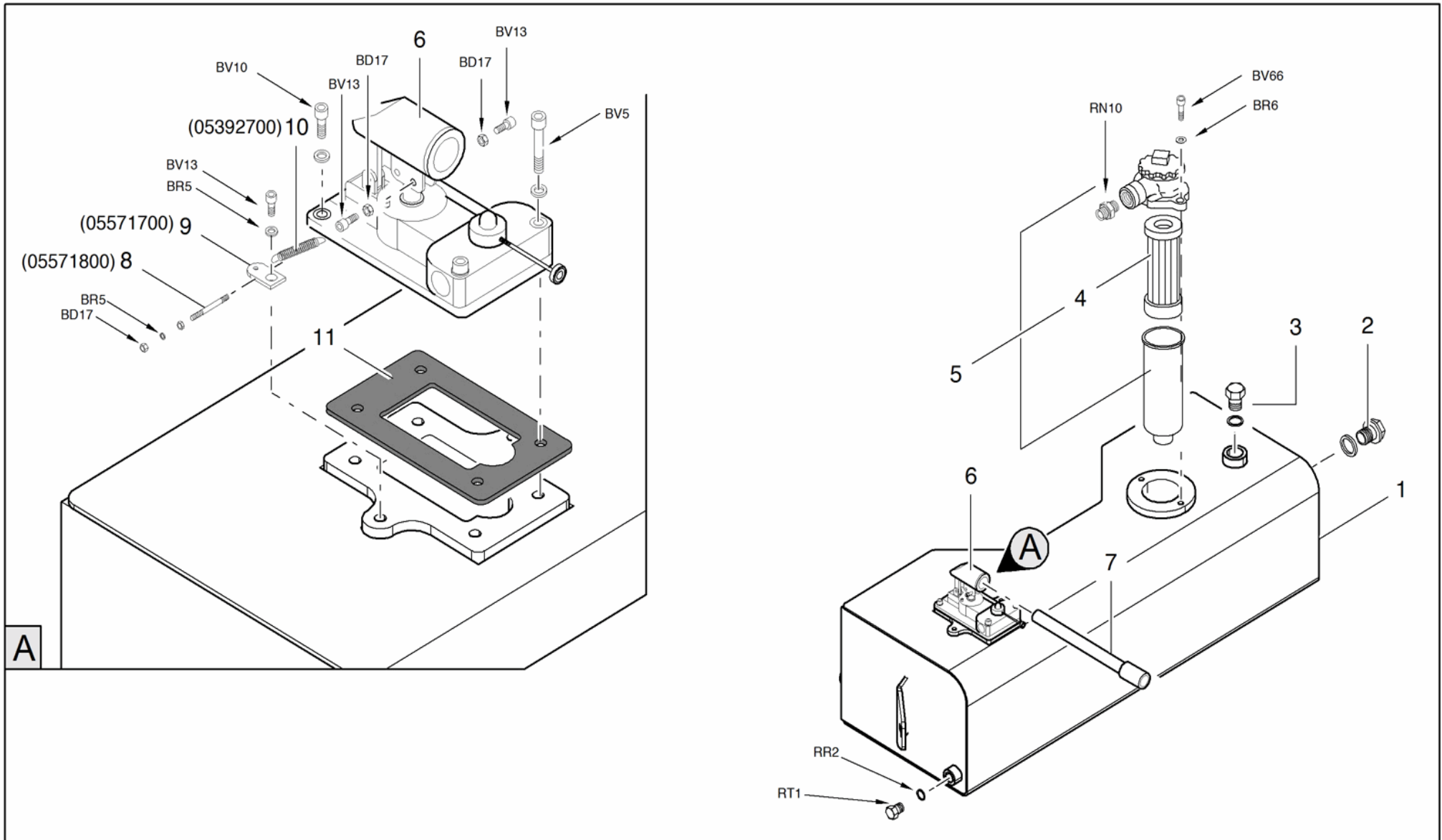

 RÉSERVOIR D'HUILE







 SERBATOIO OLIO

 ÖLTANK 
 OIL TANK





 DEPÓSITO DE ACEITE 
 RÉSERVOIR D'HUILE

POS Codice	Q.tà	 Descrizione	 Description	 Designation	 Benennung	 Descripcìon
1 35444200	1 NR	serbatoio olio	oil tank	réservoir d'huile	öltank	depósito de aceite
1 354442J0	1 NR	serbatoio olio	oil tank	réservoir d'huile	öltank	depósito de aceite
2 05061800	1 NR	livello olio	oil level	niveau huile	ölstand	nivel aceite
3 05611800	1 NR	tappo olio	oil plug	bouchon d'huile	öldeckel	tapón aceite
4 05120200	1 NR	cartuccia filtro olio idraulico	oil filter insert	filtre à huile	ölfilter	filtro aceite
5 15120100	1 NR	filtro olio idraulico completo	complete hydraulic oil filter	filtre à huile	ölfilter	filtro aceite
6 27316300	1 NR	pompa a mano	hand pump	pompe manuelle	handpumpe	bomba de mano
7 05521300	1 NR	leva	lever	levier	hebel	palanca
11 2550890001	1 NR	guarnizione di base per pompa a mano	basic gasket for hand pump	joint		





 PRIMO BRACCIO
ERSTER AUSLEGERARM 
 FIRST ARM
PRIMO BRAZO 
 PREMIER BRAS

POS Codice	Q.tà	 Descrizione	 Description	 Designation	 Benennung	 Descripción
1 06283300	4 NR	spina	pin	cheville	stif	clavija
2 06282500	4 NR	boccola	bush	douille	buchse	casquillo
3 162821J0	2 NR	tirante	tie rod	tirant	turmgestänge	tirante
4 05849000	2 NR	pattino	slide block	patin	gleitblock	patín
5 359196J0	1 NR	rinvio	transmission	renvoi	vorgelege	reenvio
6 06282900	1 NR	spina	pin	cheville	stif	clavija
7 06272400	4 NR	boccola	bush	douille	buchse	casquillo
8 162820J0	1 NR	primo braccio completo	complete first arm	premier bras complet	erster auslegerarm komplett	primo brazo completo
9 06282800	1 NR	spina	pin	cheville	stif	clavija
10 06283000	2 NR	spina	pin	cheville	stif	clavija
11 04538200	1 NR	pistoncino	piston	petit piston	kleiner kolben	pistón
12 359191J0	1 NR	supporto bracci	arms support	support bras	armehalterung	soporte brazos
13 05884000	1 NR	supporto	support	support	halterung	soporte
14 05884800	1 NR	perno	pin	goujon	zapfen	pernio
15 158842J0	1 NR	fermo	retainer	arrêt	halterung	bloque
16 05883600	2 NR	rotellina	small roller	roulette	rädchen	ruedecilla

 PRIMO BRACCIO
ERSTER AUSLEGERARM 
 FIRST ARM
PRIMO BRAZO 
 PREMIER BRAS

POS Codice	Q.tà	 Descrizione	 Description	 Designation	 Benennung	 Descripcìon
17 05427200	1 NR	livella	level	niveau	wasserwaage	nivel de burbuja
18 05444800	3 NR	molla	spring	ressort	feder	muelle
19 058832H3	1 NR	supporto	support	support	halterung	soporte
20 05855400	1 NR	spessore	thickness	cale	stärke	espesor
21 35812300	1 NR	fermo	retainer	arrêt	halterung	bloque
22 05796700	1 NR	indice allineamento	alignment indicator	indicateur d'alignement	ausrichtungsanzeig e	indicador alineación
23 05853700	1 NR	indice allineamento	alignment indicator	indicateur d'alignement	ausrichtungsanzeig e	indicador alineación
24 07192500	1 NR	carter protezione comandi a terra 14	guard control ground 14	carter	kurbelgehäuse	cárter
25 05903300	11 NR	pomello	knob	poignée	kugelgriff	pomo
26 05643600	1 NR	cassetta portamanuale	manual box	boîte porte-manuel	bedienungsanleitun gsfach	caja portamanual
27 05954300	1 NR	supporto	support	support	halterung	soporte
28 06286800	1 NR	flangia	flange	bride	flansch	brida
29 163150J0	1 NR	zavorra	counterweight	contrepoids	gegengewicht	contrapeso
30 36920600	1 NR	fermo	retainer	arrêt	halterung	bloque

 PRIMO BRACCIO
ERSTER AUSLEGERARM 
 FIRST ARM
PRIMO BRAZO 
 PREMIER BRAS

POS Codice	Q.tà	 Descrizione	 Description	 Designation	 Benennung	 Descripcìon
31 07189800	1 NR	coperchio carter distributore bracci versione ce x14	crankcase cover distributor arm ce version x14	couvercle	deckel	tapa
32 07189900	1 NR	cerniera a oscillazione libera	hinge swing free	charnière	scharnier	cabla charnela
33 07190000	1 NR	camma per serratura disassamento 9.5	cam lock for offset 9.5	came	nocken	leva
34 07178800	1 NR	serratura	lock	serrure	schloss	cerradura
35 07298800	1 NR	chiave per serratura postazione comando a terra	key to the lock on the ground control position	clef	chlüssel	clave

 SECONDO BRACCIO

ZWEITER AUSLEGERARM 

 SECOND ARM

SEGUNDO BRAZO 



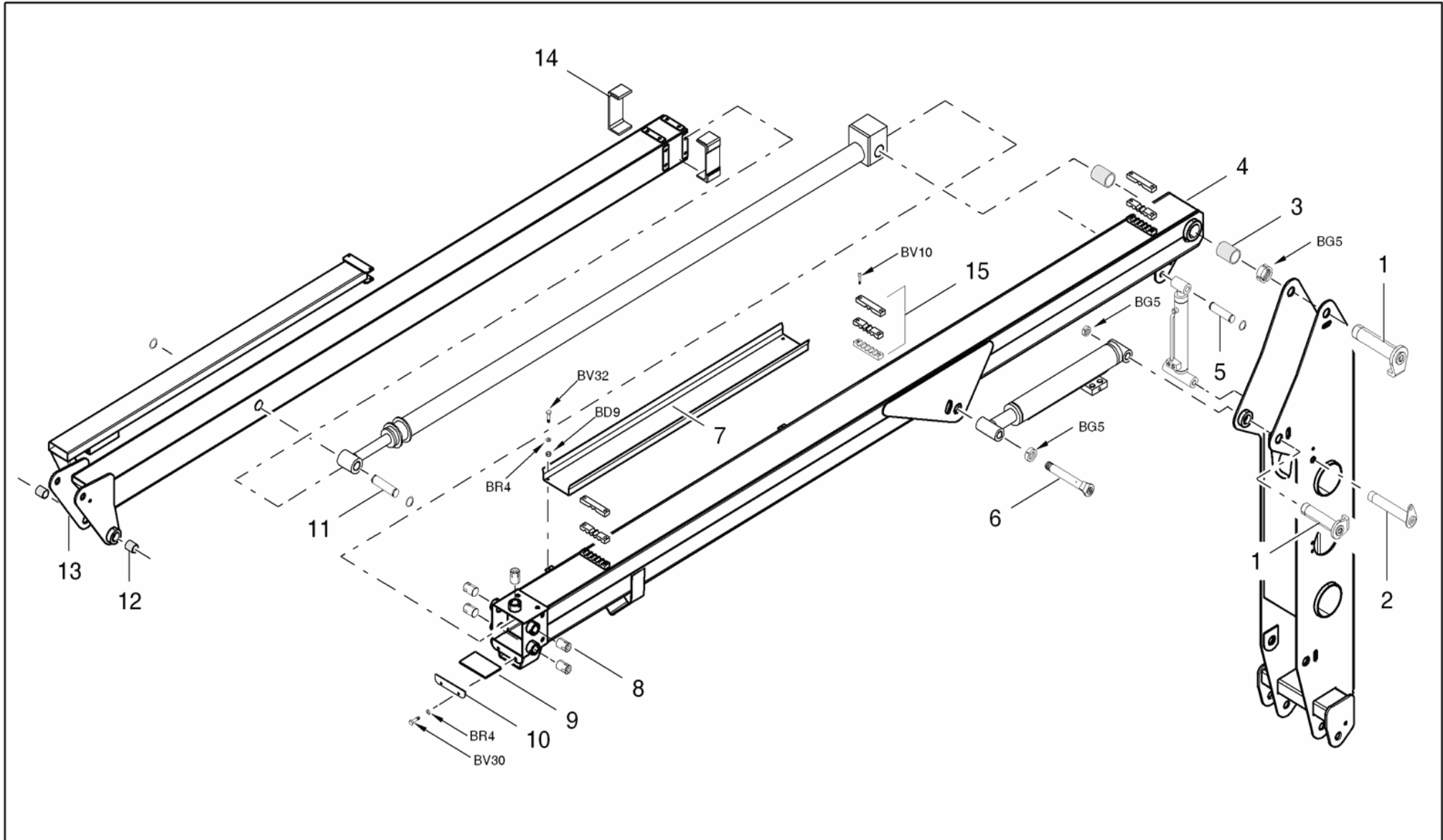

 SECOND BRAS



 SECONDO BRACCIO
ZWEITER AUSLEGERARM 
 SECOND ARM
SEGUNDO BRAZO 
 SECOND BRAS

POS Codice	Q.tà	 Descrizione	 Description	 Designation	 Benennung	 Descripción
1 06283100	2 NR	spina	pin	cheville	stif	clavija
2 06283400	1 NR	spina	pin	cheville	stif	clavija
3 06272200	2 NR	boccola	bush	douille	buchse	casquillo
4 162822J0	1 NR	secondo braccio completo	complete second arm	second bras complet	zweiter auslegerarm komplet	segundo brazo completo
5 06283500	1 NR	spina	pin	cheville	stif	clavija
6 06283200	1 NR	spina	pin	cheville	stif	clavija
7 05805000	1 NR	supporto	support	support	halterung	soporte
8 05804700	5 NR	pattino	slide block	patin	gleitblock	patín
9 05917800	1 NR	pattino	slide block	patin	gleitblock	patín
10 05804800	1 NR	piatto ferma pattino	plate lock slide block	chaussures plates arrets	flat shoe stoppt	zapato plano paradas
11 06236500	1 NR	spina	pin	cheville	stif	clavija
12 06272600	4 NR	boccola	bush	douille	buchse	casquillo
13 162823J0	1 NR	primo sfilo completo	cpmplet first extension arm	premier bras d'extraction complete	erster teleskoparm komplett	primo brazo de extensión completo
14 07068500	2 NR	pattino	slide block	patin	gleitblock	patín

 SECONDO BRACCIOZWEITER AUSLEGERARM  SECOND ARMSEGUNDO BRAZO  SECOND BRAS

POS Codice	Q.tà	 Descrizione	 Description	 Designation	 Benennung	 Descripcìon
15 07094200	1 NR	morsetto tubi	clamp	bride	bundring	collar





 CATENA PORTACAVI FLESSIBILE

SCHLAUCH SCHLEPPKETTE 

 FLEXIBLE CABLE-HOLDER CHAIN

CADENA PORTACABLES FLEXIBLE 





 CHAÎNE PORTE-CABLES FLEXIBLE

POS	Codice	Q.tà	 Descrizione	 Description	 Designation	 Benennung	 Descripcìon
1	25855800	1 NR	catena porta cavi	cable-holder chain	chaîne porte-câbles	kabelhalterkette	cadena portacables
2	2585580001	1 NR	attacco femmina	female coupling	raccord femelle	aufsteckanschluss	empalme hembra
3	2585580002	1 NR	attacco maschio	male coupling	raccord mâle	steckanschluss	empalme macho
4	2585580003	38 NR	maglia catena	chain link	maillot chaîne	kettenglied	eslabón cadena
5	2585580004	38 NR	coperchio	cover	couvercle	deckel	tapa
6	05970300	1 NR	carter	sump	carter	kurbelgehäuse	cárter
7	05970400	1 NR	protezione	protection	protection	schutz	protección

 SUPPORTO CESTO

 HALTERUNG ARBEITSKORB 
 BASKET SUPPORT





 SOPORTE CESTA 
 PANIER CUPPORT

POS Codice	Q.tà	 Descrizione	 Description	 Designation	 Benennung	 Descripcìon
1 06230200	1 NR	spina	pin	cheville	stif	clavija
2 06282700	2 NR	spina	pin	cheville	stif	clavija
3 06272600	2 NR	boccola	bush	douille	buchse	casquillo
4 162824J0	1 NR	braccio jib completo	complet jib arm	fléchette bras complete	arm - schwenkarm komplett	brazo jib completo
5 358025J0	1 NR	tirante	tie rod	tirant	turmgestänge	tirante
6 358026J0	1 NR	tirante	tie rod	tirant	turmgestänge	tirante
7 06230300	1 NR	spina	pin	cheville	stif	clavija
8 05598800	1 NR	staffa	bracket	étrier	haltebügel	estribo
9 06228800	1 NR	spina	pin	cheville	stif	clavija
11 06272700	2 NR	boccola	bush	douille	buchse	casquillo
12 162801J0	1 NR	snodo completo	complete articulation	articulation complète	gelenk komplett	articulación completo
13 06230600	1 NR	spina	pin	cheville	stif	clavija
14 06230500	1 NR	spina	pin	cheville	stif	clavija
15 05863700	2 NR	perno supporto cesto (fornito a ricambio assemblato al tubo 05863600)	pin holder basket (spare parts provided assembled with tube 05863600)	goujon	zapfen	pernio

 SUPPORTO CESTO

 HALTERUNG ARBEITSKORB 
 BASKET SUPPORT

 SOPORTE CESTA 
 PANIER CUPPORT

POS Codice	Q.tà	 Descrizione	 Description	 Designation	 Benennung	 Descripción
16 05863600	2 NR	tubo supporto cesto (fornito a ricambio assemblato al perno 05863700)	tube basket holder (spare parts provided assembled with the pin 05863700)	tuyau rigide	rohr	tubo rígido
17 26084300	4 NR	cuscinetto	bearing	coussinet	lager	cojinete
18 36057800	1 NR	slitta	slide	coulisseau	schlitten	corredera
19 06058300	2 NR	tappo	cap	bouchon	verschluss	tapón
20 35887000	1 NR	supporto cesto	basket support	panier support	halterung arbeitskorb	soporte cesta
21 056187H3	1 NR	coperchio	box	couvercle	deckel	tapa
21 05618700	1 NR	coperchio	box	couvercle	deckel	tapa
22 058600H3	1 NR	piastra	plate	platine	platte	placa
23 26602600	1 NR	cesto 2 persone	two-person basket	panier 2 personnes	2 mann-arbeitskorb	cesta 2 personas
24 07031800	2 NR	tubo	pipe	tuyau	rohr	tubo
25 06613300	1 NR	piastra	plate	platine	platte	placa
26 16602500	1 NR	protezione	protection	protection	schutz	protección
27 06477600	1 NR	magnete ø20 con foro m3	magneto ø20 with m3 hole	aimant	magnet	imán
28 07173400	1 NR	piastra	plate	platine	platte	placa





 SUPPORTO CESTO

HALTERUNG ARBEITSKORB 

 BASKET SUPPORT

SOPORTE CESTA 

 PANIER CUPPORT

POS Codice	Q.tà	 Descrizione	 Description	 Designation	 Benennung	 Descripción
29 07052900	1 NR	staffa	bracket	étrier	haltebügel	estribo
30 06665000	2 NR	fune	cable	câble	seil	cable
31 06598500	1 NR	fune	cable	câble	seil	cable
32 05475900	2 NR	antivibrante	anti-vibrating	anti - vibrant	vibrationsdämpfer	antivibrante
33 36585800	1 NR	scaletta	ladder	échelle repliable	leiter	escalera plegable
34 06585900	2 NR	rotellina	small roller	roulette	rädchen	ruedecilla
35 06418600	1 NR	protezione	protection	protection	schutz	protección

 ACCOPPIAMENTO MOTORE DIESEL- POMPA

PUMPEN / DIESELMOTOR KUPPLUNG 



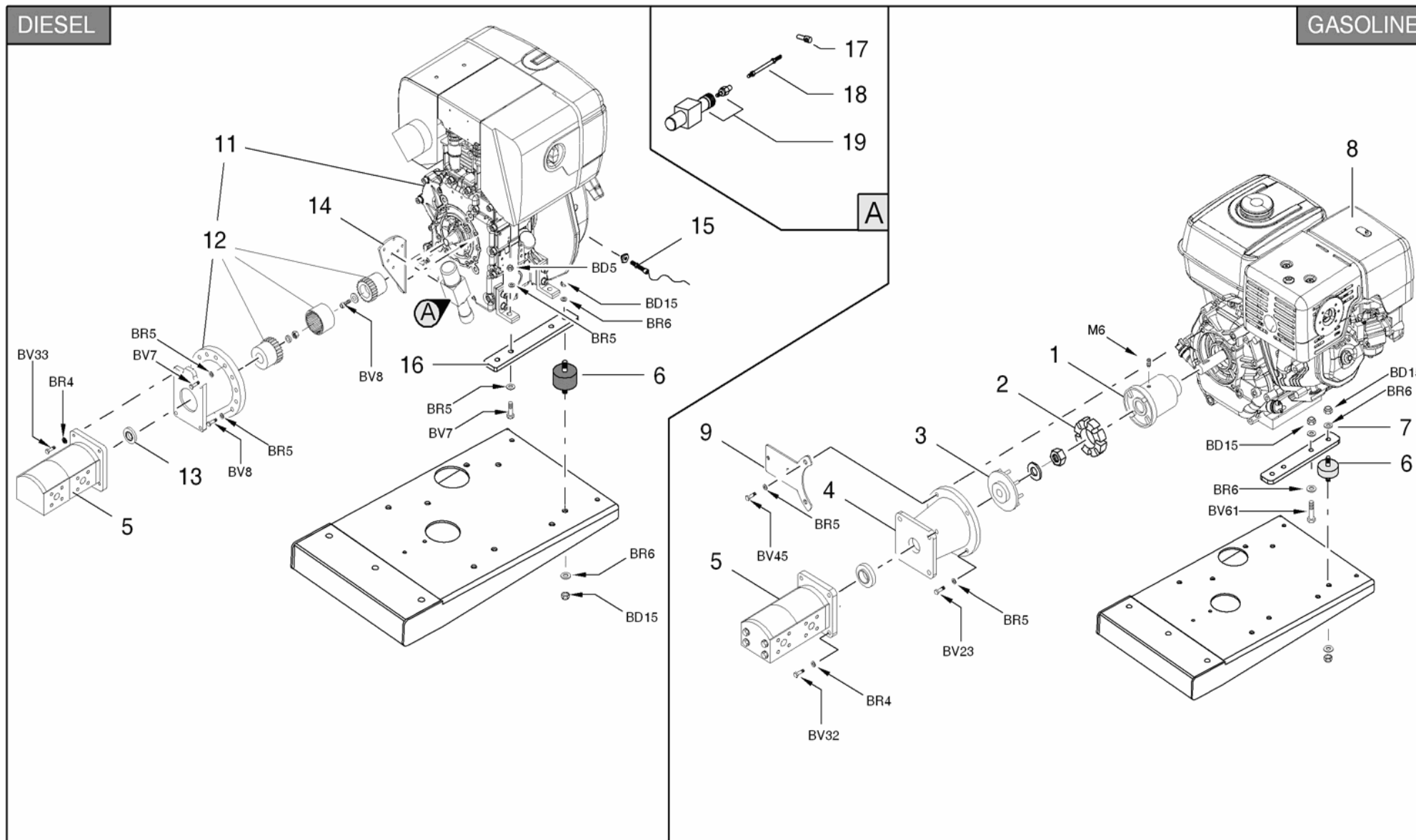

 DIESEL ENGINE COUPLING - PUMP

ACOPLAMIENTO MOTOR DIESEL- BOMBA 

 ACCOUPLEMENT MOTEUR DIESEL - POMPE



 ACCOPPIAMENTO MOTORE DIESEL- POMPA
PUMPEN / DIESELMOTOR KUPPLUNG 
 DIESEL ENGINE COUPLING - PUMP
ACOPLAMIENTO MOTOR DIESEL- BOMBA 
 ACCOUPLEMENT MOTEUR DIESEL - POMPE

POS Codice	Q.tà	 Descrizione	 Description	 Designation	 Benennung	 Descripción
1 04310200	1 NR	semigiunto	half coupling	demi-joint	halbverbindung	semi-acoplamiento
2 04310100	1 NR	inserto in gomma	rubber insert	insert en caoutchouc	gummieinsatz	inserto de goma
3 04615300	1 NR	giunto	coupling	joint	verbindung	acoplamiento
4 04310300	1 NR	lanterna	lantern	lanterne	buchse	linterna
5 25526300	1 NR	pompa idraulica	hydraulic pump	pompe hydraulique	hydraulikpumpe	bomba hidráulica
6 04152400	4 NR	antivibrante versione diesel	anti-vibrating diesel version	anti - vibrant	vibrationsdämpfer	antivibrante
6 05535300	4 NR	antivibrante versione benzina	anti-vibrating gasoline version	anti - vibrant	vibrationsdämpfer	antivibrante
7 04639300	2 NR	supporto	support	support	halterung	soporte
8 25535100	1 NR	motore benzina 9hp	petrol engine 9hp	moteur a essence 9hp	benzinmotor 9hp	motor de gasolina 9hp
8 25586400	1 NR	motore benzina 13hp	petrol engine 13hp	moteur a essence 13hp	benzinmotor 13hp	motor de gasolina 13hp
9 06093700	1 NR	staffa	bracket	étrier	haltebügel	estribo
11 27110500	1 NR	motore diesel hatz 7.5hp versione con predisposizione regolazioni giri elettronica (no carb-epa cert)	hatz diesel engine 7.5hp version with predisposition to electronic speed regulation (no carb-epa cert)	moteur diesel 7.5hp	dieselmotor 7.5hp	motor diesel 7.5hp





 ACCOPPIAMENTO MOTORE DIESEL- POMPA

PUMPEN / DIESELMOTOR KUPPLUNG 

 DIESEL ENGINE COUPLING - PUMP

ACOPLAMIENTO MOTOR DIESEL- BOMBA 

 ACCOUPLEMENT MOTEUR DIESEL - POMPE

POS Codice	Q.tà	 Descrizione	 Description	 Designation	 Benennung	 Descripcìon
12 2558630001	1 NR	accoppiamento motore - pompa	engine coupling - pump	accouplement moteur - pompe	pumpen-/motorkupplung	acoplamiento motor - bomba
14 07098900	1 NR	staffa	bracket	étrier	haltebügel	haltebügel
15 26514900	1 NR	sensore	sensor	capteur	sensor	sensor
16 05480700	2 NR	piastra	plate	platine	platte	placa
17 07098600	1 NR	perno	pin	goujon	zapfen	pernio
18 07098700	1 NR	tirante	tie rod	tirant	turmgestänge	tirante
19 26551500	1 NR	pistone	piston	piston	kolben	pistón
20 05559100	1 NR	distanziale	spacer	entretoise	distanzstück	distanciador

 RICAMBI MOTORE

MOTORERSATZTEILE 

 ENGINE SPARE PARTS

REPUESTOS MOTOR 



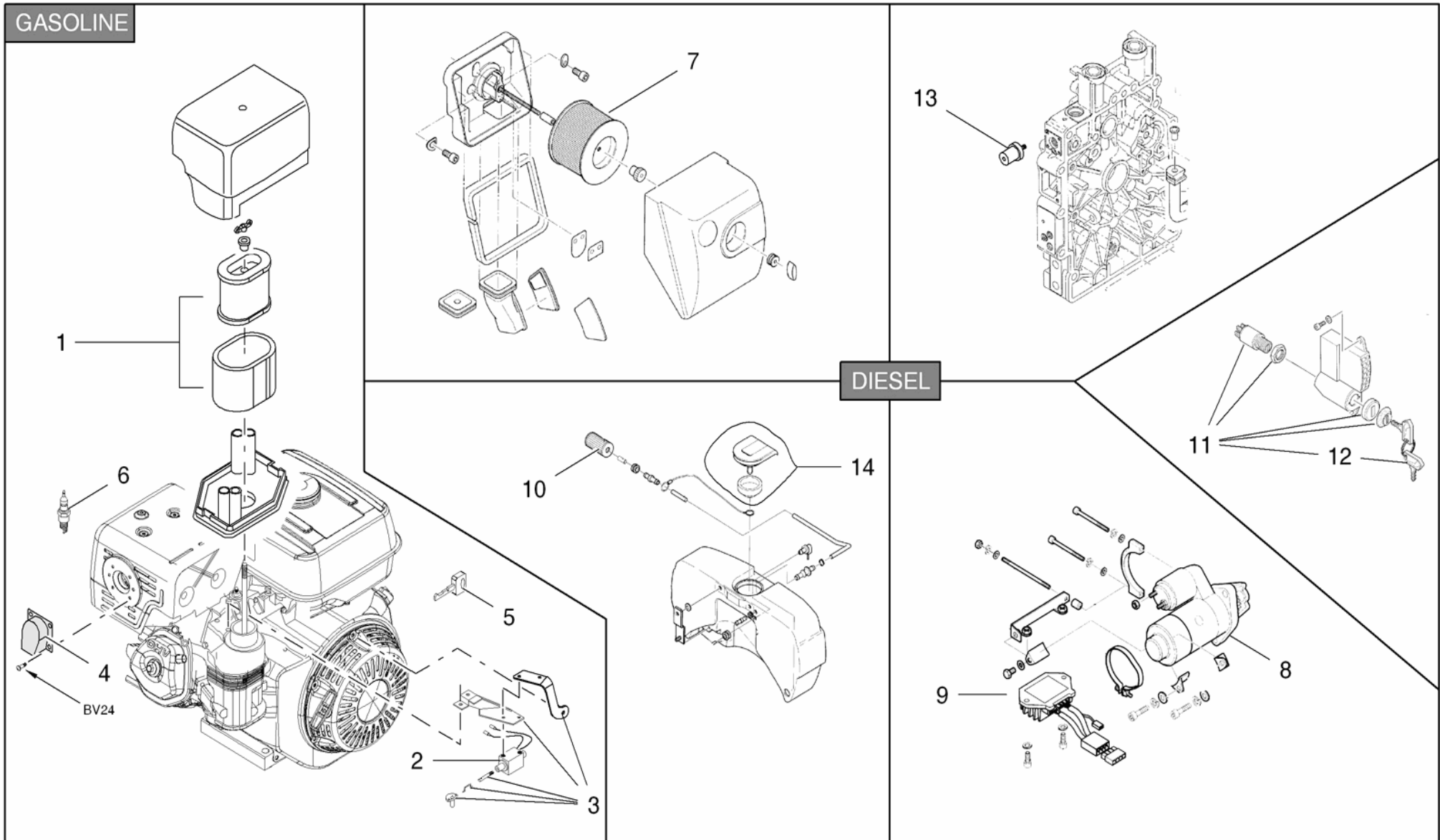

 PIÈCES DÉTACHÉES DU MOTEUR



 RICAMBI MOTORE

 MOTORERSATZTEILE 
 ENGINE SPARE PARTS





 REPUESTOS MOTOR 
 PIÈCES DÉTACHÉES DU MOTEUR

POS Codice	Q.tà	 Descrizione	 Description	 Designation	 Benennung	 Descripción
1 2558640001	1 NR	filtro aria per motore gx270	air filter for gx270 engine	filtre à air moteur gx270	luftfilter für gx270 motor	filtro de aire para motor gx270
1 2558640002	1 NR	cartuccia filtro aria gx390	air filter cartridge gx390	cartouche filtre à air gx390	luftfiltereinsatz gx390	cartucho filtro de aire gx390
2 05561200	1 NR	comando elettrico	electrical control	commande électrique	elektroanlage antrieb	comando eléctrica
3 25561300	1 NR	kit elettrico comando aria motore 9hp	electric kit choke engine 9hp	électrique kit starter moteur 9hp	elektrosatz drossel motor 9hp	kit eléctrico choke del motor 9hp
3 25621000	1 NR	kit elettrico comando aria motore 13hp	electric kit choke engine 13hp	électrique kit starter moteur 13hp	elektrosatz drossel motor 13hp	kit eléctrico choke del motor 13hp
4 06435300	1 NR	deflettore	deflector	défecteur	abweiser	deflector
5 2595260003	1 NR	chiave accensione motore	key ignition engine	clé moteur d'allumage	zündungsschalter engine	motor llave
6 2558640003	1 NR	candela accensione	sparking plug	bougie électrique	zündkerze	bujía encendido
7 2558630002	1 NR	cartuccia filtro aria	air filter cartridge	cartouche filtre à air	luftfiltereinsatz	cartucho filtro de aire
8 2558630004	1 NR	motorino avviamento	starter motor	démarrreur	anlasser	motor de arranque

 RICAMBI MOTORE

 MOTORERSATZTEILE 
 ENGINE SPARE PARTS

 REPUESTOS MOTOR 
 PIÈCES DÉTACHÉES DU MOTEUR

POS Codice	Q.tà	 Descrizione	 Description	 Designation	 Benennung	 Descripcìon
9 2558630005	1 NR	regolatore di tensione	voltage regulator	régulateur de tension	spannungsregler	regulador de tensión
9 2558630009	1 NR	regolatore di corrente hatz modello ducati	current regulator hatz ducati model	régulateur de tension moteur hatz	hydraulischer antrieb	comando hidráulico
10 2558630003	1 NR	filtro gasolio	gas oil filter	filtre à gasoil	kraftstofffilter	filtro gasóleo
11 2631430001	1 NR	blocchetto chiave	block	bloc	block	bloque
12 2631430002	1 NR	chiave accensione	ignition key	clef de démarrage	zündschlüssel	clave de encendido
13 2558630008	1 NR	solenoide	solenoid	solenoïde	solenoid	solenoide
14 2631430004	1 NR	tappo serbatoio gasolio	fuel tank cap	bouchon réservoir gasoil hatz 1b30-1b40	tankdeckel	tapa depósito gasoil

 MOTORE ELETTRICO

E-MOTOR 



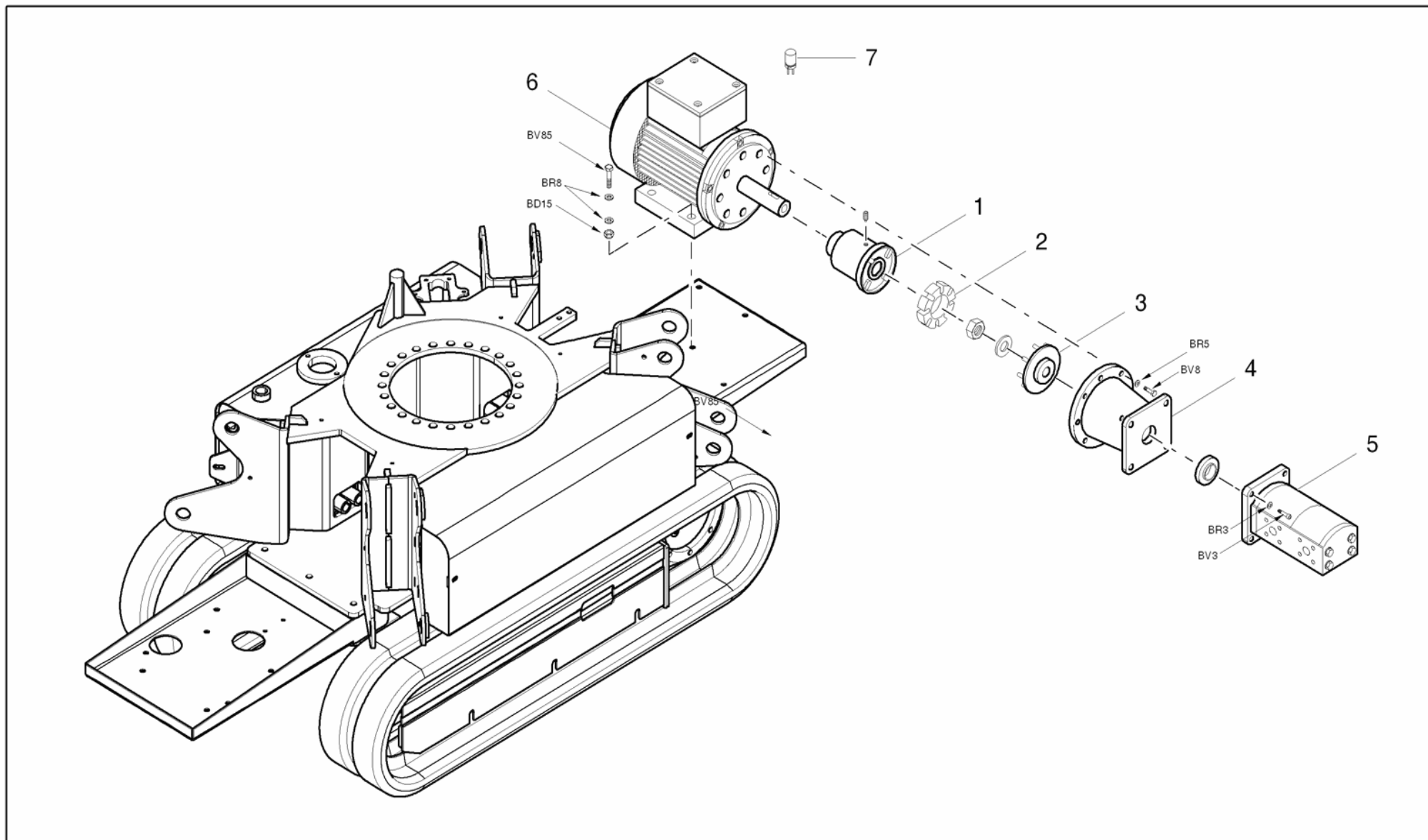

 ELECTRIC MOTOR

MOTOR ELÉCTRICO 

 MOTEUR ÉLECTRIQUE



 MOTORE ELETTRICO
E-MOTOR 
 ELECTRIC MOTOR
MOTOR ELÉCTRICO 
 MOTEUR ÉLECTRIQUE

POS	Codice	Q.tà	 Descrizione	 Description	 Designation	 Benennung	 Descripción
1	05563400	1 NR	semigiunto versione motore elettrico standard	half coupling electric motor standard version	demi-joint	halbverbindung	semi-acoplamiento
1	06997800	1 NR	semigiunto versione litio	half coupling lithium version	demi-joint	halbverbindung	semi-acoplamiento
2	04310100	1 NR	inserto in gomma	rubber insert	insert en caoutchouc	gummieinsatz	inserto de goma
3	04615300	1 NR	giunto	coupling	joint	verbindung	acoplamiento
4	05510200	1 NR	lanterna	lantern	lanterne	buchse	linterna
5	25526300	1 NR	pompa idraulica	hydraulic pump	pompe hydraulique	hydraulikpumpe	bomba hidráulica
5	26328100	1 NR	pompa idraulica per motore 120v	hydraulic pump for electric motor 120v	pompe hydraulique	hydraulikpumpe	bomba hidráulica
6	25510100	1 NR	motore elettrico 230v 50hz	electric motor 230v 50hz	moteur électrique 230v 50hz	e-motor 230v 50hz	motor eléctrico 230v 50hz
6	25576400	1 NR	motore elettrico 110v	electric motor 110v	moteur électrique 110v	e-motor 110v	motor eléctrico 110v
6	26219000	1 NR	motore elettrico 230v 60hz	electric motor 230v 60hz	moteur électrique 230v 60hz	e-motor 230v 60hz	motor eléctrico 230v 60hz
6	26328300	1 NR	motore elettrico 120v 60hz 1.2kw 16a	electric motor 120v 60hz 1.2kw 16a	moteur électrique	e-motor	motor eléctrico
6	26774500	1 NR	motore elettrico lithium 2kw	electric motor lithium 2kw	moteur électrique	e-motor	motor eléctrico





 MOTORE ELETTRICO

E-MOTOR 

 ELECTRIC MOTOR

MOTOR ELÉCTRICO 

 MOTEUR ÉLECTRIQUE

POS Codice	Q.tà	 Descrizione	 Description	 Designation	 Benennung	 Descripcìon
7 2551010001	1 NR	condensatore 230v mf80 d=55	condenser 230v mf80 d=55	condensateur	kondensator	condensador
7 2557640001	1 NR	condensatore 110v mf200 d=65	capacitor 110v mf200 d=65	condensateur	capacitor	capacitor
7 2557640002	1 NR	condensatore 110v mf500	capacitor 110v mf500	condensateur	capacitor	capacitor
7 2632830001	1 NR	condensatore per motore 120v mf120 d=55	capacitor motor 120v mf120 d = 55	condensateur	kondensator	condensador
7 2632830002	1 NR	condensatore per motore 120v mf160 d=60	capacitor motor 120v mf160 d = 60	condensateur	kondensator	condensador

 IMPIANTO IDRAULICO MANDATE E SCARICO

HYDRAULIKANLAGE VORLÄUFE UND RÜCKLAUF 

 SUPPLY AND DISCHARGE HYDRAULIC SYSTEM

INSTALCIÓN HIDRÁULICA IMPULSIONES Y DESCARGA 



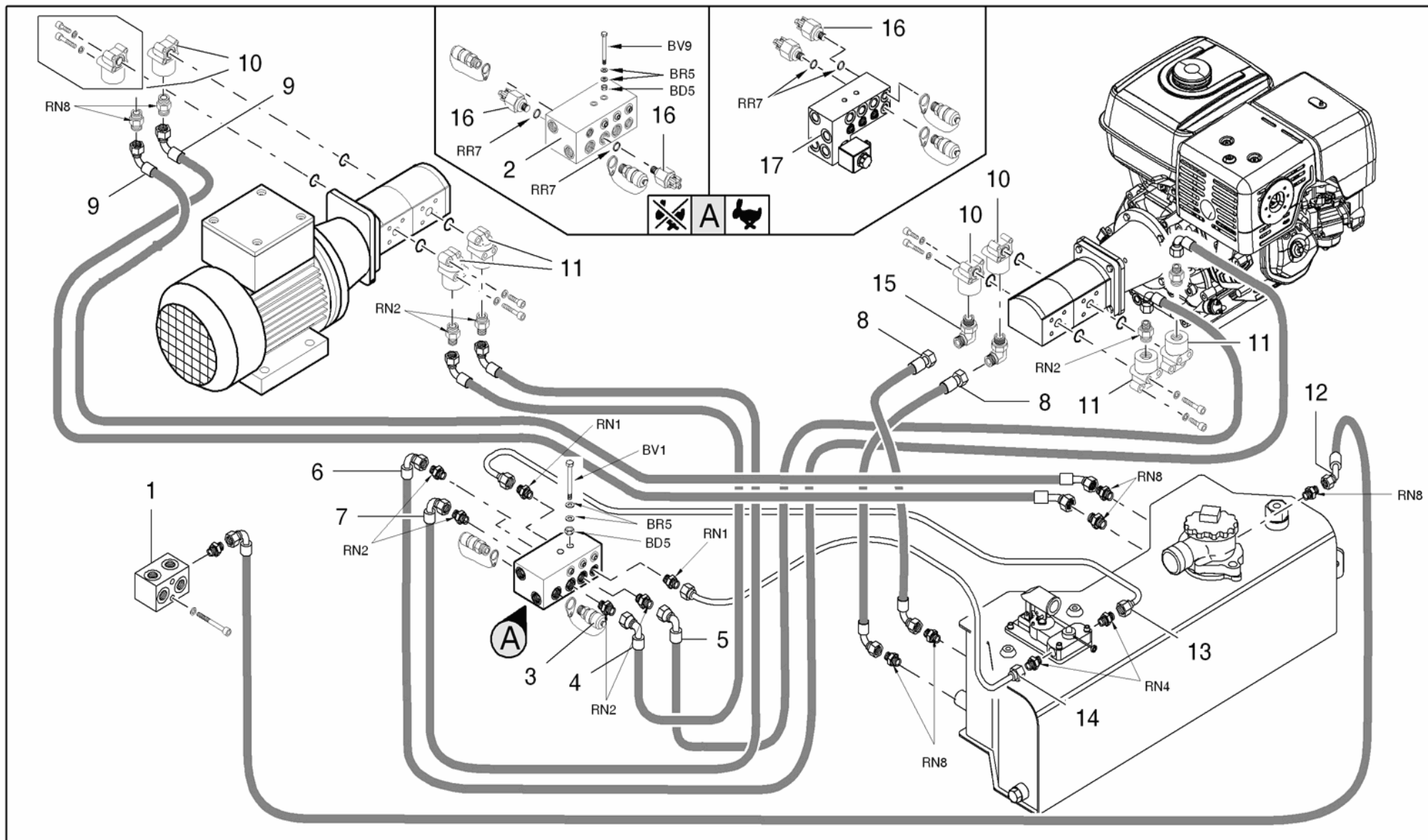

 SYSTÈME HYDRAULIQUE REFOULEMENT ET DÉCHARGEME



 IMPIANTO IDRAULICO MANDATE E SCARICO

 HYDRAULIKANLAGE VORLÄUFE UND RÜCKLAUF 
 SUPPLY AND DISCHARGE HYDRAULIC SYSTEM

 INSTALACIÓN HIDRÁULICA IMPULSIONES Y DESCARGA 
 SYSTÈME HYDRAULIQUE REFOULEMENT ET DÉCHARGEME

POS	Codice	Q.tà	 Descrizione	 Description	 Designation	 Benennung	 Descripción
1	05497500	1 NR	blocchetto tubi	hoses block	bloc tuyaux	rohrblock	bloque tubos
2	15496200	1 NR	valvola idraulica mandate singola velocità	hydraulic valve outlet single speed	valve hydraulique	ventil	válvula hidráulica
3	03014400	2 NR	prova pressione 1/4" g	pressure test 1/4" g	preuve pression 1/4" g	druckkontrolle 1/4" g	prueba presión 1/4" g
4	05857900	1 NR	tubo flessibile	flexible pipe	tuyau flexible	schlauch	tubo flexible
5	05857700	1 NR	tubo flessibile	flexible pipe	tuyau flexible	schlauch	tubo flexible
6	05857800	1 NR	tubo flessibile	flexible pipe	tuyau flexible	schlauch	tubo flexible
7	05858000	1 NR	tubo flessibile	flexible pipe	tuyau flexible	schlauch	tubo flexible
8	05857400	2 NR	tubo flessibile	flexible pipe	tuyau flexible	schlauch	tubo flexible
9	05857300	2 NR	tubo flessibile	flexible pipe	tuyau flexible	schlauch	tubo flexible
10	04845400	2 NR	flangia 1/2" g	flange 1/2" g	bride 1/2" g	flansch 1/2" g	brida 1/2" g
11	04048100	2 NR	flangia 3/8" g	flange 3/8" g	bride 3/8" g	flansch 3/8" g	brida 3/8" g
12	05857500	1 NR	tubo flessibile	flexible pipe	tuyau flexible	schlauch	tubo flexible
13	05841800	1 NR	tubo rigido	rigid pipe	tuyau rigide	rohr	tubo rígido
14	07097200	1 NR	tubo rigido	rigid pipe	tuyau rigide	rohr	tubo rígido
15	04777500	2 NR	raccordo	fitting	raccord	anschluss	conexión





 IMPIANTO IDRAULICO MANDATE E SCARICO

HYDRAULIKANLAGE VORLÄUFE UND RÜCKLAUF 

 SUPPLY AND DISCHARGE HYDRAULIC SYSTEM

INSTALACIÓN HIDRÁULICA IMPULSIONES Y DESCARGA 

 SYSTÈME HYDRAULIQUE REFOULEMENT ET DÉCHARGEME

POS Codice	Q.tà	 Descrizione	 Description	 Designation	 Benennung	 Descripción
16 26964400	2 NR	pressostato	pressure switch	pression	druckwächter	presión
17 15659500	1 NR	valvola idraulica 2 velocità	hydraulic valve high speed	valve hydraulique	valve hydraulique	válvula hidráulica

 IMPIANTO IDRAULICO MANDATE E SCARICO

HYDRAULIKANLAGE VORLÄUFE UND RÜCKLAUF 



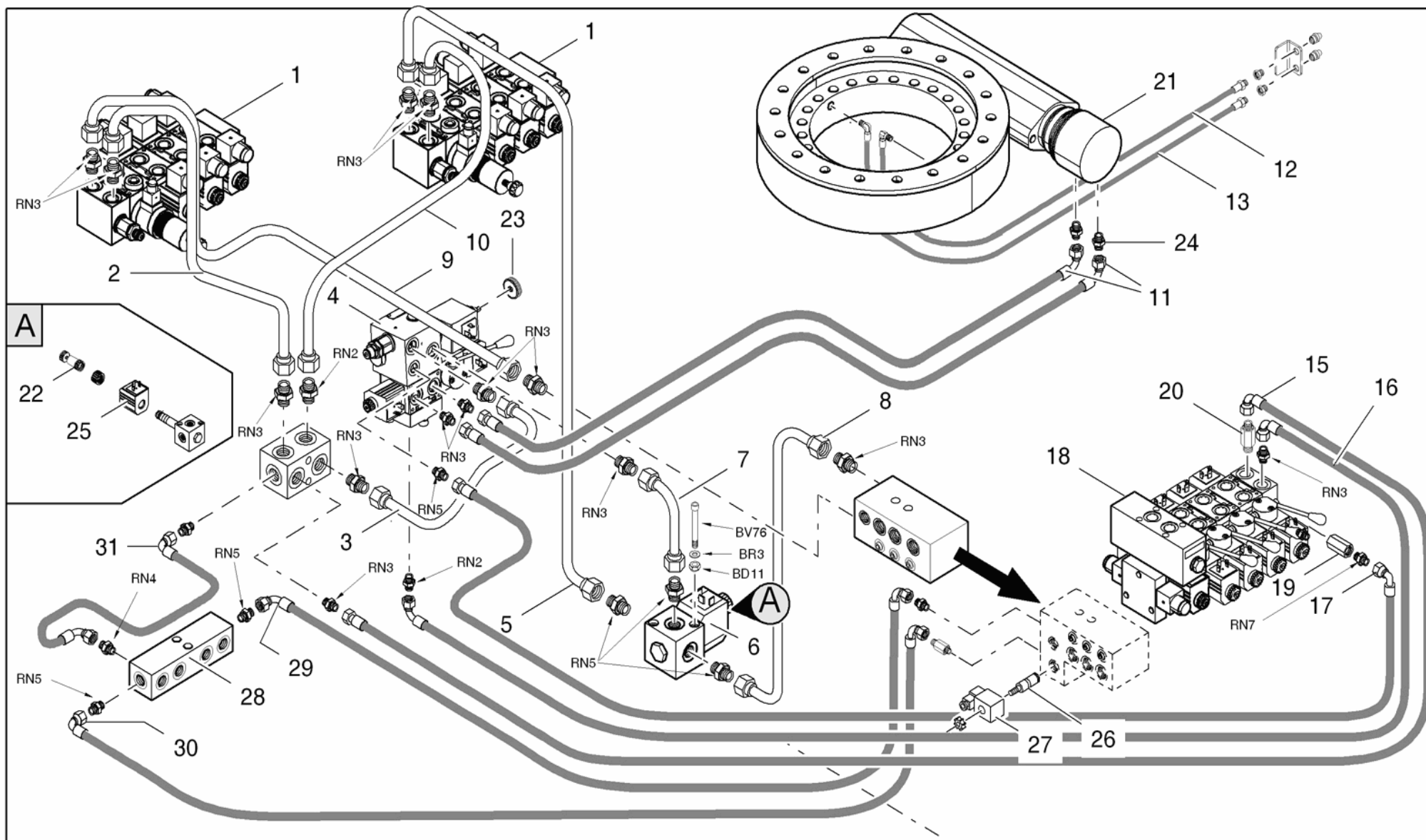

 SUPPLY AND DISCHARGE HYDRAULIC SYSTEM

INSTALCIÓN HIDRÁULICA IMPULSIONES Y DESCARGA 

 SYSTÈME HYDRAULIQUE REFOULEMENT ET DÉCHARGEMENT







 IMPIANTO IDRAULICO MANDATE E SCARICO
HYDRAULIKANLAGE VORLÄUFE UND RÜCKLAUF 
 SUPPLY AND DISCHARGE HYDRAULIC SYSTEM
INSTALACIÓN HIDRÁULICA IMPULSIONES Y DESCARGA 
 SYSTÈME HYDRAULIQUE REFOULEMENT ET DÉCHARGEMENT

POS	Codice	Q.tà	 Descrizione	 Description	 Designation	 Benennung	 Descripción
1	25854200	2 NR	distributore idraulico 3 elementi traini	hydraulic distributor 3 elements tracks	distributeur hydraulique	hydr. regelsteuergerät	distribuidor hidráulico
1	27394700	2 NR	distributore idraulico carro 3 elementi con pulsante a molla	hydraulic distributor 3 elements tracks with spring button	distributeur hydraulique	hydr. regelsteuergerät	distribuidor hidráulico
2	05847200	1 NR	tubo rigido	rigid pipe	tuyau rigide	rohr	tubo rígido
3	05842000	1 NR	tubo rigido	rigid pipe	tuyau rigide	rohr	tubo rígido
4	26278100	1 NR	distributore idraulico proporzionale parte aerea	distributor proportional hydraulic aerial part	distributeur hydraulique	hydr. regelsteuergerät	distribuidor hidráulico
5	05847300	1 NR	tubo rigido	rigid pipe	tuyau rigide	rohr	tubo rígido
6	25732900	1 NR	deviatore idraulico	hydraulic diverter	déviateur	wechselschlter	desviador
7	05847500	1 NR	tubo rigido	rigid pipe	tuyau rigide	tuyau rigide rohr	tubo rígido
8	05848300	1 NR	tubo rigido	rigid pipe	tuyau rigide	rohr	tubo rígido
9	05847100	1 NR	tubo rigido	rigid pipe	tuyau rigide	rohr	tubo rígido
10	05847400	1 NR	tubo rigido	rigid pipe	tuyau rigide	rohr	tubo rígido
11	05858400	2 NR	tubo flessibile	flexible pipe	tuyau flexible	schlauch	tubo flexible
12	05857100	1 NR	tubo flessibile	flexible pipe	tuyau flexible	schlauch	tubo flexible

 IMPIANTO IDRAULICO MANDATE E SCARICO

 HYDRAULIKANLAGE VORLÄUFE UND RÜCKLAUF 
 SUPPLY AND DISCHARGE HYDRAULIC SYSTEM

 INSTALACIÓN HIDRÁULICA IMPULSIONES Y DESCARGA 
 SYSTÈME HYDRAULIQUE REFOULEMENT ET DÉCHARGEMENT

POS Codice	Q.tà	 Descrizione	 Description	 Designation	 Benennung	 Descripción
13 05857200	1 NR	tubo flessibile	flexible pipe	tuyau flexible	schlauch	tubo flexible
15 05858600	1 NR	tubo flessibile	flexible pipe	tuyau flexible	schlauch	tubo flexible
16 06294700	1 NR	tubo flessibile	flexible pipe	tuyau flexible	schlauch	tubo flexible
17 06295000	1 NR	tubo flessibile	flexible pipe	tuyau flexible	schlauch	tubo flexible
18 26278200	1 NR	distributore idraulico parte aerea con leve	hydraulic distributor aerial part with levers	distributeur hydraulique	hydr. regelsteuergerät	distribuidor hidráulico
19 05912600	1 NR	colonna femmina 1/4"- femmina 1/4" unidirezionale	female thread 1/4" - 1/4 female" unidirectional	goujon	schraubbolzen	prolongación
20 05189200	1 NR	raccordo speciale 12l-3/8" g h=28	special fitting 12l-3/8 "h g = 28	raccord	anschluss	conexión
21 26130800	1 NR	motore di rotazione	rotary motor	moteur de rotation	rotationsmotor	motor de rotación
22 25908400	1 NR	dispositivo di comando manuale idraulico	hand control hydraulic	commande hydraulique	hydraulischer antrieb	comando hidráulico
23 05977600	1 NR	vite di regolazione	adjustment screw	souape proportionelle	verstellungsschraub e	volante de control
24 06841300	2 NR	raccordo 1/2" - 10l ø=1mm	fitting 1/2" - 10l ø=1mm	raccord 1/2" - 10l ø=1mm	anschluss 1/2" - 10l ø=1mm	conexión 1/2" - 10l ø=1mm
24 06903100	2 NR	raccordo 1/2" - 10l ø=0.85mm	fitting 1/2" - 10l ø=0.85mm	raccord 1/2" - 10l ø=0.85mm	anschluss 1/2" - 10l ø=0.85mm	conexión 1/2" - 10l ø=0.85mm





 IMPIANTO IDRAULICO MANDATE E SCARICO

HYDRAULIKANLAGE VORLÄUFE UND RÜCKLAUF 

 SUPPLY AND DISCHARGE HYDRAULIC SYSTEM

INSTALACIÓN HIDRÁULICA IMPULSIONES Y DESCARGA 

 SYSTÈME HYDRAULIQUE REFOULEMENT ET DÉCHARGEMENT

POS Codice	Q.tà	 Descrizione	 Description	 Designation	 Benennung	 Descripción
25 05913800	1 NR	bobina per on-off	coil for on-off	bobine	spule	bobina
26 1647820003	1 NR	elettrovalvola	solenoid valve	électrovanne	magnetventil	electroválvula
28 04707700	1 NR	collettore	manifold	collecteur	kollektor	colector
29 05976200	1 NR	tubo flessibile	flexible pipe	tuyau flexible	schlauch	tubo flexible
30 05976300	1 NR	tubo flessibile	flexible pipe	tuyau flexible	schlauch	tubo flexible
31 05975800	1 NR	tubo flessibile	flexible pipe	tuyau flexible	schlauch	tubo flexible

 **DISTRIBUTORI IDRAULICI**

 **HYDRAULIC DISTRIBUTORS**



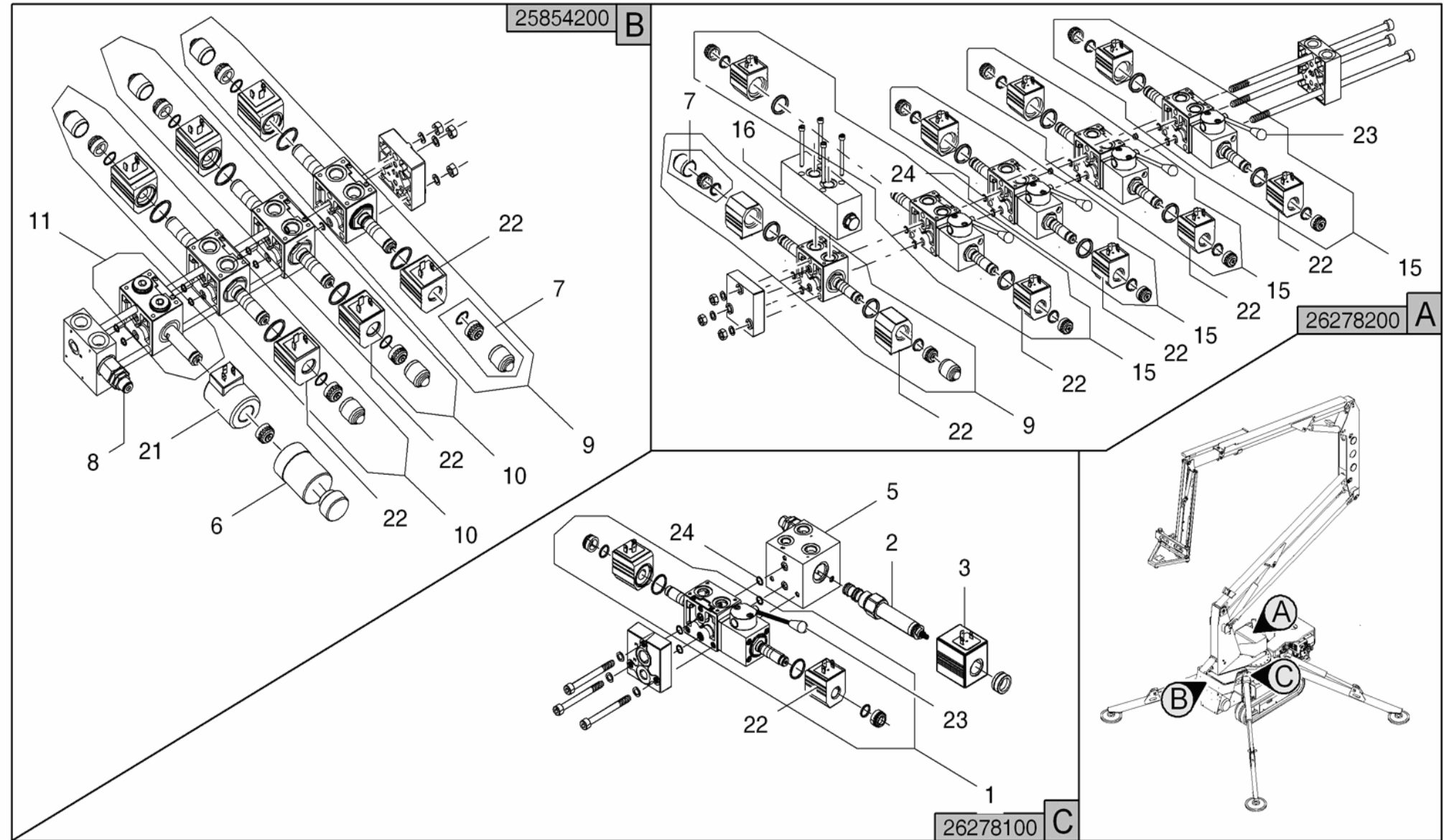

 **DISTRIBUTEURS HYDRAULIQUES**

HYDRAULISCHE REGELSTEUERGERÄTE 





DISTRIBUIDORES HIDRÁULICOS 



 DISTRIBUTORI IDRAULICI
HYDRAULISCHE REGELSTEUERGERÄTE 
 HYDRAULIC DISTRIBUTORS
DISTRIBUIDORES HIDRÁULICOS 
 DISTRIBUTEURS HYDRAULIQUES

POS Codice	Q.tà	 Descrizione	 Description	 Designation	 Benennung	 Descripción
1 2627800002	1 NR	sezione distributore ab chiuso rotazione aerea completo di leva e bobina	section distributor ab closed complete of the lever and coil	section distributeur	regelsteuergerätab schn.	sección distribuidor
2 2627800003	1 NR	valvola proporzionale (cartuccia) parte aerea	proportional valve (cartridge) aerial part	électrovanne	magnetventil	electroválvula
5 2666800009	1 NR	corpo valvola proporzionale	proportional valve body	corps	gehäuse	cuerpo
6 07324900	1 NR	comando manuale emergenza con ritorno a molla	emergency maual control with spring return	commande manuel d'urgence	manuelles antrieb für notstand	mando manual de emergencia
6 2585420001	1 NR	comando manuale emergenza	emergency maual control	commande manuel d'urgence	manuelles antrieb für notstand	mando manual de emergencia
7 2585560009	6 NR	pulsante	button	bouton	druckknopf	botón
7 2585560009	2 NR	pulsante	button	bouton	druckknopf	botón
8 2645900002	1 NR	cartuccia valvola di massima pressione	cartridge pressure relief valve	cartouche huile hydr.	hydrauliköleinsatz	cartucho aceite hydr.
9 2585560003	1 NR	sezione distributore	valve block section	section distributeur	regelsteuergerätab schnitt	sección distribuidor
10 2585560002	2 NR	sezione distributore	valve block section	section distributeur	regelsteuergerätab schnitt	sección distribuidor

 DISTRIBUTORI IDRAULICI
HYDRAULISCHE REGELSTEUERGERÄTE 
 HYDRAULIC DISTRIBUTORS
DISTRIBUIDORES HIDRÁULICOS 
 DISTRIBUTEURS HYDRAULIQUES

POS Codice	Q.tà	 Descrizione	 Description	 Designation	 Benennung	 Descripcìon
11 2585420002	1 NR	valvola idraulica	hydraulic valve	valve hydraulique	valve hydraulique	válvula hidráulica
11 2729900001	1 NR	valvola proporzionale traini con bobina e senza comando manuale a molla	proportional valve for track with coil and without manual spring	valve hydraulique	hydraulikventil	vàlvula hidràulica
15 2627810001	1 NR	sezione distributore	valve block section	section distributeur	regelsteuergerätab schn.	sección distribuidor
16 2585560004	1 NR	blocco valvola bilanciamento bracci su distributori parte aerea	balancing valve block booms of distributors aerial part	bloc soupape	ventilsperre	bloque válvula
21 06037100	1 NR	bobina per valvola proporzionale parte carro	coil proportional valve for undercarriage	bobine	spule	bobina
22 05913800	2 NR	bobina per on-off	coil for on-off	bobine	spule	bobina
22 05913800	6 NR	bobina per on-off	coil for on-off	bobine	spule	bobina
22 05913800	10 NR	bobina per on-off	coil for on-off	bobine	spule	bobina
23 07300200	4 NR	leva distributore	lever hydraulic distributor	levier	hebel	palanca
24 2585560005	25 NR	o-ring	o-ring	o-ring	o-ring	o-ring





 DISTRIBUTORI IDRAULICI

HYDRAULISCHE REGELSTEUERGERÄTE 

 HYDRAULIC DISTRIBUTORS

DISTRIBUIDORES HIDRÁULICOS 

 DISTRIBUTEURS HYDRAULIQUES

POS Codice	Q.tà	 Descrizione	 Description	 Designation	 Benennung	 Descripcìon
25 06037900	1 NR	bobina per valvola proporzionale parte aerea	coil proportional valve for aerial part	bobine	spule	bobina

 IMPIANTO IDRAULICO TRAZIONE

HYDRAULIKANLAGE ANTRIEB 

 HYDRAULIC SYSTEM FOR TRACTION

INSTALACIÓN HIDRÁULICA TRACCIÓN 

 SYSTÈME HYDRAULIQUE DE TRACTION

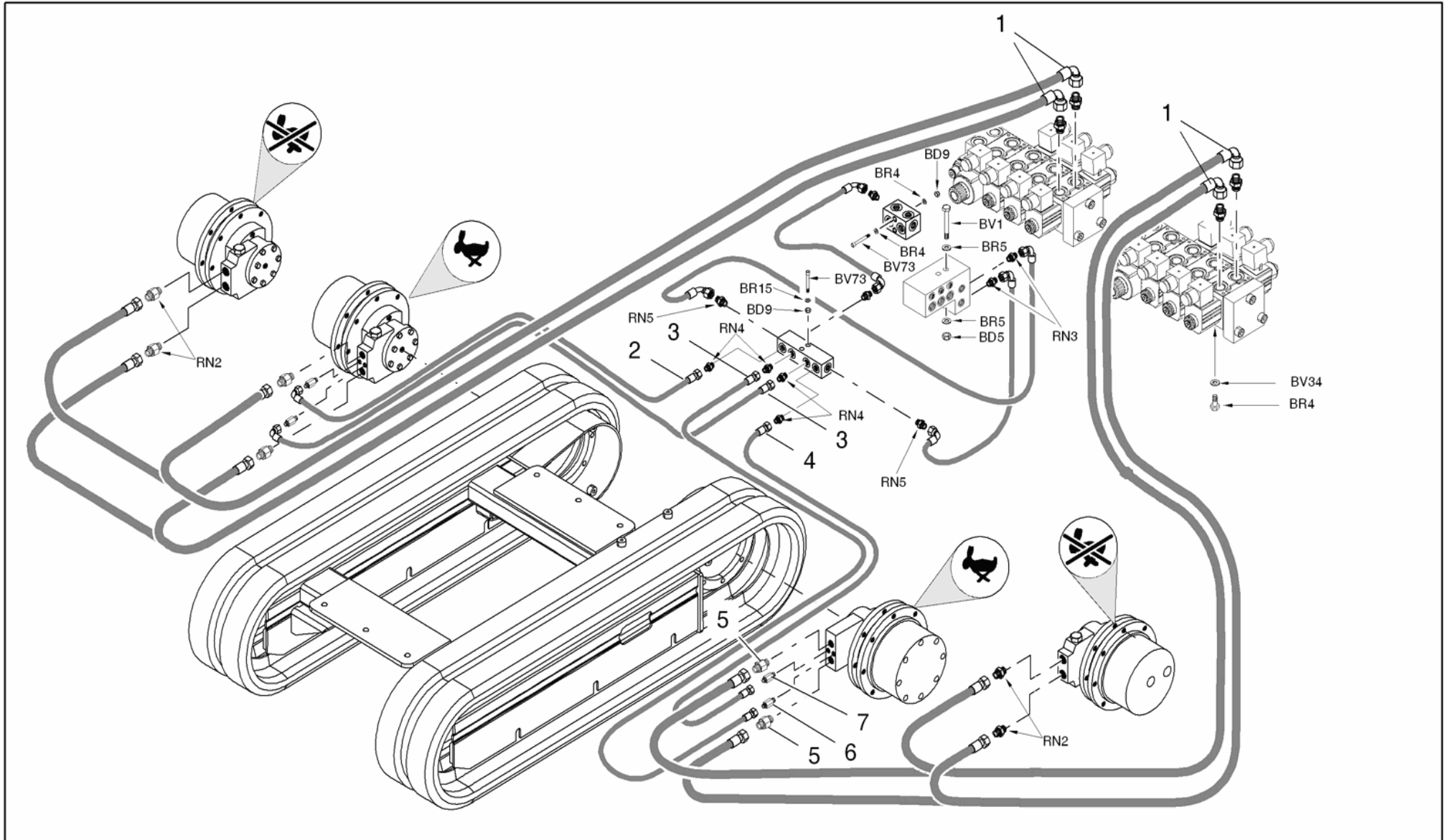





 IMPIANTO IDRAULICO TRAZIONE

HYDRAULIKANLAGE ANTRIEB 

 HYDRAULIC SYSTEM FOR TRACTION

INSTALACIÓN HIDRÁULICA TRACCIÓN 

 SYSTÈME HYDRAULIQUE DE TRACTION

POS Codice	Q.tà	 Descrizione	 Description	 Designation	 Benennung	 Descripción
1 05857600	4 NR	tubo flessibile	flexible pipe	tuyau flexible	schlauch	tubo flexible
2 05976000	1 NR	tubo flessibile	flexible pipe	tuyau flexible	schlauch	tubo flexible
3 05975900	2 NR	tubo flessibile	flexible pipe	tuyau flexible	schlauch	tubo flexible
4 05976100	1 NR	tubo flessibile	flexible pipe	tuyau flexible	schlauch	tubo flexible
5 05093900	4 NR	raccordo 12l-3/8 jis esagono 22 h40	12l-fitting 3/8 jis hex22 h40	raccord	anschluss	conexión
6 05717800	2 NR	raccordo 1/8"-8l jis h=60	fitting 1/8"-8l jis h = 60	raccord	anschluss	conexión
7 06244000	2 NR	raccordo 1/8"-8l jis h=38	fitting 1/8"-8l jis h=38	raccord	anschluss	conexión

 IMPIANTO IDRAULICO STABILIZZATORI

ABSTÜTZUNG ABSTÜTZUNGSHYDRAULIKZYLIND 

 STABILIZERS HYDRAULIC SYSTEM

INSTALACIÓN HIDRAULICA ESTABILIZADORS 

 INSTALLATION HYDRAULIQUE STABILISATERS

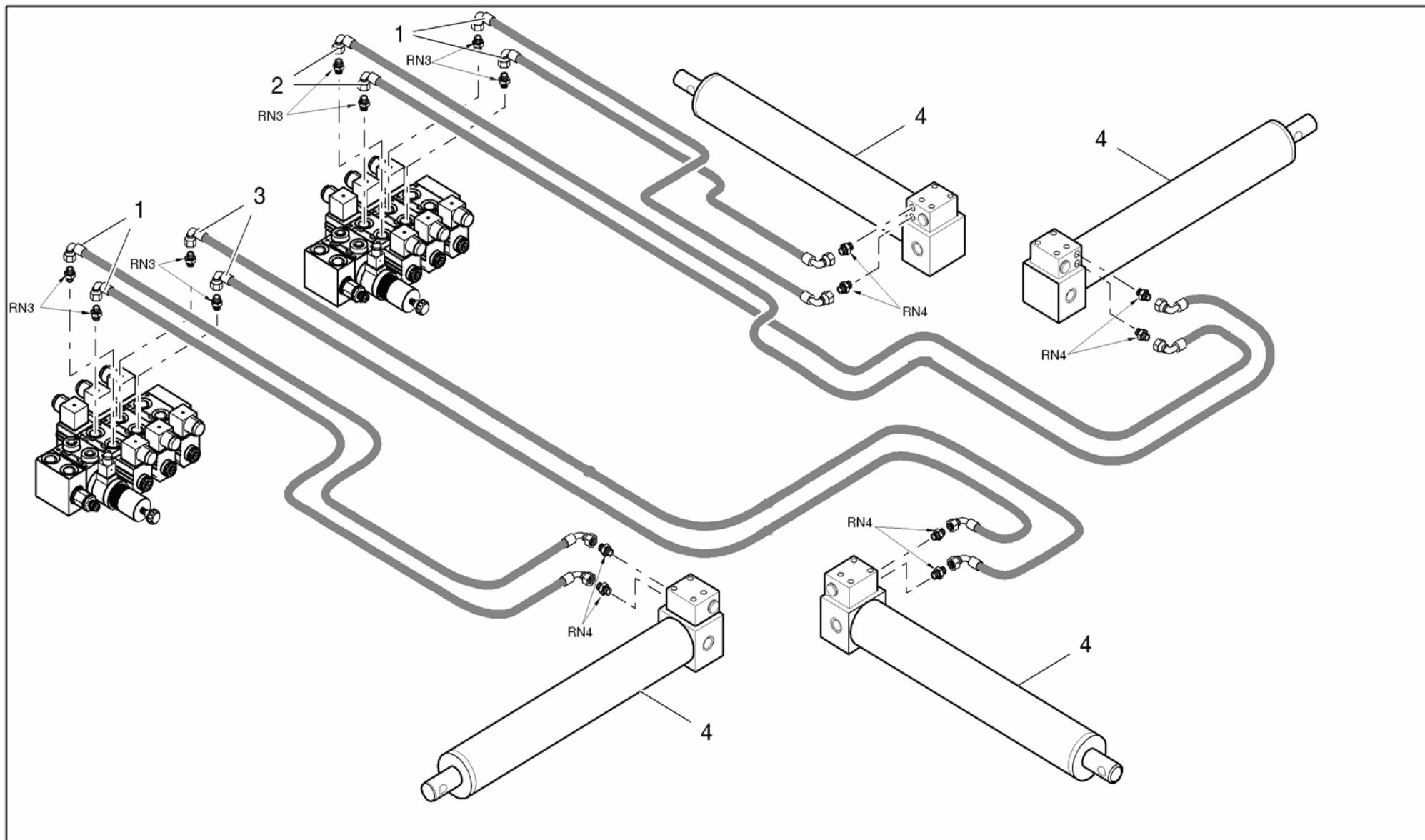





 IMPIANTO IDRAULICO STABILIZZATORI

ABSTÜTZUNG ABSTÜTZUNGSHYDRAULIKZYLIND 

 STABILIZERS HYDRAULIC SYSTEM

INSTALACIÓN HIDRAULICA ESTABILIZADORS 

 INSTALLATION HYDRAULIQUE STABILISATERS

POS Codice	Q.tà	 Descrizione	 Description	 Designation	 Benennung	 Descripcìon
1 05858200	4 NR	tubo flessibile	flexible pipe	tuyau flexible	schlauch	tubo flexible
2 05858300	2 NR	tubo flessibile	flexible pipe	tuyau flexible	schlauch	tubo flexible
3 05858100	2 NR	tubo flessibile	flexible pipe	tuyau flexible	schlauch	tubo flexible
4 26281800	4 NR	cilindro	cylinder	cylinder	zylinder	cilindro





 IMPIANTO IDRAULICO 1-2 BRACCI

HYDRAULIKANLAGE 1-2 ARM 

 1-2 ARMS HYDRAULIC SYSTEM

INSTALACIÓN HIDRÁULICA 1-2 BRAZOS 

 SYSTÈME HYDRAULIQUE 1-2 BRAS

POS	Codice	Q.tà	 Descrizione	 Description	 Designation	 Benennung	 Descripción
1	05859000	2 NR	tubo flessibile	flexible pipe	tuyau flexible	schlauch	tubo flexible
2	26905200	1 NR	cilindro	cylinder	cylinder	zylinder	cilindro
3	26905100	1 NR	cilindro	cylinder	cylinder	zylinder	cilindro
4	06294800	1 NR	tubo flessibile	flexible pipe	tuyau flexible	schlauch	tubo flexible
5	05912500	1 NR	colonna	stud	goujon	schraubbolzen	prolongación
6	05912400	1 NR	valvola idraulica	hydraulic valve	valve hydraulique	valve hydraulique	válvula hidráulica
7	06294600	1 NR	tubo flessibile	flexible pipe	tuyau flexible	schlauch	tubo flexible





 IMPIANTO IDRAULICO SFILO

TELESKOPHYDRAULIK 

 TELESCOPIC HYDRAULIC SYSTEM

INSTALACIÓN EXTENSIÓN HIDRÁULICA 

 TELESCOPIQUE HIDRAULIQUE

POS Codice	Q.tà	 Descrizione	 Description	 Designation	 Benennung	 Descripcìon
1 06295100	1 NR	tubo flessibile	flexible pipe	tuyau flexible	schlauch	tubo flexible
2 05502100	1 NR	anello	ring	bague	ring	anillo
3 26281900	1 NR	cilindro	cylinder	cylinder	zylinder	cilindro
4 06295200	1 NR	tubo flessibile	flexible pipe	tuyau flexible	schlauch	tubo flexible

 IMPIANTO JIB

ZYLINDER JIB ARM 

 JIB HYDRAULIC SYSTEM

INSTALACIÓN HIDRÁULICA JIB 

 SYSTÈME HYDRAULIQUE JIB

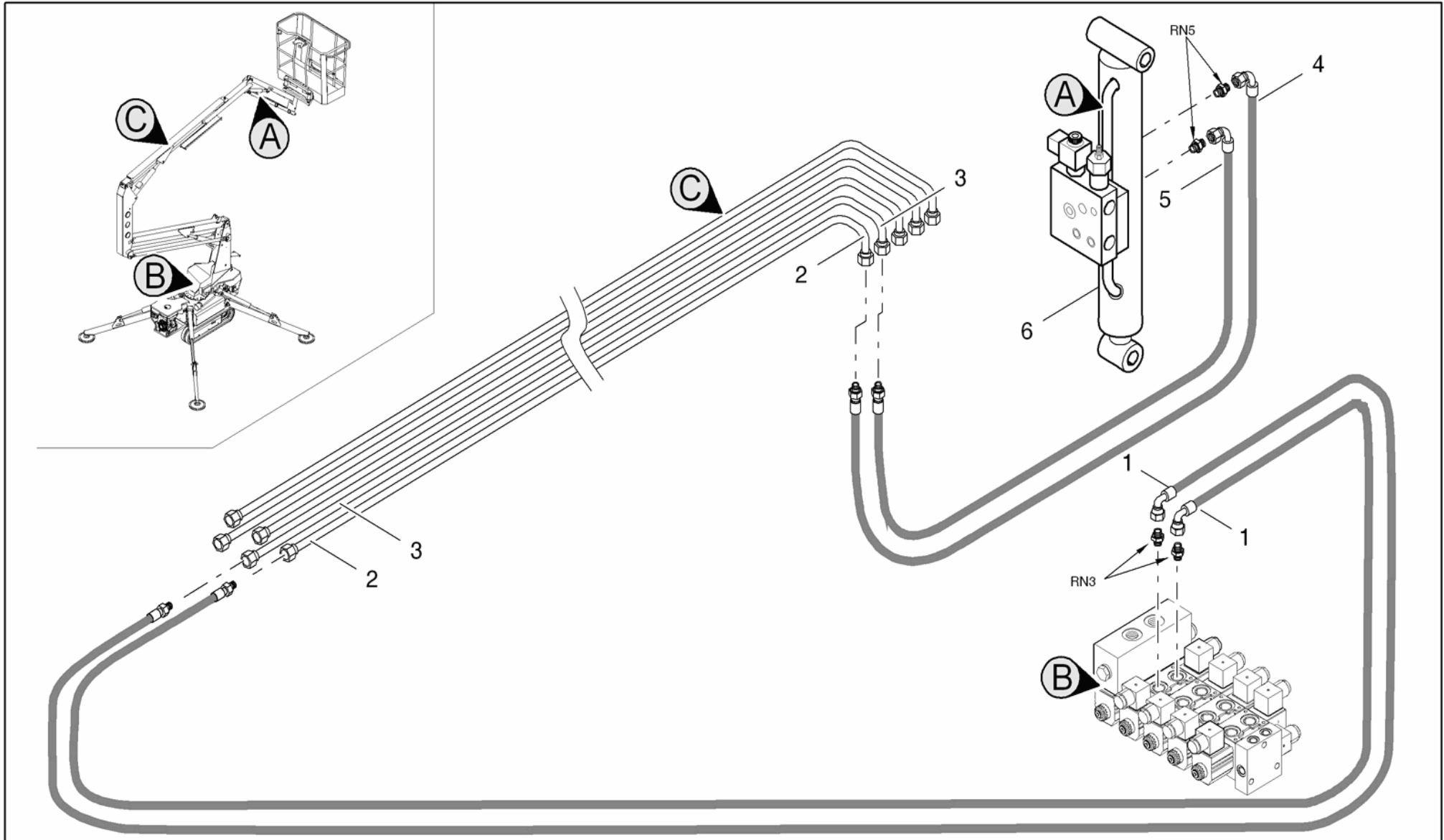







 IMPIANTO JIB

ZYLINDER JIB ARM 

 JIB HYDRAULIC SYSTEM

INSTALACIÓN HIDRÁULICA JIB 

 SYSTÈME HYDRAULIQUE JIB

POS	Codice	Q.tà	 Descrizione	 Description	 Designation	 Benennung	 Descripción
1	05858800	2 NR	tubo flessibile	flexible pipe	tuyau flexible	schlauch	tubo flexible
2	05848000	1 NR	tubo rigido	rigid pipe	tuyau rigide	rohr	tubo rígido
3	05847900	1 NR	tubo rigido	rigid pipe	tuyau rigide	rohr	tubo rígido
4	05859600	1 NR	tubo flessibile	flexible pipe	tuyau flexible	schlauch	tubo flexible
5	05859700	1 NR	tubo flessibile	flexible pipe	tuyau flexible	schlauch	tubo flexible
6	26281700	1 NR	cilindro	cylinder	cylinder	zylinder	cilindro

 IMPIANTO IDRAULICO LIVELLAMENTO

 LEVELING CYLINDERS HYDRAULIC SYSTEM

 SYSTÈME HYDRAULIQUE CYLINDRES BRAS

HYDRAULIKANLAGE ZYLINDER ARM 

INSTALACIÓN HIDRÁULICA CILINDROS BRAZOS 

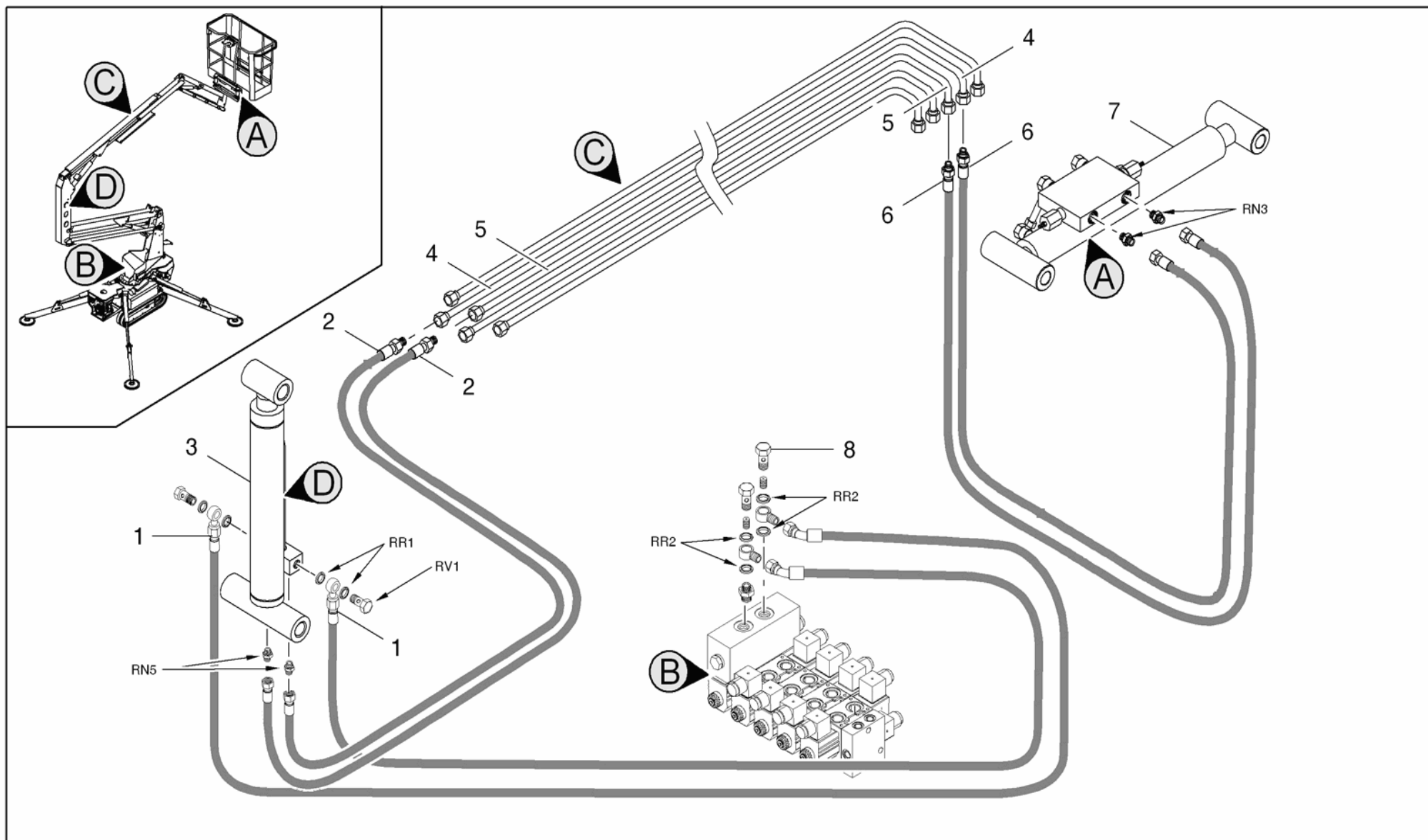





 IMPIANTO IDRAULICO LIVELLAMENTO



HYDRAULIKANLAGE ZYLINDER ARM 



 LEVELING CYLINDERS HYDRAULIC SYSTEM

INSTALACIÓN HIDRÁULICA CILINDROS BRAZOS 

 SYSTÈME HYDRAULIQUE CYLINDRES BRAS

POS	Codice	Q.tà	 Descrizione	 Description	 Designation	 Benennung	 Descripcìon
1	05859200	2 NR	tubo flessibile	flexible pipe	tuyau flexible	schlauch	tubo flexible
2	05859300	2 NR	tubo flessibile	flexible pipe	tuyau flexible	schlauch	tubo flexible
3	26281500	1 NR	cilindro	cylinder	cylinder	zylinder	cilindro
4	05847700	1 NR	tubo rigido	rigid pipe	tuyau rigide	rohr	tubo rìgido
5	05847800	1 NR	tubo rigido	rigid pipe	tuyau rigide	rohr	tubo rìgido
6	05859800	2 NR	tubo flessibile	flexible pipe	tuyau flexible	schlauch	tubo flexible
7	26281600	1 NR	cilindro	cylinder	cylinder	zylinder	cilindro
8	05909300	2 NR	vite	screw	vis	schraube	tornillo

 IMPIANTO IDRAULICO ARIA COMPRESSA
 COMPRESSED AIR HYDRAULIC SYSTEM
 SYSTÈME HYDRAULIQUE AIR COMPRIMÉ

HYDRAULIKANLAGE DRUCKLUFT 
 INSTALACIÓN HIDRÁULICA AIRE COMPRIMIDO 

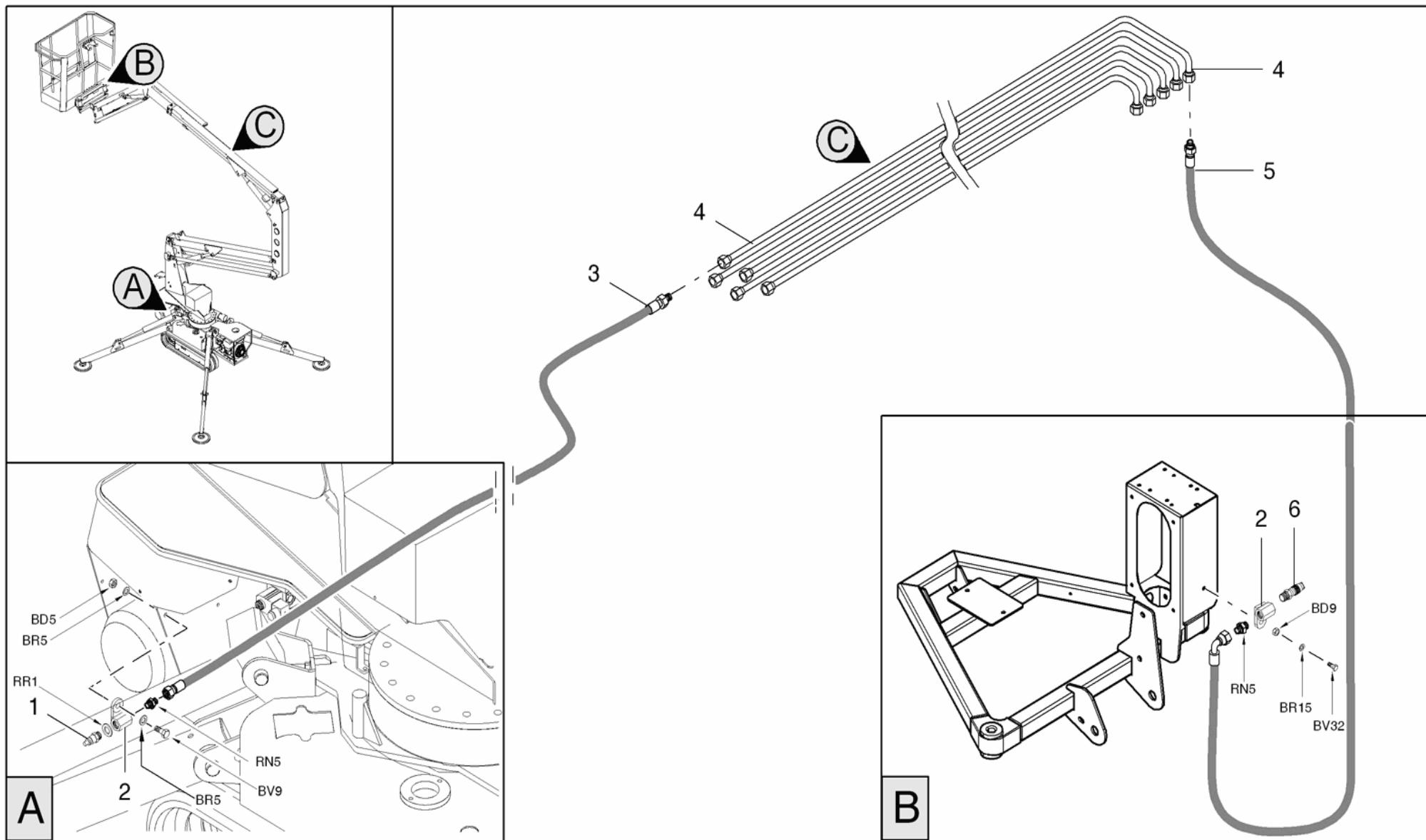





 IMPIANTO IDRAULICO ARIA COMPRESSA

HYDRAULIKANLAGE DRUCKLUFT 

 COMPRESSED AIR HYDRAULIC SYSTEM

INSTALACIÓN HIDRÁULICA AIRE COMPRIMIDO 

 SYSTÈME HYDRAULIQUE AIR COMPRIMÉ

POS Codice	Q.tà	 Descrizione	 Description	 Designation	 Benennung	 Descripción
1 05509900	1 NR	innesto rapido	quick coupling	raccord rapide	schnellkupplung	conexión rápida
2 04845100	1 NR	supporto	support	support	halterung	soporte
3 06294900	1 NR	tubo flessibile	flexible pipe	tuyau flexible	schlauch	tubo flexible
4 05847600	1 NR	tubo rigido	rigid pipe	tuyau rigide	rohr	tubo rígido
5 05859900	1 NR	tubo flessibile	flexible pipe	tuyau flexible	schlauch	tubo flexible
6 05580200	1 NR	rubinetto	faucet	robinet	wasserhahn	grifo

 CILINDRI

ZYLINDER 



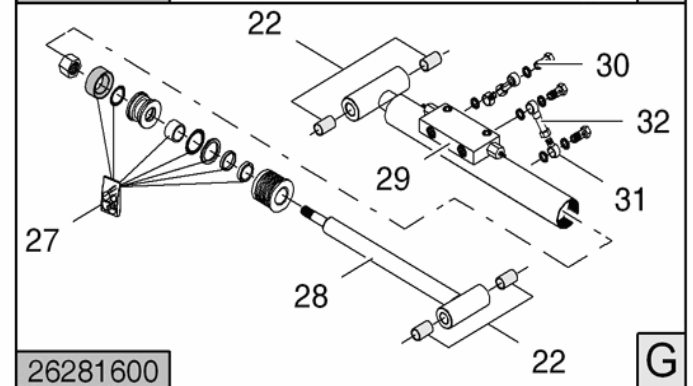
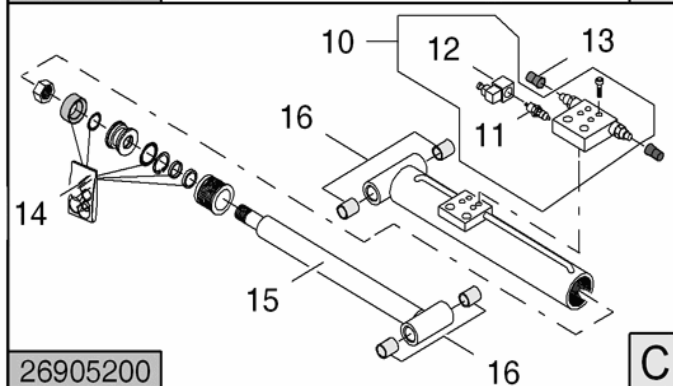
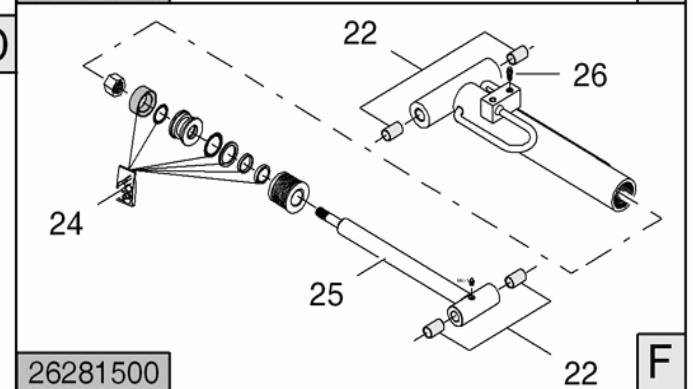
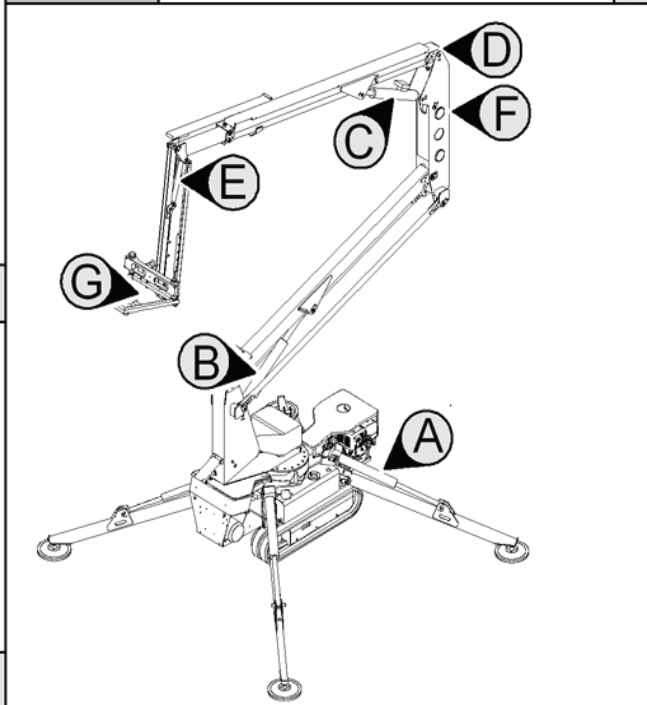
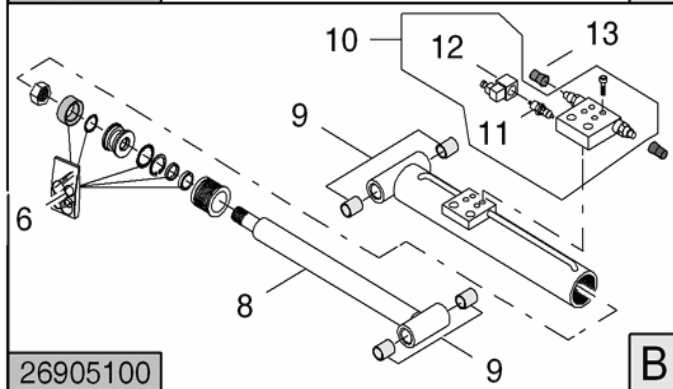
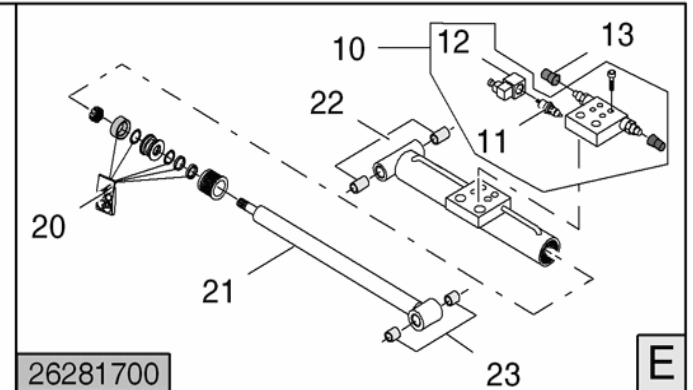
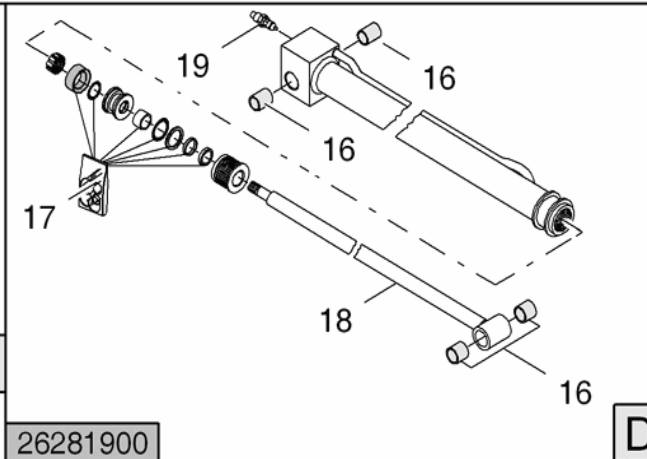
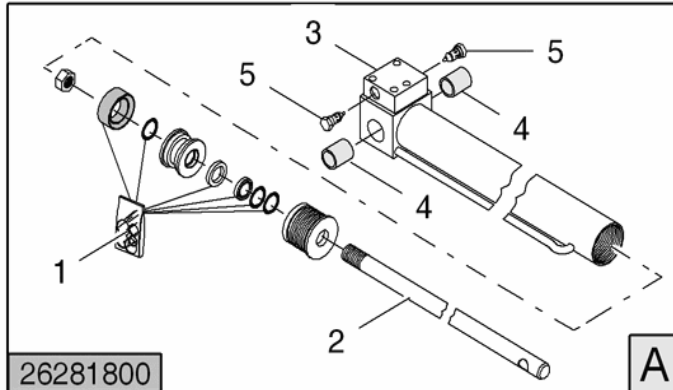

 CYLINDERS

CILINDROS 





 CYLINDRES



 CILINDRIZYLINDER  CYLINDERSCILINDROS  CYLINDRES

POS Codice	Q.tà	 Descrizione	 Description	 Designation	 Benennung	 Descripción
1 2628180001	1 NR	kit guarnizioni	gasket kit	kit joints	dichtungssatz	kit guarniciones
2 2581250002	1 NR	stelo	rod	tige	schaft	vástago
3 2581250009	1 NR	blocchetto	block	bloc	block	bloque
4 2628180003	2 NR	boccola	bush	douille	buchse	casquillo
5 1541150011	2 NR	valvola idraulica	hydraulic valve	valve hydraulique	valve hydraulique	válvula hidráulica
6 2690510001	1 NR	kit guarnizioni	gasket kit	kit joints	dichtungssatz	kit guarniciones
8 2628130001	1 NR	stelo	rod	tige	schaft	vástago
9 2628130003	4 NR	boccola	bush	douille	buchse	casquillo
10 26119300	1 NR	valvola idraulica	hydraulic valve	valve hydraulique	valve hydraulique	válvula hidráulica
11 0552550001	1 NR	elettrovalvola	solenoid valve	électrovanne	magnetventil	electroválvula
12 0552550003	1 NR	bobina	coil	bobine	spule	bobina
13 05576200	12 NR	protezione	protection	protection	schutz	protección
13 05576200	6 NR	protezione	protection	protection	schutz	protección
14 2690520001	1 NR	kit guarnizioni	gasket kit	kit joints	dichtungssatz	kit guarniciones
15 2690520002	1 NR	stelo	rod	tige	schaft	vástago
16 2627880005	1 NR	boccola	bush	douille	buchse	casquillo

 CILINDRIZYLINDER  CYLINDERSCILINDROS  CYLINDRES

POS Codice	Q.tà	 Descrizione	 Description	 Designation	 Benennung	 Descripción
17 2628190001	1 NR	kit guarnizioni	gasket kit	kit joints	dichtungssatz	kit guarniciones
18 2628190003	1 NR	stelo	rod	tige	schaft	vástago
19 05525600	1 NR	valvola idraulica	hydraulic valve	valve hydraulique	valve hydraulique	válvula hidráulica
20 2628170001	1 NR	kit guarnizioni	gasket kit	kit joints	dichtungssatz	kit guarniciones
21 2628170002	1 NR	stelo	rod	tige	schaft	vástago
22 2627890006	2 NR	boccola	bush	douille	buchse	casquillo
23 2627910006	2 NR	boccola	bush	douille	buchse	casquillo
24 2628150001	1 NR	kit guarnizioni	gasket kit	kit joints	dichtungssatz	kit guarniciones
25 2628150002	1 NR	stelo	rod	tige	schaft	vástago
26 2588290008	2 NR	vite	screw	vis	schraube	tornillo
27 2628160001	1 NR	kit guarnizioni	gasket kit	kit joints	dichtungssatz	kit guarniciones
28 2628160002	1 NR	stelo	rod	tige	schaft	vástago
29 2581570009	1 NR	valvola idraulica	hydraulic valve	valve hydraulique	valve hydraulique	válvula hidráulica
30 2581570013	1 NR	vite	screw	vis	schraube	tornillo
31 2581570011	1 NR	raccordo	fitting	raccord	anschluss	conexión
32 2581570012	1 NR	raccordo	fitting	raccord	anschluss	conexión

 COMPONENTI IMPIANTO ELETTRICO

KOMPONENTEN ELEKTROANLAGE 

 ELECTRICAL SYSTEM COMPONENTS

COMPONENTES INSTALACIÓN ELÉCTRICA 



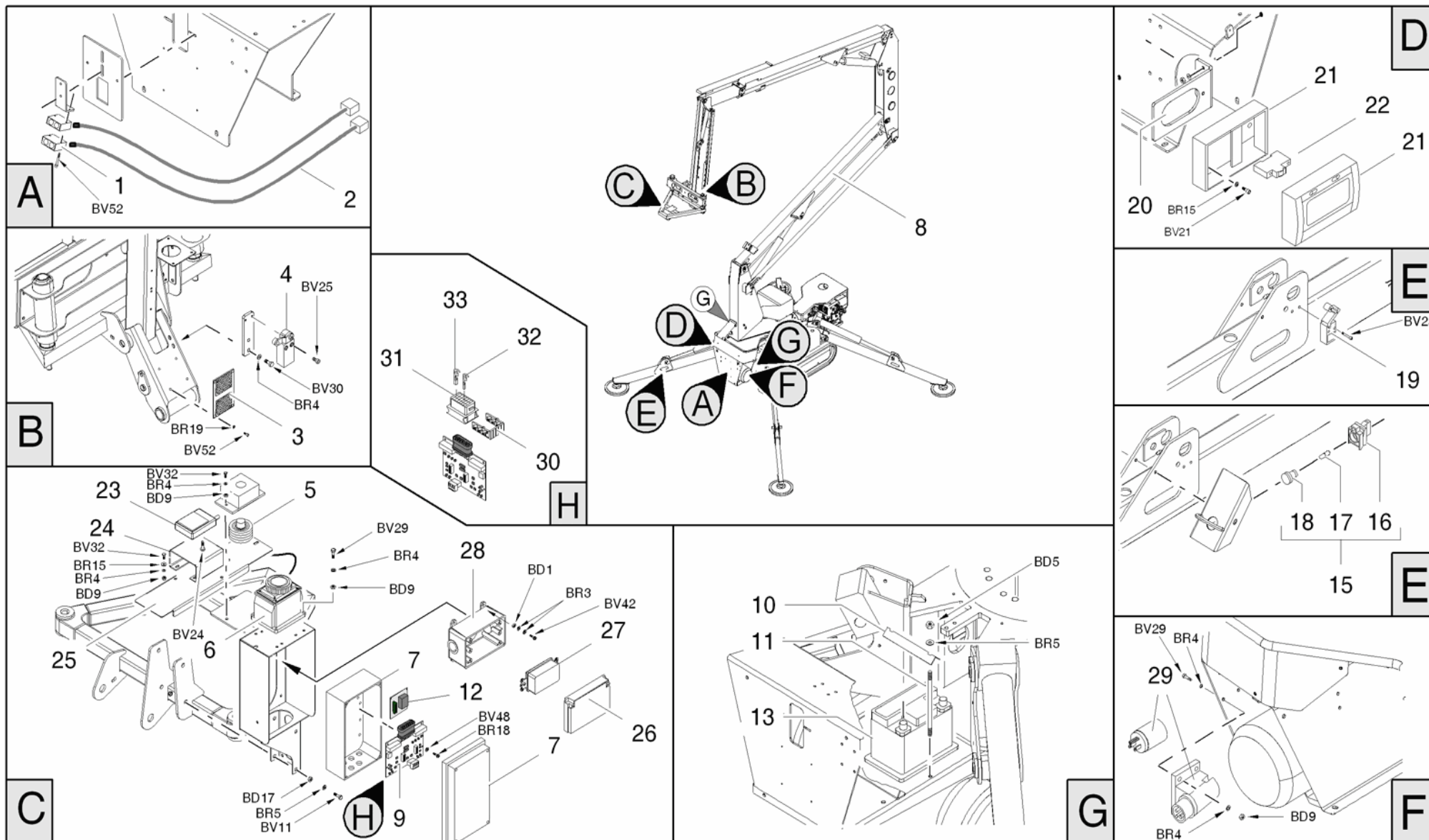

 COMPOSANTS INSTALLATION ÉLECTRIQUE



 COMPONENTI IMPIANTO ELETTRICO

 KOMponenten ELEKTROANLAGE 
 ELECTRICAL SYSTEM COMPONENTS

 COMPONENTES INSTALACIÓN ELÉCTRICA 
 COMPOSANTS INSTALLATION ÉLECTRIQUE

POS Codice	Q.tà	 Descrizione	 Description	 Designation	 Benennung	 Descripción
1 1591270001	1 NR	fotocellula	photocell	cellule photo-électrique	photozelle	fotocélula
2 159127000101	1 NR	cavo elettrico	electric cable	câble électrique	elektrokabel	cable eléctrico
3 1585570013	1 NR	catarifrangente	reflector	catadioptré	reflektor	catadióptrico
4 1590900003	1 NR	microinterruttore 2 contatti nc testina braccio disassato e rotella in plastica cavo lungo 2 metri	2 nc contacts microswitch head offset arm and wheel plastic long cable 2m	microinterrupteur	mikroschalter	microinterruptor
5 25611500	1 NR	cella di carico	load cell	cellule de charge	messdose	célula de carga
6 1585570005	1 NR	presa elettrica 230v	electrical socket 230v	prise électrique	steckdose	enchufe eléctrico
6 1591700002	1 NR	presa elettrica 110v	electrical socket 110v	prise électrique 110v	steckdose 110v	enchufe eléctrico 110v
7 17194600	1 NR	scatola elettrica versione con pedale	electric box pedal version	boîte électrique	elektrogehäuse	caja eléctrica
7 17194700	1 NR	scatola elettrica versione senza pedale non per macchine jlg	electric box without pedal version no jlg machine	boîte électrique	elektrogehäuse	caja eléctrica





 COMPONENTI IMPIANTO ELETTRICO

 KOMponenten ELEKTROANLAGE

 ELECTRICAL SYSTEM COMPONENTS

 COMPONENTES INSTALACIÓN ELÉCTRICA





 COMPOSANTS INSTALLATION ÉLECTRIQUE

POS Codice	Q.tà	 Descrizione	 Description	 Designation	 Benennung	 Descripción
8 17300400	1 NR	cavo 7 poli II1472 da base a cesto completo di puntalini	7 pole cable II1472-x14j-x390aj base rack with push rods	câble électrique	elektrokabel	cable eléctrico
9 27133100	1 NR	scheda elettronica sensore di carico (scatola in alluminio)	electronic board load sensor (aluminum case)	fiche électrique	elektronische platine	placa electrónica
10 05561800	1 NR	lamiera	plate	tôle	blech	chapa
11 07224400	2 NR	tirante filettato	threaded rod	tirant	turmgestänge	tirante
12 07231500	1 NR	scheda elettronica	electronic board	fiche électrique	elektronische platine	placa electrónica
13 04196900	1 NR	batteria tampone	buffer battery	batterie tampon	pufferbatterie	de amortiguamiento de la batería
13 041969R0	1 NR	batteria secca	dry battery	batterie sans acide	batterie ohne säure	batería sin acido
15 1556350001	1 NR	luce stabilizzatore	stabilizer light	lumière stabilisateur	abstützungsbeleuchtung	luz estabilizador
16 1556350036	1 NR	corpo	body	corps	gehäuse	cuerpo
17 1556350035	1 NR	lampadina	lamp	ampoule	glühbirne	bombilla
18 1556350034	1 NR	spia	pilot light	témoin	kontrollleuchte	indicador luminoso

 COMPONENTI IMPIANTO ELETTRICO

 KOMponenten ELEKTROANLAGE 
 ELECTRICAL SYSTEM COMPONENTS





 COMPONENTES INSTALACIÓN ELÉCTRICA 
 COMPOSANTS INSTALLATION ÉLECTRIQUE

POS Codice	Q.tà	 Descrizione	 Description	 Designation	 Benennung	 Descripción
19 1590900002	1 NR	microinterruttore 2 contatti nc testina braccio e rotella in acciaio cavo lungo 2 metri	2 nc contacts microswitch head arm and wheel steel long cable 2m	microinterruteur	mikroschalter	microinterruptor
20 05953800	1 NR	staffa	bracket	étrier	haltebügel	estribo
21 17048500	1 NR	scatola elettrica	electric box	boîte électrique	elektrogehäuse	caja eléctrica
22 1556350015	1 NR	interuttore automatico magnetotermico 220v	automatic thermal switch 220v	interrupteur	interruptores	interruptor
22 1556350063	1 NR	interuttore automatico magnetotermico 110-120v 25a (fino a c170000355 montato c16 su macchine 120v)	automatic thermal switch 110-120v 25a (until c170000355 mounted c16 on 120v machines)	interrupteur	interruptores	interruptor
23 27031700	1 NR	interuttore a pedale	foot switch	interrupteur	interruptores	interruptor
24 06412400	1 NR	lamiera piegata	folded plate	tôle pliée	blech gebogen	chapa doblada
25 06936400	1 NR	supporto	support	support	halterung	soporte

 COMPONENTI IMPIANTO ELETTRICO

 KOMponenten ELEKTROANLAGE 
 ELECTRICAL SYSTEM COMPONENTS

 COMPONENTES INSTALACIÓN ELÉCTRICA 
 COMPOSANTS INSTALLATION ÉLECTRIQUE

POS Codice	Q.tà	 Descrizione	 Description	 Designation	 Benennung	 Descripción
26 27073800	1 NR	cover prese usa al cesto, receptacle box part n°:1671207	cover take usa to basket, receptacle box part n°:1671207	connecteur	verbinger	conectador
27 27073900	1 NR	plug prese usa al cesto, receptacle part n°:4460346	plug socket to basket usa, receptacle part n°:4460346	connecteur	verbinger	conectador
28 27073700	1 NR	box prese usa al cesto, receptacle part n°:0861731	box take usa to basket, receptacle part n°:0861731	connecteur	verbinger	conectador
29 1556350013	1 NR	spina fissa 230v 90°	plug 230v 90 °	cheville	stif	clavija
29 1556350064	1 NR	spina fissa 110v 90°	plug 110v 90°	cheville	stif	clavija
29 27074000	1 NR	terminal presa usa a terra, conn plug part n°:4460138	terminal ground socket usa, conn plug part n °: 4460138	connecteur	verbinger	conectador
30 17473700	1 NR	slitta per connettore 24 vie	slide for 24-way connector	coulisseau	schlitten	corredera
31 17473600	1 NR	parte di connettore 24vie	connector part 24 way	connecteur	verbinger	conectador





 COMPONENTI IMPIANTO ELETTRICO

KOMPONENTEN ELEKTROANLAGE 

 ELECTRICAL SYSTEM COMPONENTS

COMPONENTES INSTALACIÓN ELÉCTRICA 

 COMPOSANTS INSTALLATION ÉLECTRIQUE

POS Codice	Q.tà	 Descrizione	 Description	 Designation	 Benennung	 Descripción
32 17306300	18 NR	puntalino femmina per connettore 56 vie scheda master d=1.5	ferrule female connector 56 way main board d = 1.5	butée femelle connecteur 56 voies carte master d = 1.5	aufagestift buchse 56-wege-verbinder masterplatine d = 1.5	conector punta hembra 56 vías tarjeta master d=1,5
33 17473800	6 NR	puntalino femmina per connettore 24 vie scheda cella di carico d=2.8	ferrule female connector 24 way board load cell d = 2.8	embout femelle pour connecteur 24 voies carte cellule de charge d=2.8	verschraubung buchse für 24-wege-verbinder korblast-platine d=2,8	puntal hembra para conector 24 vías celula de carga d=2.8

 COMPONENTI IMPIANTO ELETTRICO

KOMPONENTEN ELEKTROANLAGE 

 ELECTRICAL SYSTEM COMPONENTS

COMPONENTES INSTALACIÓN ELÉCTRICA 



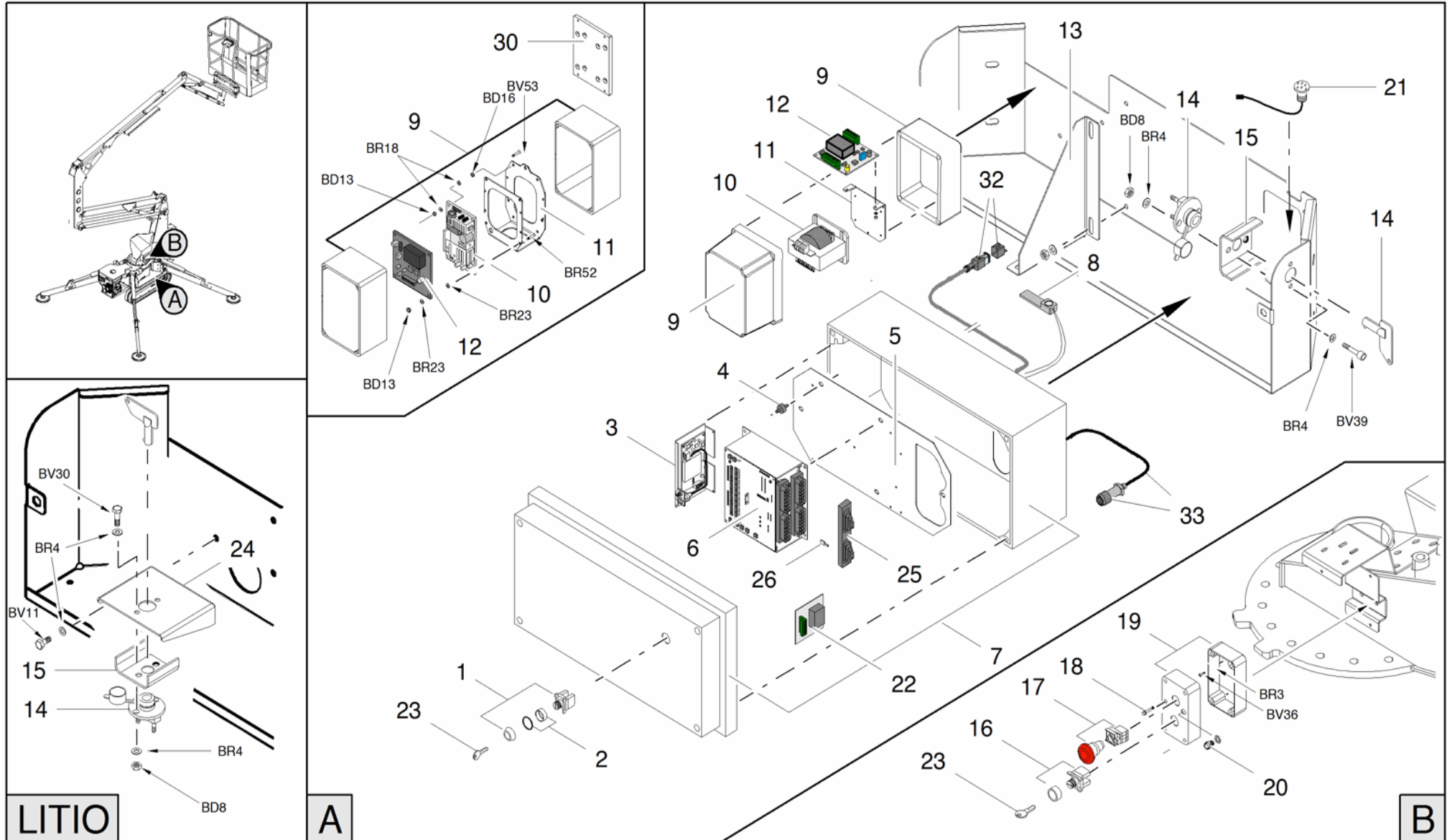

 COMPOSANTS INSTALLATION ÉLECTRIQUE



 COMPONENTI IMPIANTO ELETTRICO

 KOMponenten ELEKTROANLAGE 
 ELECTRICAL SYSTEM COMPONENTS





 COMPONENTES INSTALACIÓN ELÉCTRICA 
 COMPOSANTS INSTALLATION ÉLECTRIQUE

POS Codice	Q.tà	 Descrizione	 Description	 Designation	 Benennung	 Descripción
1 1585570006	1 NR	selettore	selector	sélecteur	wählschalter	selector
2 1602410001	1 NR	adattatore	adapter	adaptateur	adapter	adaptador
3 26608500	1 NR	scheda elettronica	electronic board	fiche électrique	elektronische platine	placa electrónica
4 05971800	4 NR	antivibrante	anti-vibrating	anti - vibrant	vibrationsdämpfer	antivibrante
5 06458600	1 NR	lamiera	plate	tôle	blech	chapa
6 26608200	1 NR	scheda elettronica (+17172600 se fornita a ricambio con software installato)	electronic board (+17172600 if supplied parts with software installed)	fiche électronique	elektronische platine	tarjeta electrónica
6 26907000	1 NR	scheda elettrica versione litio (+17172600 se fornita a ricambio con software installato)	electric board lithium version (+17172600 if supplied parts with software installed)	fiche électrique	elektrische platine	tarjeta eléctrica
7 1556350053	1 NR	scatola elettrica	electric box	boîte électrique	elektrogehäuse	caja eléctrica
8 26608600	1 NR	antenna	antenna	antenne	antenne	antena

 COMPONENTI IMPIANTO ELETTRICO

 KOMponenten ELEKTROANLAGE 
 ELECTRICAL SYSTEM COMPONENTS

 COMPONENTES INSTALACIÓN ELÉCTRICA 
 COMPOSANTS INSTALLATION ÉLECTRIQUE

POS Codice	Q.tà	 Descrizione	 Description	 Designation	 Benennung	 Descripción
9 17047600	1 NR	scatola elettrica	electric box	boîte électrique	elektrogehäuse	caja eléctrica
9 17348200	1 NR	scatola elettrica switching (a partire da c170000340 per macchine ansi)	switching electrical box (from c170000340 for ansi machines)	boîte électrique	elektrogehäuse	caja eléctrica
10 1628400004	1 NR	trasformatore 230v	transformer 230v	transformateur 230v	transformator 230v	transformador 230v
10 26610700	1 NR	trasformatore 110v	transformer 110v	transformateur 110v	transformator 110v	transformador 110v
10 27249800	1 NR	alimentatore switching (da c170000340 per macchine ansi)	switching power supply (from c170000340 for ansi machines)	transformateur	transformator	transformador
11 06543500	1 NR	staffa	bracket	étrier	haltebügel	estribo
11 07243300	1 NR	lamiera supporto scheda e switching (da c170000340 per macchine ansi)	braket for card and switching (from c170000340 for ansi machines)	support	halterung	soporte
12 26608400	1 NR	scheda elettronica	electronic board	fiche électrique	elektronische platine	placa electrónica
12 27268500	1 NR	scheda trasformatore resinata (da c170000340 per macchine ansi)	transformer board resinate (from c170000340 for ansi machines)	fiche électrique	elektronische platine	placa electrónica





 COMPONENTI IMPIANTO ELETTRICO

 KOMponenten ELEKTROANLAGE

 ELECTRICAL SYSTEM COMPONENTS

 COMPONENTES INSTALACIÓN ELÉCTRICA

 COMPOSANTS INSTALLATION ÉLECTRIQUE

POS Codice	Q.tà	 Descrizione	 Description	 Designation	 Benennung	 Descripción
13 06895800	1 NR	rinforzo	reinforcement	renforcement	satzverstärkung	refuerzo
14 04774900	1 NR	stacca batteria	battery cut-off device	coupe batterie	batterietrennschalter	corta-batería
15 05568700	1 NR	supporto	support	support	halterung	soporte
16 1651290001	1 NR	selettore 3 posizioni per chiave	3 position selector switch for key	sélecteur	wählschalter	selector
17 1591270004	1 NR	pulsante	button	bouton	druckknopf	botón
18 1628400002	1 NR	spia	pilot light	témoin	kontrollleuchte	indicador luminoso
19 17044100	1 NR	scatola elettrica versione motore termico	electric box thermic engine version	boîte électrique	elektrogehäuse	caja eléctrica
19 17044600	1 NR	scatola elettrica versione litio	electric box lithium version	boîte électrique	elektrogehäuse	caja eléctrica
20 1628400001	1 NR	pulsante	button	bouton	druckknopf	botón
21 06639100	1 NR	avvisatore acustico	acoustic alarm	détecteur acoustique	akustischer melder	sirena
22 1651290014	1 NR	scheda	board	fiche	platine	placa
23 1651290015	1 NR	chiave	key	clés	schlüssel	clave
24 06922600	1 NR	supporto	support	support	halterung	soporte





 COMPONENTI IMPIANTO ELETTRICO

 KOMponentEN ELEKTROANLAGE

 ELECTRICAL SYSTEM COMPONENTS

 COMPONENTES INSTALACIÓN ELÉCTRICA

 COMPOSANTS INSTALLATION ÉLECTRIQUE

POS Codice	Q.tà	 Descrizione	 Description	 Designation	 Benennung	 Descripción
25 17306000	2 NR	parte di connettore	connector part	connecteur	verbinger	conectador
25 17306100	2 NR	coperchio	cover	couvercle	deckel	tapa
25 17306200	2 NR	slitta	slide	coulisseau	schlitten	corredera
26 17306300	1 NR	puntalino femmina per connettore 56 vie scheda master d=1.5	ferrule female connector 56 way main board d = 1.5	butée femelle connecteur 56 voies carte master d = 1.5	auflagestift buchse 56-wege-verbinder masterplatine d = 1.5	conector punta hembra 56 vías tarjeta master d=1,5
30 07347900	1 NR	piastra adattamento	plate adapter	reglage de la plaque	fussplattenverstellu ng	ajuste de la placa
31 17506700	1 NR	kit banco programmazione schede piattaforme	programmation kit	kit programmation	programmationsatz	kit programacion
32 17639300	1 NR	kit aggiunta connettore e tappo per telematics jlg standard machines	plug connector kit for telematics jlg standard machines			
33 17626900	1 NR	cavo telecomando a terra 3s completo di connettore e tappo	cable remote ground 3s complete with plug connector	câble électrique	elektrokabel	cable eléctrico

 COMPONENTI IMPIANTO ELETTRICO LITIO

 ELECTRICAL SYSTEM COMPONENTS LITHIUM

 COMPOSANTS INSTALLATION ÉLECTRIQUE LITHIUM

KOMPONENTEN ELEKTROANLAGE LITHIUM 



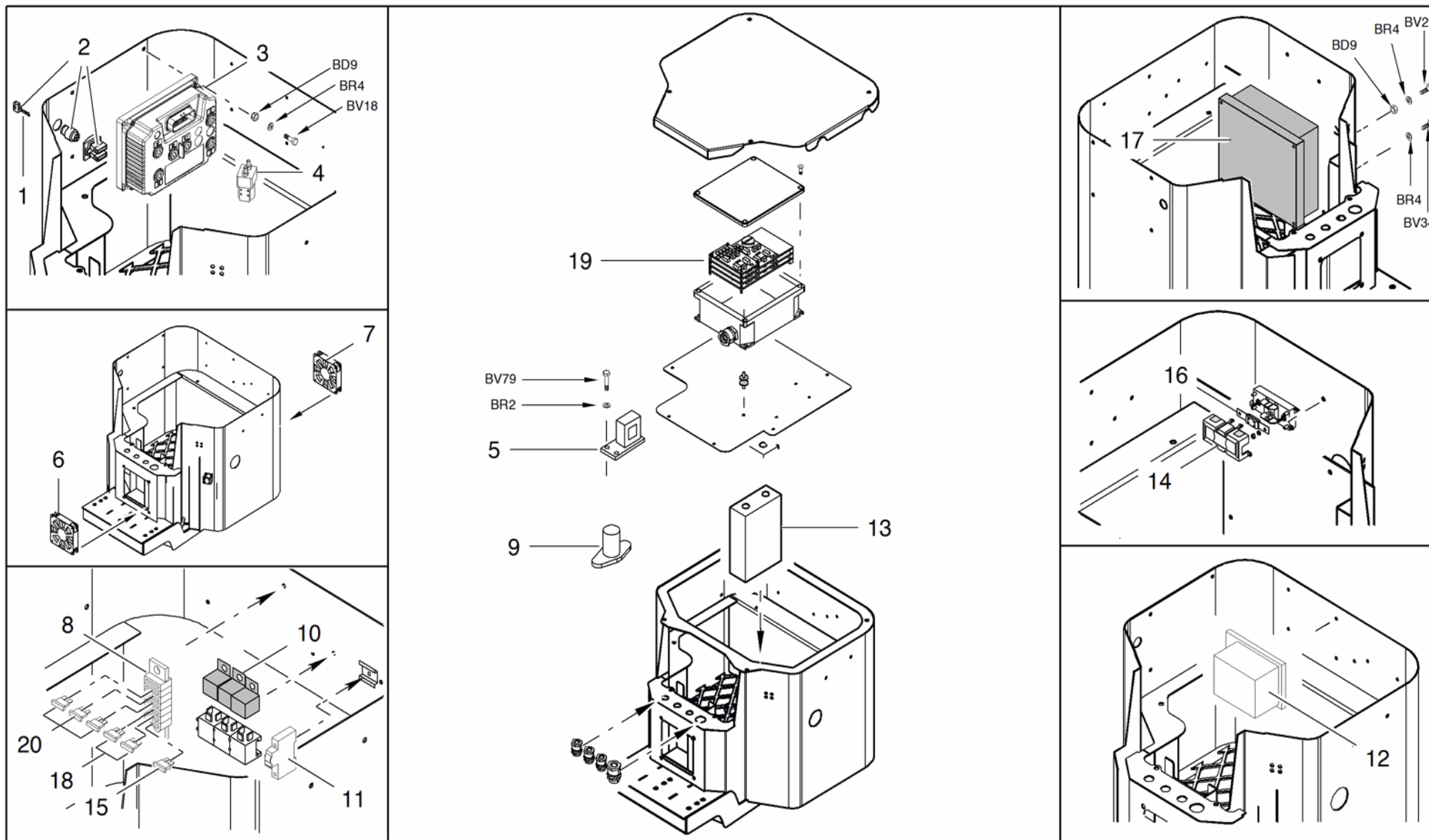

COMPONENTES INSTALACIÓN ELÉCTRICA LITHIUM 



 COMPONENTI IMPIANTO ELETTRICO LITIO

 KOMponenten ELEKTROANLAGE LITHIUM 
 ELECTRICAL SYSTEM COMPONENTS LITHIUM





 COMPONENTES INSTALACIÓN ELÉCTRICA LITHIUM 
 COMPOSANTS INSTALLATION ÉLECTRIQUE LITHIUM

POS Codice	Q.tà	 Descrizione	 Description	 Designation	 Benennung	 Descripción
1 1692150002	1 NR	chiave accensione	ignition key	clef de démarrage	zündschlüssel	clave de encendido
2 1692150001	1 NR	blocchetto	block	bloc	block	bloque
3 26774600	1 NR	inverter	inverter	inverter	inverter	inverter
4 26429300	1 NR	teleruttore	remote-control switch	télérupteur	fernshalter	teleruptor
5 1690690021	1 NR	sensore lem (fino a matricola c170000329)	sensor lem (until serial c170000329)	capteur	sensor	sensor
5 1735210002	1 NR	trasduttore di corrente (da c170000330)	current transducer (from c170000330)	transformateur d'intensité (da c170000330)	strommessumformer (da c170000330)	transductor de corriente eléctrica (da c170000330)
6 1690690001	1 NR	ventola anteriore	front fan	ventilateur	lüfterrad	ventilador
7 1690690002	1 NR	ventola posteriore	rear fan	ventilateur	lüfterrad	ventilador
8 1690690003	1 NR	blocchetto	fuse holders block	bloc	block	bloque
9 1690690020	1 NR	teleruttore	remote-control switch	télérupteur	fernshalter	teleruptor
10 1690690005	1 NR	relè	relay	relais	relais	relé
11 1690690006	1 NR	temporizzatore	timer	minuteur	timer	temporizador
12 27032500	1 NR	trasformatore	transformer	transformateur	transformator	transformador

 COMPONENTI IMPIANTO ELETTRICO LITIO

 KOMponenten ELEKTROANLAGE LITHIUM 
 ELECTRICAL SYSTEM COMPONENTS LITHIUM

 COMPONENTES INSTALACIÓN ELÉCTRICA LITHIUM 
 COMPOSANTS INSTALLATION ÉLECTRIQUE LITHIUM

POS Codice	Q.tà	 Descrizione	 Description	 Designation	 Benennung	 Descripción
13 1690690022	1 NR	cella singola versione a	single cell version a	cellule unique a	einzelzelle a	unicelulares a
13 1742410001	1 NR	cella litio versione b	cell lithium version b	cellule unique b	einzelzelle b	unicelulares b
14 1690690009	1 NR	coperchio	cover	couvercle	deckel	tapa
15 05760800	1 NR	fusibile 7,5 a	fuse 7,5 a	fusible 7,5 a	sicherungsdraht 7,5 a	fusible 7,5 a
16 1690690011	1 NR	fusibile 160a	fuse 160a	fusible 160a	sicherungsdraht 160a	fusible 160a
17 27193200	1 NR	carica batteria 230v	battery charger 230v	charge batterie 230v	batterielader 230v	carga baterías 230v
17 27193300	1 NR	carica batteria 110-120v	battery charger 110-120v	charge batterie 110-120v	batterielader 110-120v	carga baterías 110-120v
18 05760600	1 NR	fusibile 3a	fuse 3a	fusible 3a	sicherungsdraht 3a	fusible 3a
19 1690690013	1 NR	bms 48v (fino a matricola c170000329)	bms 48v (until serial c170000351)	bms 48v	bms 48v	bms 48v
19 1735210001	1 NR	bms 48v nuova versione (da c170000330)	bms 48v new version (from c170000330)	bms 48v	bms 48v	bms 48v
20 05760900	1 NR	fusibile 10a	fuse 10a	fusible 10a	sicherungsdraht 10a	fusible 10a

 TELECOMANDO

FERNSTEUERUNG 

 REMOTE CONTROL

TELECOMANDO 



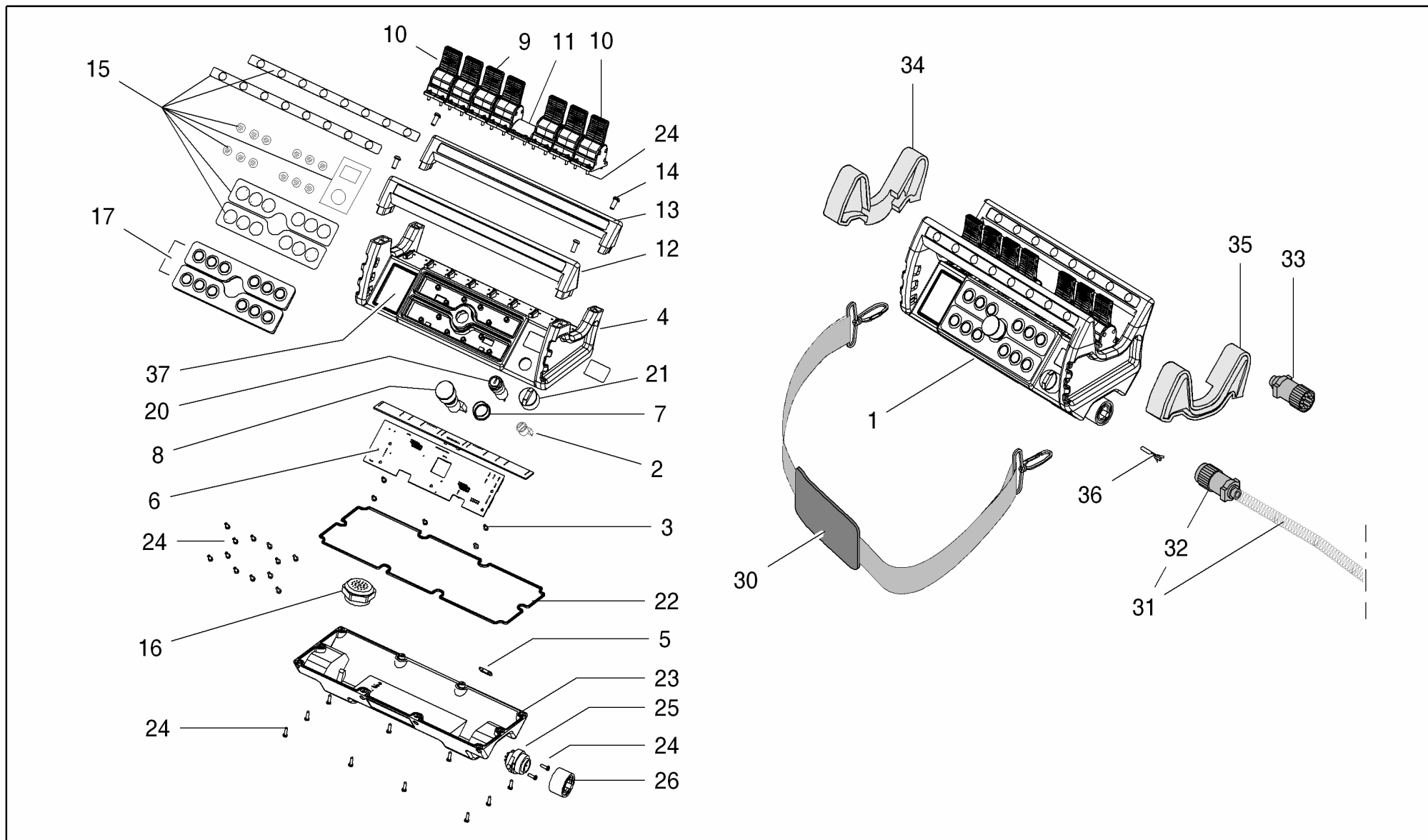

 TÉLÉCOMMANDE



 TELECOMANDO

 FERNSTEUERUNG 
 REMOTE CONTROL





 TELECOMANDO 
 TÉLÉCOMMANDE

POS Codice	Q.tà	 Descrizione	 Description	 Designation	 Benennung	 Descripcìon
1 26839300	1 NR	telecomando	remote control	télécommande	fernsteuerung	telecomando
2 07359400	1 NR	contatto per stop emergenza telecomando 3s	contact for remote emergency stop 3s	contacter pour remote 3s arret d'urgence	kontakt für remote not 3s	contacto para remotos 3s parada de emergencia
3 2646170003	5 NR	viti scheda elettronica	attachment screw electronic board	vis	schraube	tornillo
4 2646170004	1 NR	coperchio superiore blu telecomando (per ricambio è necessario il sn del telecomando)	upper cover blue remote control (as spare is compulsory the sn of remote control)	couvercle	deckel	tapa
4 2683950001	1 NR	coperchio superiore telecomando case blu solo coperchio, senza componenti e senza display	top cover remote control case blue only case, without components and display	couvercle	deckel	tapa
5 07359500	1 NR	contatto reed interno telecomando 3s	reed contact internal remote 3s	reed contact intérieur 3s distance	reedkontakt indoor remote 3s	contacto reed 3s remoto de interior
6 2646170002	1 NR	scheda elettronica per telecomando	electronic board for remote control	fiche électrique	elektronische platine	placa electrónica
7 2646170007	1 NR	anello	ring	bague	ring	anillo

 TELECOMANDO

 FERNSTEUERUNG 
 REMOTE CONTROL





 TELECOMANDO 
 TÉLÉCOMMANDE

POS Codice	Q.tà	 Descrizione	 Description	 Designation	 Benennung	 Descripción
8 2646170008	1 NR	pulsante emergenza	emergency button	bouton d'urgence	notstand knopf	pulsador de emergencia
9 17550700	1 NR	kit protezione in gomma per joystick nera	black rubber cover kit for joystick			
9 2646170009	5 NR	leva nera	lever black	levier	hebel	palanca
10 17550800	1 NR	kit protezione in gomma per joystick rossa	red rubber cover kit for joystick			
10 2646170010	2 NR	leva rossa	lever red	levier	hebel	palanca
11 2646170011	1 NR	coperchio	cover	couvercle	deckel	tapa
12 2646170013	1 NR	impugnatura inferiore	grip lower part	poignée	griff	empuñadura
13 2646170012	1 NR	impugnatura superiore	grip upper part	poignée	griff	empuñadura
14 2646170014	4 NR	vite	screw	vis	schraube	tornillo
15 16978100	1 NR	kit adesivi	decals kit	kit collants	aufklebersatz	kit pegatinas
16 2646170027	1 NR	cicalino completo di scheda elettronica telecomando	beeper for remote control	vibreur sonore complet de la carte électronique de la télécommande	hupe für fernsteuerung	zumbador completo de tarjeta electrónica telemando
17 2646170017	1 NR	pulsanti	buttons	boutons	druckknopf	botones

 TELECOMANDO

 FERNSTEUERUNG 
 REMOTE CONTROL





 TELECOMANDO 
 TÉLÉCOMMANDE

POS Codice	Q.tà	 Descrizione	 Description	 Designation	 Benennung	 Descripción
20 2683930001	1 NR	interruttore	switch	interrupteur	interruptores	interruptor
21 2683930002	1 NR	chiave accensione	ignition key	clef de démarrage	zündschlüssel	clave de encendido
22 2646170022	1 NR	guarnizione	gasket	joint	dichtung	guarnición
23 2646170023	1 NR	coperchio inferiore	cover lower part	couvercle	deckel	tapa
24 2646170024	56 NR	vite	screw	vis	schraube	tornillo
25 2646170025	1 NR	connettore	connector	connecteur	verbinger	conectador
26 2646170026	1 NR	coperchio connettore	cover connector	couvercle	deckel	tapa
30 2646170030	1 NR	cinghia	belt	courroie	riemen	correa
31 17235800	1 NR	cavo telecomando completo iiis /200	complete remote control cable iiis /200	câble complet télécommande iiis /200	fernbedienungskab el komplett iiis /200	cable telecomando completo iiis /200
32 2646170032	1 NR	connettore collegamento telecomando	connector for remote control	connecteur	verbinger	conectador
33 1684540001	1 NR	dispositivo di comando per abilitazione emergenza a terra	control device for activating the emergency ground	dispositif de commande pour activer le terrain en cas d'urgence	steuervorrichtung für die not-boden	dispositivo de control para activar la planta de emergencia
34 07027200	1 NR	protezione sinistra	left protection	protection gauche	abdeckung links	protección izquierda

 TELECOMANDO

 FERNSTEUERUNG 
 REMOTE CONTROL

 TELECOMANDO 
 TÉLÉCOMMANDE

POS Codice	Q.tà	 Descrizione	 Description	 Designation	 Benennung	 Descripción
35 07027100	1 NR	protezione destra	right protection	protection droits	abdeckung rechts	protección derecha
36 27283000	1 NR	puntalino femmina per connettore telecomando	terminal female connector for remote control	connecteur femelle d'orteil pour la télécommande	toe-buchse für die fernbedienung	conector hembra del dedo del pie para el control remoto
36 2728300001	1 NR	puntalino maschio per connettore telecomando	terminal male connector for remote control	virole connecteur mâle pour la télécommande	zwingstecker für fernbedienung	férula de conector macho para el control remoto
37 07320200	1 NR	schermo lcd (per ricambio è necessario il sn del telecomando)	display (as spare is compulsory the sn of remote control)	afficher	anzeige	pantalla

AGGIORNATO IL / UPDATED 14/01/2015

Cod. 17063500 (no a ricambio/no spare kit)

KIT ADESIVI PIATTAFORMA AEREA /
AERIAL PLATFORM KIT STICKERS
JLG - X14J

+ kit in lingua non inclusi nel codice generale e non gestiti a ricambio
+ language code not included in the standard kit and no spare kit

- + 170635IT
- +170635GB
- +170635FR
- +170635DE
- + 170635ES
- + 170635NL
- + 170635PT
- +170635SW
- + 170635DA
- + 170635NO

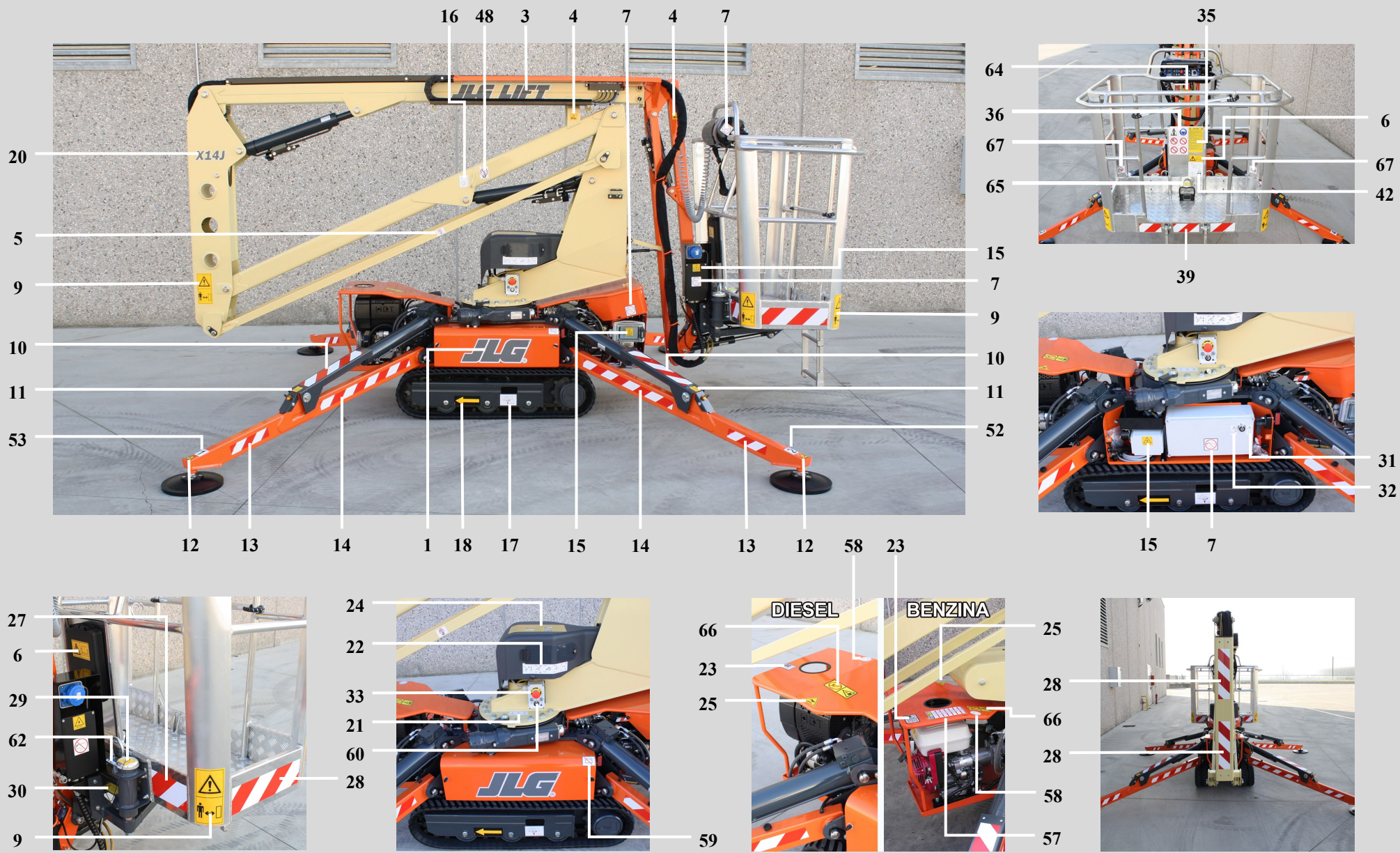

KIT ADESIVI - X14J

SET OF DECALS - X14J

KIT COLLANTS - X14J

AUFKLEBERSATZ - X14J

KIT ADHESIVOS - X14J

ADHESIEKIT - X14J

Cod. 17063500

Ed. 14/01/2015

Tav 01



KIT ADESIVI - X14J

SET OF DECALS - X14J

KIT COLLANTS - X14J

AUFKLEBERSATZ - X14J

KIT ADHESIVOS - X14J

ADHESIEKIT - X14J

Cod. 17063500

Ed. 14/01/2015

Tav 02

Cod. 17063500 *(no a ricambio/no spare kit)*

KIT ADESIVI PIATTAFORMA AEREA /

AERIAL PLATFORM KIT STICKERS

JLG - X14J

17063500 POSIZIONE ADESIVI / POSITION STICKERS

IN LINGUA / LANGUAGE

JLG

Aggiornato il / Updated 14/01/2015

VOLTAGGIO / VOLTAGE

POSIZIONE	CODICE	REV.	DESCRIZIONE	QUANTITA'
1	07060500	A	ADESIVO LOGO JLG L=432x150MM	02
2				
3	07060600	A	ADESIVO LOGO JLG LIFT L=624x100 MM	02
4	06041300		ADESIVO ATTENZIONE PERICOLO TAGLI L=45 X 40 GIALLO	04
5	07056700	A	ADESIVO JLG DIVIETO DI SOLLEVAMENTO L=54,88X40	02
6	06040900		ADESIVO LEGGERE IL MANUALE L=125 X 65 GIALLO	02
7	1001125483	A	ADESIVO JLG VIETATO LAVARE L=63,5X63,5 MM	06
8	06041800	B	ADESIVO RUMORE 97 Db L=90 X 100	01
8	07034200	B	ADESIVO RUMORE 104 dB L=90X100	01
9	06040300	A	ADESIVO PERICOLO MANTENERE LE DISTANZE GIALLO L=100 X 200	06
10	06039900	A	ADESIVO CON RIGHE BIANCHE ROSSE L= 420 X 80	04
11	1608500004	A	ADESIVO PRESSIONE PIEDINO LL14.72 R.max= daN=1200 L=45x50	04
12	06041200	A	ADESIVO SCHIACCIAMENTO PIEDI TRIANGOLARE L=53X46 GIALLO	04
13	06040100	A	ADESIVO CON RIGHE BIANCHE ROSSE L= 240 X 50	08
14	06039600	A	ADESIVO CON RIGHE BIANCHE ROSSE L= 700 X 50	08
15				
16	1703814	A	ADESIVO JLG ATTACCO ANCORAGGIO L=55,56X76,2 MM	02
17	1608500005	A	ADESIVO PRESSIONE CARRO AL SUOLO LL1472 F=1400 daN L=100x69	02
18	06040500	A	ADESIVO DIREZ. TRASLAZIONE FRECCIA GIALLA SFONDO NERO L=61 X 160	02
19				
20	07061000	A	ADESIVO JLG LOGO PIATTAFORMA AEREA CINGOLATA X14J L=200X64,5 MM	02
21	06941900	A	ADESIVO SELETTORE A CHIAVE 2° TELECOMANDO LL14.72 IIIS L=101X44	01
22	1608500018	B	ADESIVO COMANDI LEVE DISTRIBUTORE PARTE AEREA LL1472 L=234X51	01
23	1701542	A	ADESIVO JLG CARBURANTE BENZINA L= 101X63,5	01

17063500 POSIZIONE ADESIVI / POSITION STICKERS**IN LINGUA / LANGUAGE****JLG**

Aggiornato il / Updated 14/01/2015

VOLTAGGIO / VOLTAGE

POSIZIONE	CODICE	REV.	DESCRIZIONE	QUANTITA'
23	1701505	A	ADESIVO JLG CARBURANTE DIESEL L= 50,8X63,5	01
24				
25	06056300	A	ADESIVO PERICOLO SCOTTATURE L=60X51 TRIANGOLARE SFONDO GIALLO	01
26				
27	06040000	A	ADESIVO CON RIGHE BIANCHE ROSSE L= 190 X 100	02
28	06086700	A	ADESIVO CON RIGHE BIANCHE E ROSSE L=430X100	04
29				
30				
31	06086000	A	ADESIVO SISTEMA BYPASS TRASLAZIONE L=30X50	01
32	06085900	A	ADESIVO SISTEMA BYPASS PARTE AEREA L=30X50	01
33	1706898	A	ADESIVO JLG EMERGENCY STOP Ø EST.57,15 Ø INT. 30,58	01
34				
35				
36	06924300	A	ADESIVO CASCO - IMBRAGATURA - DIVIETI SERIE METAL-IIIS L=170X250 MM	01
37	06044000	A	ADESIVO ATTACCO SOLLEVAMENTO SFONDO BIANCO COLORE BLU Ø40	04
38				
39	06039700	A	ADESIVO CON RIGHE BIANCHE ROSSE L= 700 X 80	01
40				
41	06040200	A	ADESIVO POMPA MANUALE PIATTAFORME L= 86X34	01
42	07059400	A	ADESIVO JLG - X14J PORTATA CESTO 2 PERSONE L=135X145 MM	01
43				
44	1701504	A	ADESIVO JLG OLIO IDRAULICO L=50,8x63,5 MM	01
45	06165000	A	ADESIVO LIVELLO OLIO IDRAULICO Ø50 SFONDO BIANCO	01
46				

17063500 POSIZIONE ADESIVI / POSITION STICKERS**IN LINGUA / LANGUAGE****JLG**

Aggiornato il / Updated 14/01/2015

VOLTAGGIO / VOLTAGE

POSIZIONE	CODICE	REV.	DESCRIZIONE	QUANTITA'
47	1608500016	A	ADESIVO MANTENERE 1 METRO DI DISTANZA LL1472 L=75X35	01
48	1701499	A	ADESIVO JLG DIVIETO DI SOLLEVAMENTO L= 55,56X76 MM	02
49				
50	06555700	A	ADESIVO N° 3 L=50X60 BIANCO	01
51	06555800	A	ADESIVO N° 4 L=50X60 BIANCO	01
52	06555600	A	ADESIVO NR 2 L=50X60 BIANCO	01
53	06555500	A	ADESIVO NR 1 L=50X60 BIANCO	01
54	1608500011	B	ADESIVO COMANDI DISTRIBUTORE PARTE CARRO SX LL1472 L=180X50	01
55	1608500012	B	ADESIVO COMANDI DISTRIBUTORE PARTE CARRO DX LL1472 L=180X50	01
56				
57	06232100	A	ADESIVO "ATTENZIONE BENZINA INFIAMMABILE" 7 LINGUE L=90X171	01
58	06060000	A	ADESIVO LIVELLO OLIO MOTORE Ø50mm	01
59	1702155	A	ADESIVO JLG STACCABATTERIA L= 63,5X50,80 MM	01
60	06919400	A	ADESIVO AVVIAMENTO MOTORE DA TERRA IIIS L=72X35	01
61				
62	1704277	A	ADESIVO JLG ATTACCO CINTURE DI SICUREZZA L= 76,2X19,05 MM	02
63				
64	1706493	B	ADESIVO JLG SCORRIMENTO SBARRA CHIUSURA CESTO L= 76,2X25,4 MM	01
65	1705828	B	ADESIVO JLG INTERUTTORE PEDALE L= 69,85X54	01
66	1706098	B	ADESIVO JLG PERICOLO ESPLOSIONE L=63,5X117,475 MM	01
67	07050700	A	ADESIVO JLG DIVIETO ATTACCO CINTURE DI SICUREZZA L=76,2X19,5	02
68	07071000	B	ADESIVO JLG CLAXON SU PIATTAFORME L=38,3X28,55	01
42	07059300	A	ADESIVO JLG - X14J PORTATA CESTO 1 PERSONA L=135X145 MM - non in distinta	01

KIT ADESIVI IN LINGUA /
LANGUAGE KIT STICKERS

JLG - X14J

Cod. (no a ricambio/no spare kit)

170635IT

170635GB

170635FR

170635DE

170635ES

170635NL

170635PT

170635SW

170635DA

170635NO

170635 ADESIVI IN LINGUA / ADHESIVES IN LANGUAGE****IN LINGUA / LANGUAGE****JLG****Aggiornato il / Updated 14/01/2015****VOLTAGGIO / VOLTAGE**

POSIZIONE	CODICE	REV.	DESCRIZIONE	QUANTITA'
	170635IT		ADESIVI PIATTAFORMA AEREA CINGOLATA JLG-X14J - LINGUA ITALIANO	
15	06561200	A	ADESIVO PERICOLO 230 VOLT GIALLO L=47 X 47	04
24	07203200	A	ADESIVO DISCESA DI EMERG. SERIE LL 3S - X14J X19J X23J - ITA L=280X195 MM	01
29	06448200	A	ADESIVO "SBLOCCARE SOLO NEI CASI PREVISTI" L= 50X50 ITALIANO	02
30	06448100	A	ADESIVO "RIPRISTINARE I TAPPI FERMO GUIDA " ITALIANO L= 90X45	02
35	06555300	B	ADESIVO USO PIATTAFORMA CINGOLATA L=128X230 ITALIANO 01-09-2008	01
	170635GB		ADESIVI PIATTAFORMA AEREA CINGOLATA JLG-X14J - LINGUA INGLESE	
15	06042400	A	ADESIVO PERICOLO 110 VOLT L=47 X 47 GIALLO	04
15	06561200	A	ADESIVO PERICOLO 230 VOLT GIALLO L=47 X 47	04
24	07206200	A	ADESIVO DISCESA DI EMERG. SERIE LL 3S - X14J X19J X23J - ING L=280X195 MM	01
29	06462700	A	ADESIVO "SBLOCCARE SOLO NEI CASI PREVISTI" INGLESE L= 50X50	02
30	06462100	A	ADESIVO "RIPRISTINARE I TAPPI FERMO GUIDA" INGLESE L= 90X45	02
35	06562600	B	ADESIVO USO PIATTAFORMA INGLESE L=128X230	01
	170635FR		ADESIVI PIATTAFORMA AEREA CINGOLATA JLG-X14J - LINGUA FRANCESE	
15	06561200	A	ADESIVO PERICOLO 230 VOLT GIALLO L=47 X 47	04
24	07206300	A	ADESIVO DISCESA DI EMERG. SERIE LL 3S - X14J X19J X23J - FRA L=280X195 MM	01
29	06462800	A	ADESIVO "SBLOCCARE SOLO NEI CASI PREVISTI" FRANCESE L= 50X50	02
30	06462200	A	ADESIVO "RIPRISTINARE I TAPPI FERMO GUIDA" FRANCESE L= 90X45	02
35	06562700	B	ADESIVO USO PIATTAFORMA FRANCESE L=128X230	01

170635 ADESIVI IN LINGUA / ADHESIVES IN LANGUAGE****IN LINGUA / LANGUAGE****JLG****Aggiornato il / Updated 14/01/2015****VOLTAGGIO / VOLTAGE**

POSIZIONE	CODICE	REV.	DESCRIZIONE	QUANTITA'
	170635DE		ADESIVI PIATTAFORMA AEREA CINGOLATA JLG-X14J - LINGUA TEDESCO	
15	06561200	A	ADESIVO PERICOLO 230 VOLT GIALLO L=47 X 47	04
24	07206400	A	ADESIVO DISCESA DI EMERG. SERIE LL 3S - X14J X19J X23J - TED L=280X195 MM	01
29	06462900	A	ADESIVO "SBLOCCARE SOLO NEI CASI PREVISTI " TEDESCO L= 50X50	02
30	06462300	A	ADESIVO "RIPRISTINARE I TAPPI FERMO GUIDA" TEDESCO L= 90X45	02
35	06562800	B	ADESIVO USO PIATTAFORMA TEDESCO L=128X230	01
	170635ES		ADESIVI PIATTAFORMA AEREA CINGOLATA JLG-X14J - LINGUA SPAGNOLO	
15	06561200	A	ADESIVO PERICOLO 230 VOLT GIALLO L=47 X 47	04
24	07206500	A	ADESIVO DISCESA DI EMERG. SERIE LL 3S - X14J X19J X23J - SPA L=280X195 MM	01
29	06463000	A	ADESIVO "SBLOCCARE SOLO NEI CASI PREVISTI" SPAGNOLO L= 50X50	02
30	06462400	A	ADESIVO "RIPRISTINARE I TAPPI FERMO GUIDA" SPAGNOLO L= 90X45	02
35	06562900	B	ADESIVO USO PIATTAFORMA SPAGNOLO L=128X230	01
	170635NL		ADESIVI PIATTAFORMA AEREA CINGOLATA JLG-X14J - LINGUA OLANDESE	
15	06561200	A	ADESIVO PERICOLO 230 VOLT GIALLO L=47 X 47	04
24	07206600	A	ADESIVO DISCESA DI EMERG. SERIE LL 3S - X14J X19J X23J - OLA L=280X195 MM	01
29	06463100	A	ADESIVO "SBLOCCARE SOLO NEI CASI PREVISTI" OLANDESE L= 50X50	02
30	06462500	A	ADESIVO "RIPRISTINARE I TAPPI FERMO GUIDE" OLANDESE L= 90X45	02
35	06563000	B	ADESIVO USO PIATTAFORMA OLANDESE L=128X230	01
	170635PT		ADESIVI PIATTAFORMA AEREA CINGOLATA JLG-X14J - LINGUA PORTOGHESE	
15	06561200	A	ADESIVO PERICOLO 230 VOLT GIALLO L=47 X 47	04
24	07206700	A	ADESIVO DISCESA DI EMERG. SERIE LL 3S - X14J X19J X23J - POR L=280X195 MM	01
29	06463200	A	ADESIVO "SBLOCCARE SOLO NEI CASI PREVISTI" PORTOGHESE L= 50X50	02
30	06462600	A	ADESIVO "RIPRISTINARE I TAPPI FERMO GUIDA" PORTOGHESE L= 90X45	02
35	06563100	B	ADESIVO USO PIATTAFORMA PORTOGHESE L=128X230	01

170635 ADESIVI IN LINGUA / ADHESIVES IN LANGUAGE****IN LINGUA / LANGUAGE****JLG**

Aggiornato il / Updated 14/01/2015

VOLTAGGIO / VOLTAGE

POSIZIONE	CODICE	REV.	DESCRIZIONE	QUANTITA'
	170635SW		ADESIVI PIATTAFORMA AEREA CINGOLATA JLG-X14J - LINGUA SVEDESE	
15	06561200	A	ADESIVO PERICOLO 230 VOLT GIALLO L=47 X 47	04
24	07206900	A	ADESIVO DISCESA DI EMERG. SERIE LL 3S - X14J X19J X23J - SVE L=280X195 MM	01
29	07137500	A	ADESIVO " SBLOCCARE SOLO NEI CASI PREVIST I " SVEDESE " L= 50X50 MM	02
30	07137400	A	ADESIVO "RIPRISTINARE I TAPPI FERMO GUIDA" SVEDESE L= 90X45 MM	02
35	07137300	B	ADESIVO USO PIATTAFORMA LINGUA SVEDESE L= 128X230 MM	01
	170635DA		ADESIVI PIATTAFORMA AEREA CINGOLATA JLG-X14J - LINGUA DANESE	
15	06561200	A	ADESIVO PERICOLO 230 VOLT GIALLO L=47 X 47	04
24	07206800	B	ADESIVO DISCESA DI EMERG. SERIE LL 3S - X14J X19J X23J - DAN L=280X195 MM	01
29	07138000	A	ADESIVO " SBLOCCARE SOLO NEI CASI PREVIST I " DANESE L= 50X50 MM	02
30	07137900	A	ADESIVO "RIPRISTINARE I TAPPI FERMO GUIDA" DANESE L= 90X45 MM	02
35	07138100	B	ADESIVO USO PIATTAFORMA LINGUA DANESE L= 128X230 MM	01
	170635NO		ADESIVI PIATTAFORMA AEREA CINGOLATA JLG-X14J - LINGUA NORVEGESE	
15	06561200	A	ADESIVO PERICOLO 230 VOLT GIALLO L=47 X 47	04
24	07207000	A	ADESIVO DISCESA DI EMERG. SERIE LL 3S - X14J X19J X23J - NOR L=280X195 MM	01
29	07161800	A	ADESIVO " SBLOCCARE SOLO NEI CASI PREVIST I " NORVESESE " L= 50X50 MM	02
30	07161900	A	ADESIVO "RIPRISTINARE I TAPPI FERMO GUIDA" NORVEGESE L= 90X45 MM	02
35	07162000	B	ADESIVO USO PIATTAFORMA LINGUA NORVESESE L= 128X230 MM	01

AGGIORNATO IL / UPDATED 04/06/2013

Cod. 17065200 (no a ricambio/no spare kit)

KIT ADESIVI PIATTAFORMA AEREA /
AERIAL PLATFORM KIT STICKERS
JLG - X390AJ

+ **Kit in lingua non inclusi nel codice generale e non gestiti a ricambio**

+ ***language code not included in the standard kit and no spare kit***

+ **170652GB**

+ **170652FR**

+ **170652ES**

+ **170652PT**

DA USARE CON / FOR USE WITH

- **17107300 KIT ADESIVI INTEGR. PER PIATT. JLG-ANSI LITHIUM_X390AJ_X500AJ_X550AJ_X700AJ**
- **171073** KIT IN LINGUA**

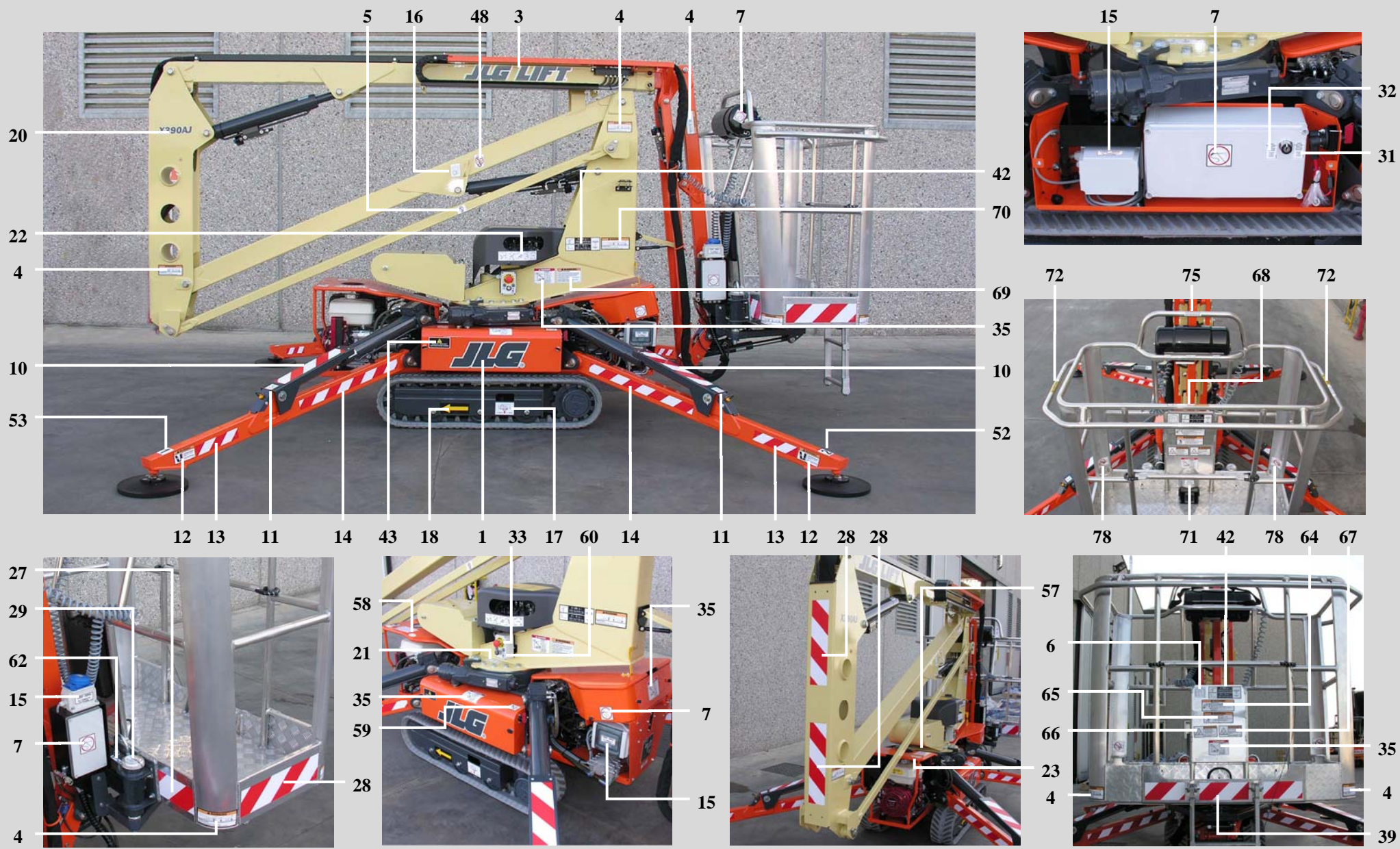

KIT ADESIVI - X390AJ

SET OF DECALS - X390AJ

KIT COLLANTS - X390AJ

AUFKLEBERSATZ - X390AJ

KIT ADHESIVOS - X390AJ

ADHESIEKIT - X390AJ

Cod. 17065200

Ed. 04/06/2013

Tav 01

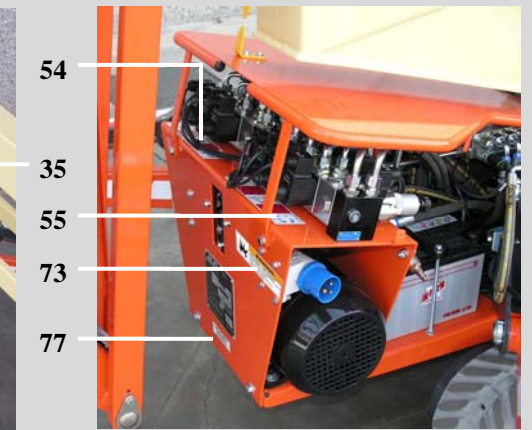
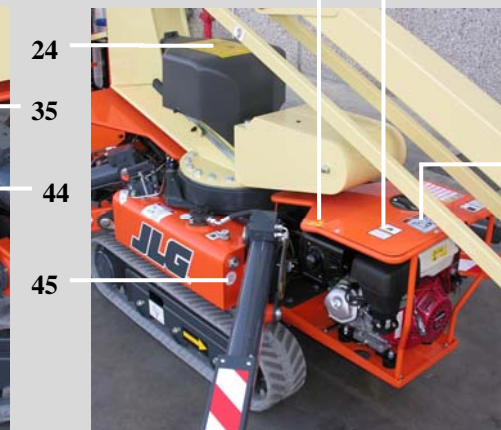
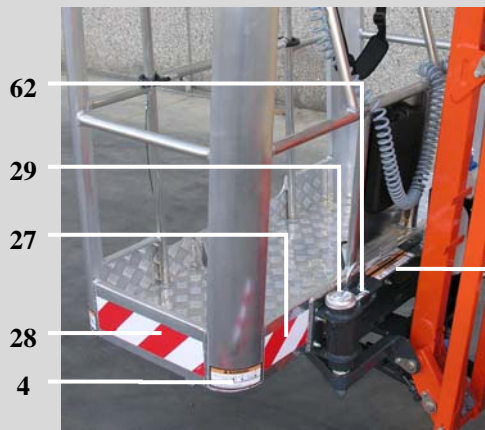
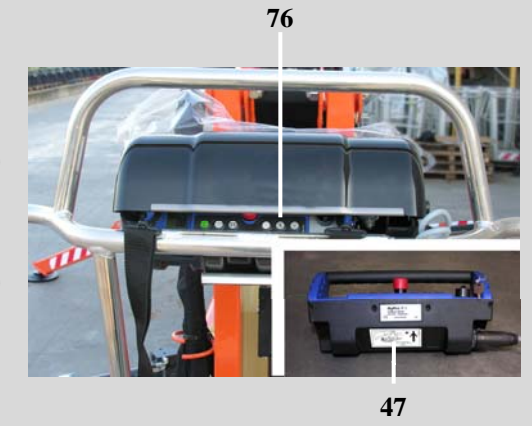
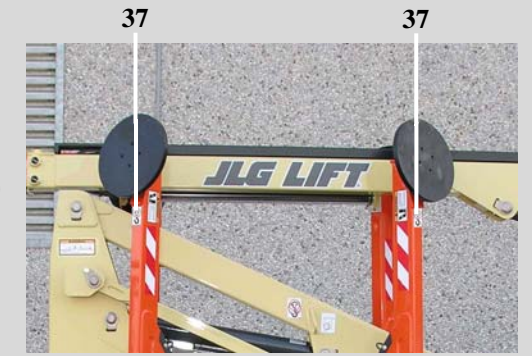
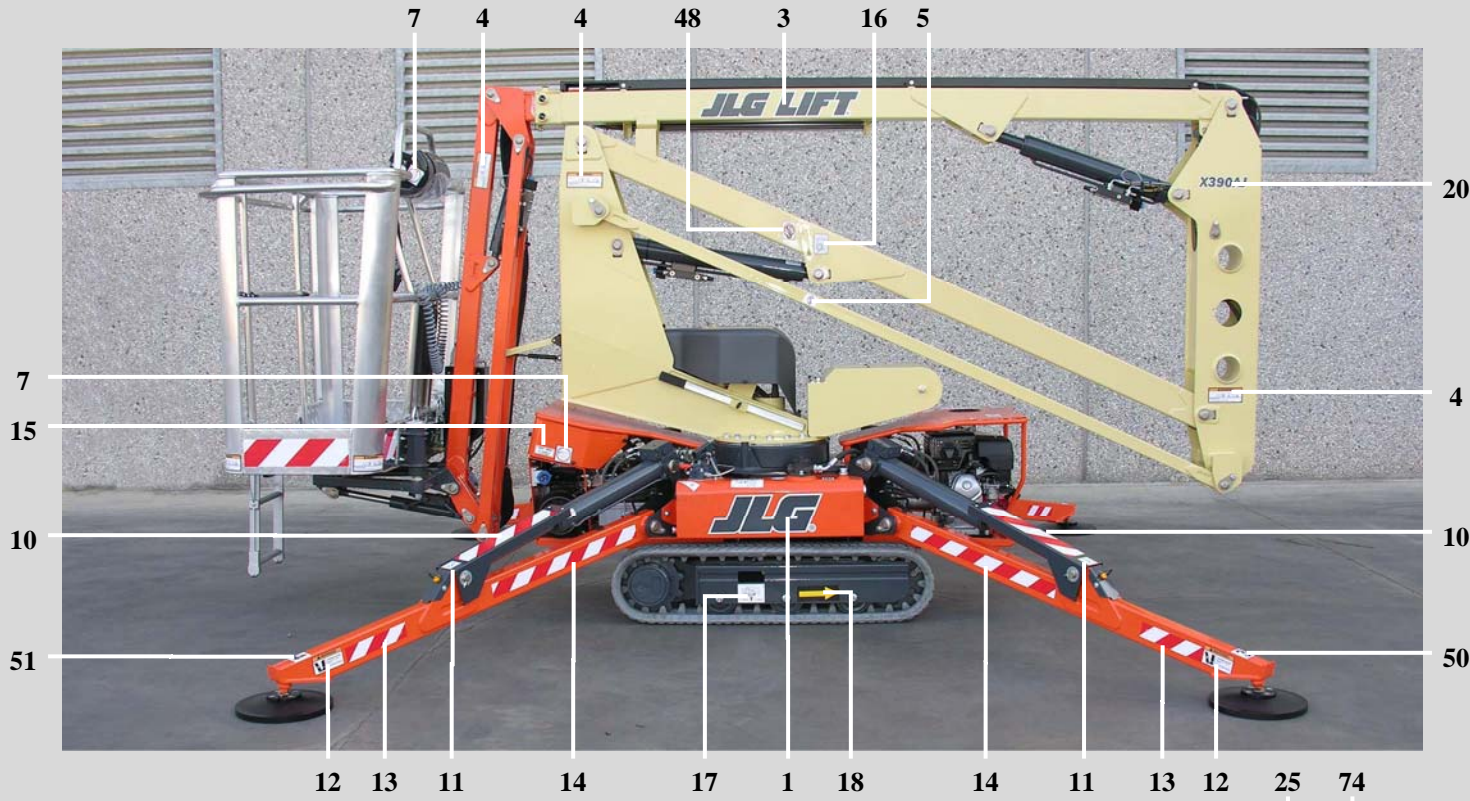

KIT ADESIVI - X390AJ

SET OF DECALS - X390AJ

KIT COLLANTS - X390AJ

AUFKLEBERSATZ - X390AJ

KIT ADHESIVOS - X390AJ

ADHESIEKIT - X390AJ

Cod. 17065200

Ed. 04/06/2013

Tav 02

Cod. 17065200 (no a ricambio/no spare kit)

KIT ADESIVI PIATTAFORMA AEREA /
AERIAL PLATFORM KIT STICKERS

JLG - X390AJ

17065200 POSIZIONE ADESIVI / POSITION STICKERS JLG - X390AJ Aggiornato il 04/06/2013			IN LINGUA	JLG
			VOLTAGGIO	
POSIZIONE	CODICE	REV.	DESCRIZIONE	QUANTITA'
01	07060500	A	ADESIVO LOGO JLG L=432x150MM	02
02				
03	07060600	A	ADESIVO LOGO JLG LIFT L=624x100 MM	02
04				
05	07056700	A	ADESIVO JLG DIVIETO DI SOLLEVAMENTO L=40X54,88	02
06	1701640	A	ADESIVO JLG LEGGERE IL MANUALE L= 69,85x69,85 MM	01
07	1001125483	A	ADESIVO JLG VIETATO LAVARE L=63,5X63,5 MM	06
08				
09				
10	06039900	A	ADESIVO CON RIGHE BIANCHE ROSSE L= 420 X 80	04
11	07042700	A	ADESIVO JLG PRESSIONE PIEDINI LL1472 P= 1,7 Kg/cm2 L= 50x50	04
12				
13	06040100	A	ADESIVO CON RIGHE BIANCHE ROSSE L= 240 X 50	08
14	06039600	A	ADESIVO CON RIGHE BIANCHE ROSSE L= 700 X 50	08
15				
16	1703814	A	ADESIVO JLG ATTACCO ANCORAGGIO ANCORAGGIO L=55,56X76,2 MM	02
17	07042800	A	ADESIVO JLG PRESSIONE TOTALE AL SUOLO LL1472 F=1658 kg L= 100x69	02
18	06040500	A	ADESIVO DIREZ. TRASLAZIONE FRECCIA GIALLA SFONDO NERO L=61 X 160	02
19				
20	07061800	A	ADESIVO JLG LOGO PIATTAFORMA AEREA CINGOLATA X390AJ L=200X43,3 MM	02
21	06941900	A	ADESIVO SELETTORE A CHIAVE 2° TELECOMANDO LL14.72 IIIS L= 101X44	01
22				
23	1701542	A	ADESIVO JLG CARBURANTE BENZINA L= 101X63,5	01
23	1701505	A	ADESIVO JLG CARBURANTE DIESEL L= 50,8X63,5	01

17065200 POSIZIONE ADESIVI / POSITION STICKERS JLG - X390AJ Aggiornato il 04/06/2013	IN LINGUA	JLG
	VOLTAGGIO	

POSIZIONE	CODICE	REV.	DESCRIZIONE	QUANTITA'
24				
25	06056300	A	ADESIVO PERICOLO SCOTTATURE L=60X51 TRIANGOLARE SFONDO GIALLO	01
26				
27	06040000	A	ADESIVO CON RIGHE BIANCHE ROSSE L= 190 X 100	02
28	06086700	A	ADESIVO CON RIGHE BIANCHE E ROSSE L=430X100	04
29				
30				
31				
32				
33	1706898	A	ADESIVO JLG EMERGENCY STOP Ø EST.57,15 Ø INT. 30,58	01
34				
35				
36				
37	07071200	A	ADESIVO JLG PUNTO DI SOLLEVAMENTO L= 40X66 MM	04
38				
39	06039700	A	ADESIVO CON RIGHE BIANCHE ROSSE L= 700 X 80	01
40				
41	06040200	A	ADESIVO POMPA MANUALE PIATTAFORME L= 86X34	01
42				
43				
44	1701504	A	ADESIVO JLG OLIO IDRAULICO L=50,8x63,5 MM	01
45	06165000	A	ADESIVO LIVELLO OLIO IDRAULICO Ø50 SFONDO BIANCO	01
46				
47	07042900	A	ADESIVO JLG MANTENERE 1 METRO DI DISTANZA LL1472 L=75X35	01

17065200 POSIZIONE ADESIVI / POSITION STICKERS JLG - X390AJ Aggiornato il 04/06/2013	IN LINGUA	JLG
	VOLTAGGIO	

POSIZIONE	CODICE	REV.	DESCRIZIONE	QUANTITA'
48	1701499	A	ADESIVO JLG DIVIETO DI SOLLEVAMENTO L= 55,56X76 MM	02
49				
50	06555700	A	ADESIVO N° 3 L=50X60 BIANCO	01
51	06555800	A	ADESIVO N° 4 L=50X60 BIANCO	01
52	06555600	A	ADESIVO NR 2 L=50X60 BIANCO	01
53	06555500	A	ADESIVO NR 1 L=50X60 BIANCO	01
54				
55				
56				
57	06232100	A	ADESIVO "ATTENZIONE BENZINA INFIAMMABILE" 7 LINGUE L= 90X171	01
58	06060000	A	ADESIVO LIVELLO OLIO MOTORE Ø50mm	01
59	1702155	A	ADESIVO JLG STACCABATTERIA L= 63,5X50,80 MM	01
60				
61				
62	1704277	A	ADESIVO JLG ATTACCO CINTURE DI SICUREZZA L= 76,2X19,05 MM	02
63				
64				
65				
66				
67				
68				
69				
70				
71				

**KIT ADESIVI IN LINGUA /
LANGUAGE KIT STICKERS
JLG - X390AJ**

Cod. (no a ricambio/no spare kit)

170652GB

170652FR

170652ES

170652PT

170652** ADESIVI IN LINGUA / ADHESIVES IN LANGUAGE JLG - X390AJ Aggiornato il 04/06/2013	IN LINGUA	JLG
	VOLTAGGIO	

POSIZIONE	CODICE	REV.	DESCRIZIONE	QUANTITA'
	170652GB			
04	07056100	A	ADESIVO JLG PERICOLO SCHIACCIAMENTO L= 140x60,71 MM	10
12	07056200	A	ADESIVO JLG ATTACCO SCHIACCIAMENTO ARTO INFERIORE L= 110x60 MM	08
15	07056400	B	ADESIVO JLG PERICOLO 120V - 60HZ L= 75x32,68 MM	04
15	07056300	A	ADESIVO JLG PERICOLO 220V - 50/60HZ L= 75X18,75 MM	04
22	07045600	A	ADESIVO ANSI COMANDI LEVE DISTRIBUTORE PARTE AEREA LL1472 L=234X51	01
24	07082400	B	ADESIVO JLG ANSI ISTRUZIONI DISCESA DI EMERG. X390AJ L=280 X195MM - GB	01
29	07051000	A	ADESIVO JLG PERICOLO DI CADUTA - SBLOCCARE SOLO NEI CASI PREVISTI L= 50X50 MM	02
30	07051100	A	ADESIVO JLG PERICOLO CADUTA - RIPRISTINARE I TAPPI L=196,5x35 MM	01
31	07042200	A	ADESIVO JLG SISTEMA BYPASS TRASLAZIONE L= 30X50	01
32	07042100	A	ADESIVO JLG SISTEMA BYPASS PARTE AEREA L=30X50	01
35	1706128	E	ADESIVO JLG PERICOLO DI FOLGORAZIONE L=120,65x91,50 MM	06
42	07050300	A	ADESIVO CARICO MAX IN CESTA ANSI PER JLG L=1963,85x76,2 MM	02
43	1702901	A	ADESIVO JLG ISTRUZIONI DISCESA EMERGENZA / POMPA MANUALE L=114,3x58,73MM	02
54	07045400	A	ADESIVO ANSI COMANDI DISTRIBUTORE PARTE CARRO SX LL1472 L=180X50	01
55	07045500	A	ADESIVO ANSI COMANDI DISTRIBUTORE PARTE CARRO DX LL1472 L=180X50	01
60	07045300	A	ADESIVO ANSI AVVIAMENTO MOTORE DA TERRA IIIS L=72X35	01
64	1706386	A	ADESIVO JLG PERICOLO CADUTE L=196,85x76,2 MM	01
65	1706387	A	ADESIVO JLG PERICOLO SCHIACCIAMENTO L=177,80x69,85 MM	01
66	1706133	C	ADESIVO JLG PERICOLO RIBALTAMENTO L=139,7X68,85 MM	01
67	07058600	A	ADESIVO JLG POSIZIONE STABILIZZATORI X390, X550	01
68	1706385	C	ADESIVO JLG SCORRIMENTO SBARRA CHIUSURA CESTO L=184,15X25,4 MM	01

AGGIORNATO IL / UPDATED 21/11/2014

Cod. 17107300 (no a ricambio/no spare kit)

KIT INTEGRAZIONE ADESIVI PER PIATTAFORME AEREE LITHIUM-ANSI

INTEGRATION KIT STICKERS PLATFORMS LITHIUM-ANSI

X390AJ - X500AJ - X550AJ - X600AJ - X700AJ

Da usare in aggiunta ai seguenti kit / To be use in addition to the following kits

X390AJ - cod.17065200

X500AJ - cod.17224100

X550AJ - cod.17065300

X600AJ - cod. 17485000

X700AJ - cod.17065400

+ kit in lingua non inclusi nel codice generale e non gestiti a ricambio

language code not included in the standard kit and no spare kit

•
+171073GB

+ 171073FR

+ 171073ES

+ 171073PT



9



16



4

5

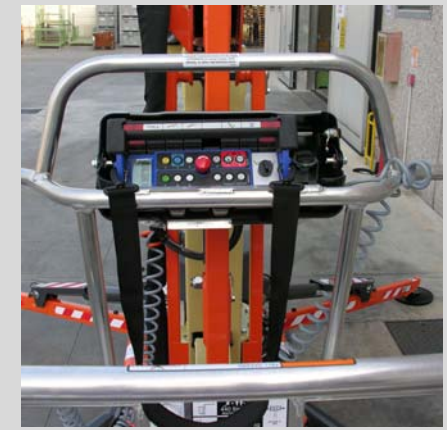

KIT ADESIVI - X390AJ

SET OF DECALS - X390AJ

KIT COLLANTS - X390AJ

AUFKLEBERSATZ -X390AJ

KIT ADHESIVOS -X390AJ

ADHESIEKIT -X390AJ

cod. 17107300

Ed. 21/11/2014

Tav 01

9



1



4

17

19

4



13



KIT ADESIVI - X390AJ

SET OF DECALS -X390AJ

KIT COLLANTS -X390AJ

AUFKLEBERSATZ -X390AJ

KIT ADHESIVOS -X390AJ

ADHESIEKIT -X390AJ

cod. 17107300

Ed. 21/11/2014

Tav 02

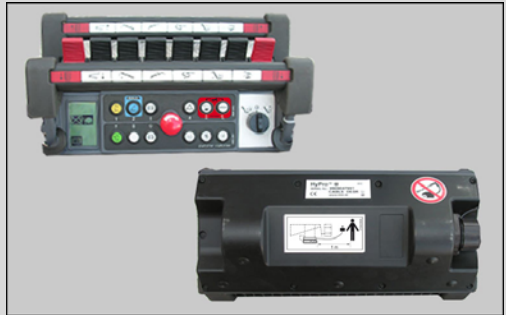

9



16



4



5



	KIT ADESIVI - X500AJ	AUFKLEBERSATZ - X500AJ	cod. 17107300	
	SET OF DECALS - X500AJ	KIT ADHESIVOS - X500AJ		
	KIT COLLANTS - X500AJ	ADHESIEKIT - X500AJ	Ed. 21/11/2014	Tav 01

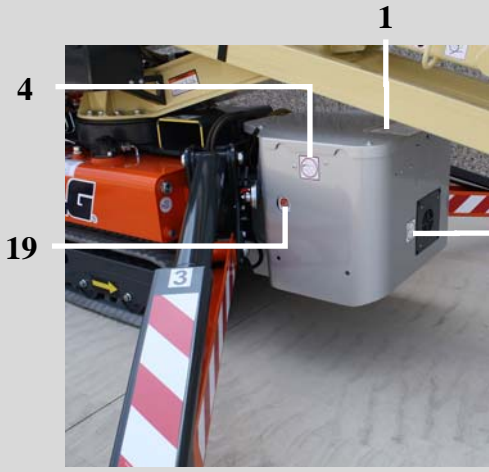
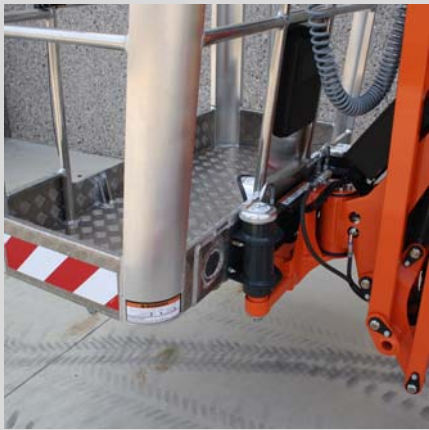

KIT ADESIVI - X500AJ

SET OF DECALS - X500AJ

KIT COLLANTS - X500AJ

AUFKLEBERSATZ - X500AJ

KIT ADHESIVOS - X500AJ

ADHESIEKIT - X500AJ

cod. 17107300

Ed. 21/11/2014

Tav 02



16



9

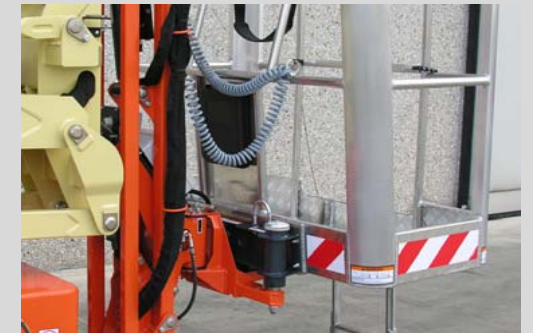

1



4

4

5



KIT ADESIVI - X550AJ

SET OF DECALS - X550AJ

KIT COLLANTS - X550AJ

AUFKLEBERSATZ - X550AJ

KIT ADHESIVOS - X550AJ

ADHESIEKIT - X550AJ

cod. 17107300

Ed. 21/11/2014

Tav 01



4
17

9



13

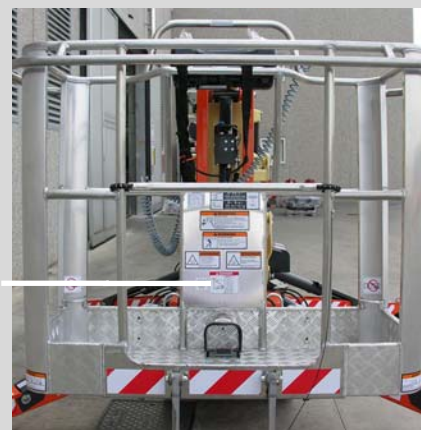

KIT ADESIVI - X550AJ

SET OF DECALS - X550AJ

KIT COLLANTS - X550AJ

AUFKLEBERSATZ - X550AJ

KIT ADHESIVOS - X550AJ

ADHESIEKIT - X550AJ

cod. 17107300

Ed. 21/11/2014

Tav 02



4

5



16

9



4



KIT ADESIVI - X600AJ

SET OF DECALS - XX600AJ

KIT COLLANTS - X600AJ

AUFKLEBERSATZ - X600AJ

KIT ADHESIVOS - X600AJ

ADHESIEKIT - X600AJ

cod. 17107300

Ed. 21/11/2014

Tav 01



9

4



13

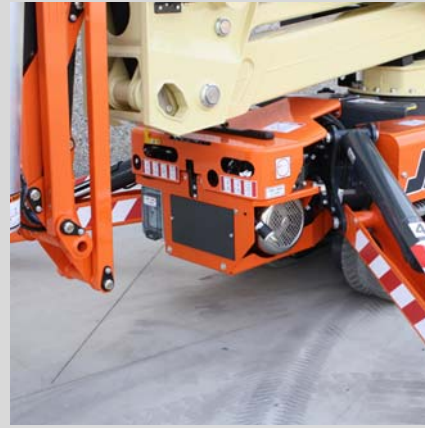

1

18

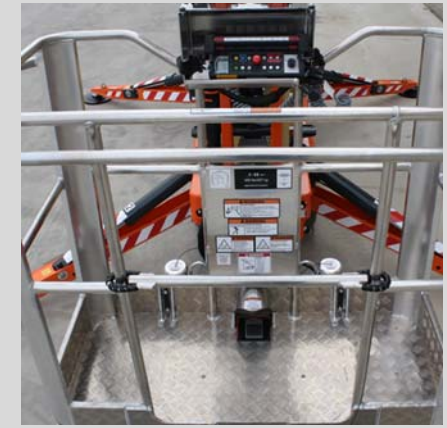

KIT ADESIVI - X600AJ

SET OF DECALS - XX600AJ

KIT COLLANTS - X600AJ

AUFKLEBERSATZ - X600AJ

KIT ADHESIVOS - X600AJ

ADHESIEKIT - X600AJ

cod. 17107300

Ed. 21/11/2014

Tav 02

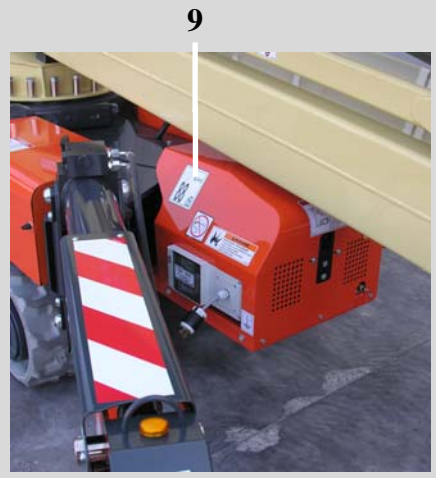
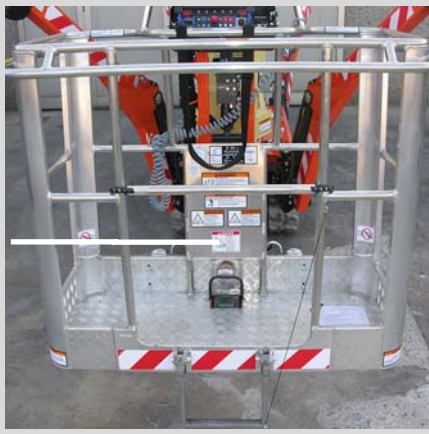

KIT ADESIVI - X700AJ

SET OF DECALS - X700AJ

KIT COLLANTS - X700AJ

AUFKLEBERSATZ - X700AJ

KIT ADHESIVOS -X700AJ

ADHESIEKIT -X700AJ

cod. 17107300

Ed. 21/11/2014

Tav 01



Sotto il coperchio / under the lid

KIT ADESIVI -X700AJ

SET OF DECALS -X700AJ

KIT COLLANTS -X700AJ

AUFKLEBERSATZ -X700AJ

KIT ADHESIVOS -X700AJ

ADHESIEKIT -X700AJ

cod. 17107300

Ed. 21/11/2014

Tav 02

Cod. 17107300 (no a ricambio/no spare kit)

KIT INTEGRAZIONE ADESIVI PIATTAFORME AEREE LITHIUM-ANSI
INTEGRATION KIT STICKERS PLATFORMS LITHIUM-ANSI
X390AJ - X500AJ - X550AJ - X600AJ - X700AJ

Da usare in aggiunta ai seguenti kit / To be use in addition to the following kits

X390AJ - cod.17065200

X500AJ - cod.17224100

X550AJ - cod.17065300

X600AJ - cod. 17485000

X700AJ - cod.17065400

17107300 POSIZIONE ADESIVI /
POSITION STICKERS
Aggiornato il / Updated on 21/11/2014

IN LINGUA / LANGUAGE

JLG

VOLTAGGIO / VOLTAGE

POS.	COD.	REV.	DESCRIZIONE / DESCRIPTION	Q.tà
01				
02				
03				
04	1001125483	A	ADESIVO JLG VIETATO LAVARE L=63,5X63,5 MM	03
05	06506400	B	ADESIVO " CHIAVE DI ACCENSIONE" ESTERNO Ø 49 FORO Ø 22 SERIE LITHIUM ION	01
06				
07				
08				
09	06520600	B	ADESIVO RUMORE 88 dB L=90x100	02
10				
11				
12				
13				
14				
15				
16				
17	07264700	A	ADESIVO IND. LED CARICABATT. 48V (Ø EST.31MM Ø INT.6 MM) VECCHIO BMS (FINO A C170000329)	01
18	07264800	A	ADESIVO INDICATORE LED RICARICA BATTERIE Ø EST.21MM Ø INT.4 MM (X600AJ - X700AJ)	02
19	07394800	A	ADESIVO IND. LED CARICABATT. 48V (Ø EST.31MM Ø INT.6 MM) NUOVO BMS/4 (DA C170000330)	01
20				
21				
22				

**KIT ADESIVI IN LINGUA PER /
LANGUAGE KIT STICKERS FOR
X390AJ - X500AJ - X550AJ - X600AJ - X700AJ**

Cod. (no a ricambio/*no spare kit*)

+ 171073GB

+ 171073FR

+ 171073ES

+ 171073PT

171073 POSIZIONE ADESIVI IN LINGUA /**
POSITION LANGUAGE STICKERS
Aggiornato il / Updated on 21/11/2014

IN LINGUA / LANGUAGE

JLG

VOLTAGGIO / VOLTAGE

POS.	COD.	REV.	DESCRIZIONE / DESCRIPTION	Q.tà
	171073GB		ADESIVI PIATTAF. AEREA X390AJ - X14J - X17J - X550AJ - X19J - X700AJ - X23J - LINGUA INGLESE	
01	07107200	A	ADESIVO JLG-ANSI ATTENZIONE PERICOLO BATTERIE - ING L=210X145 MM	01
07				
10				
11				
12				
13	07107100	A	ADESIVO JL-ANSI RICARICARE LE BATTERIE DOPO L'USO ALMENO OGNI 3 MESI - ING L=50x50 MM	01
14				
15				01
16	07110300	A	ADESIVO JLG ANSI ISTRUZIONI DISCESA DI EMERG. X390AJ LITHIUM - ING L=280 X195MM	01
16	-----	A	ADESIVO JLG ANSI ISTRUZ. DISCESA DI EMERG. X500AJ / Utilizzare l' adesivo della motorizzazione con motore termico - vedere kit lingua inglese cod. 172241GB -Use the thermal sticker version - see the En-	01
16	07110200	A	ADESIVO JLG ANSI ISTRUZIONI DISCESA DI EMERG. X550AJ LITHIUM L=280 X195MM - GB	01
16	-----	A	ADESIVO JLG ANSI ISTRUZ. DISCESA DI EMERG. X600AJ / Utilizzare l' adesivo della motorizzazione con motore termico - vedere kit lingua inglese cod. 174850GB - Use the thermal sticker version - see the English language kit cod. 172241GB	01
16	07110100	A	ADESIVO JLG ANSI ISTRUZIONI DISCESA DI EMERG. X700AJ LITHIUM - ING L=280 X195MM	01

Cod. 17187700 (no a ricambio/no spare kit)

**KIT INTEGRAZIONE ADESIVI PER PIATTAFORME AEREE LITHIUM-CE /
INTEGRATION KIT STICKERS PLATFORMS LITHIUM-CE**

X14J - X14J-H - X17J - X17JPLUS - X19J - X20JPLUS - X23J

Da usare in aggiunta a / To use in added to

**X14J - cod.17063500 / X14J-H - cod.17065000 / X17J cod.17063700 / X17JPLUS cod. 17242800 /
X19J cod.17063200 / X20JPLUS cod. 17351800 / X23J cod.17062700**

+ kit in lingua non inclusi nel codice generale e non gestiti a ricambio

+ *language code not included in the standard kit and no spare kit*

+171877IT + 171877GB + 171877FR + 171877DE + 171877ES + 171877NL

+ 171877PT + 171877SW + 171877DA + 171877NO + 171877JA



9



16



4



5



KIT ADESIVI - X14J

SET OF DECALS - X14J

KIT COLLANTS - X14J

AUFKLEBERSATZ - X14J

KIT ADHESIVOS - X14J

ADHESIEKIT - X14J

cod. 17187700

Ed. 02/05/2013

Tav 01

9



1



4
17

4



13



KIT ADESIVI - X14J

SET OF DECALS - X14J

KIT COLLANTS - X14J

AUFKLEBERSATZ - X14J

KIT ADHESIVOS - X14J

ADHESIEKIT - X14J

cod. 17187700

Ed. 02/05/2013

Tav 02



9



16



4



5



KIT ADESIVI - X17J

SET OF DECALS - X17J

KIT COLLANTS - X17J

AUFKLEBERSATZ - X17J

KIT ADHESIVOS - X17J

ADHESIEKIT - X17J

cod. 17187700

Ed. 02/05/2013

Tav 01



13

1

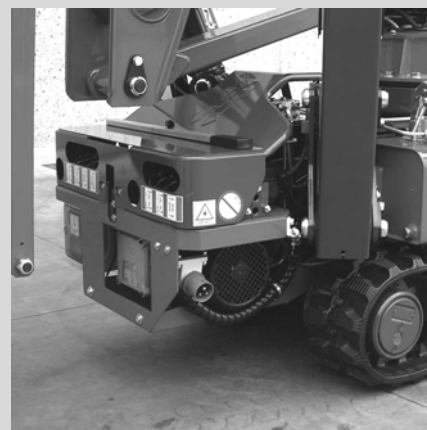

4

17

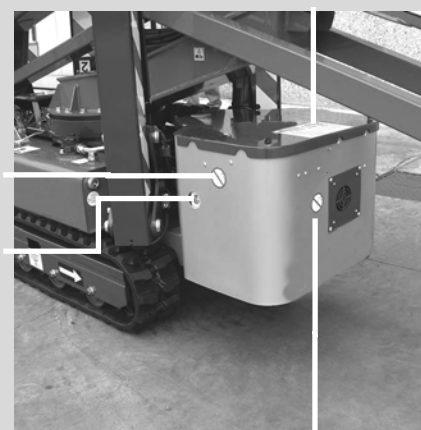

4



KIT ADESIVI - X17J

SET OF DECALS - X17J

KIT COLLANTS - X17J

AUFKLEBERSATZ - X17J

KIT ADHESIVOS - X17J

ADHESIEKIT - X17J

cod. 17187700

Ed. 02/05/2013

Tav 02



9



16



1

4

4



5



KIT ADESIVI - X17JPLUS

SET OF DECALS - X17JPLUS

KIT COLLANTS - X17JPLUS

AUFKLEBERSATZ - X17JPLUS

KIT ADHESIVOS - X17JPLUS

ADHESIEKIT - X17JPLUS

cod. 17187700

Ed. 02/05/2013

Tav 01



9



13



4

17



3



KIT ADESIVI - X17JPLUS

SET OF DECALS - X17JPLUS

KIT COLLANTS - X17JPLUS

AUFKLEBERSATZ - X17JPLUS

KIT ADHESIVOS - X17JPLUS

ADHESIEKIT - X17JPLUS

cod. 17187700

Ed. 02/05/2013

Tav 02



16



9



KIT ADESIVI - X19J

SET OF DECALS - X19J

KIT COLLANTS - X19J

AUFKLEBERSATZ - X19J

KIT ADHESIVOS - X19J

ADHESIEKIT - X19J

cod. 17187700

Ed. 02/05/2013

Tav 01



9

4

17



13



KIT ADESIVI - X19J

SET OF DECALS - X19J

KIT COLLANTS - X19J

AUFKLEBERSATZ - X19J

KIT ADHESIVOS - X19J

ADHESIEKIT - X19J

cod. 17187700

Ed. 02/05/2013

Tav 02



9



16



1

4

4



5



KIT ADESIVI - X20JPLUS

SET OF DECALS - X20JPLUS

KIT COLLANTS - X20JPLUS

AUFKLEBERSATZ - X20JPLUS

KIT ADHESIVOS - X20JPLUS

ADHESIEKIT - X20JPLUS

cod. 17187700

Ed. 02/05/2013

Tav 01



9



13



4

17



3



KIT ADESIVI - X20JPLUS

SET OF DECALS - X20JPLUS

KIT COLLANTS - X20JPLUS

AUFKLEBERSATZ - X20JPLUS

KIT ADHESIVOS - X20JPLUS

ADHESIEKIT - X20JPLUS

cod. 17187700

Ed. 02/05/2013

Tav 02



4



13

9



KIT ADESIVI - X23J

SET OF DECALS - X23J

KIT COLLANTS - X23J

AUFKLEBERSATZ - X23J

KIT ADHESIVOS - X23J

ADHESIEKIT - X23J

cod. 17187700

Ed. 02/05/2013

Tav 01

Sotto il carter / Under the hood

18

4



18



1

16



4



9



KIT ADESIVI - X23J

SET OF DECALS - X23J

KIT COLLANTS - X23J

AUFKLEBERSATZ - X23J

KIT ADHESIVOS - X23J

ADHESIEKIT - X23J

cod. 17187700

Ed. 02/05/2013

Tav 02

Cod. 17187700 (*no a ricambio/no spare kit*)

KIT INTEGRAZIONE ADESIVI PER PIATTAFORME AEREE LITHIUM-CE
INTEGRATION KIT STICKERS PLATFORMS LITHIUM-CE
X14J - X14J-H - X17J - X17JPLUS - X19J - X23J

**17187700 POSIZIONE ADESIVI 7 LINGUE /
POSITION LANGUAGE STICKERS**
Aggiornato il / Updated 02/05/2013

IN LINGUA / LANGUAGE

JLG

VOLTAGGIO / VOLTAGE

POS.	COD.	REV.	DESCRIZIONE / DESCRIPTION	Q.tà
	17187700		KIT INTEGRAZIONE ADESIVI PER PIATTAFORME AEREE CE LITHIUM X14J - X14J-H - X17J - -X19J -	
01				
02				
03				
04	1001125483	A	ADESIVO JLG VIETATO LAVARE L=63,5X63,5 MM	03
05	06506400	B	ADESIVO " CHIAVE DI ACCENSIONE" ESTERNO Ø 49 FORO Ø 22 SERIE LITHIUM ION	01
06				
07				
08				02
09	06520600	B	ADESIVO RUMORE 88 dB L=90x100	02
10				
11				
12				
13				
14				
15				
16				
17	07264700	A	ADESIVO INDICATORE LED CARICABATTERIE 48V (Ø EST.31MM Ø INT.6 MM) VECCHIO BMS (FINO A C170000329)	01
	07394800	A	ADESIVO INDICATORE LED CARICABATTERIE 48V (Ø EST.31MM Ø INT.6 MM) NUOVO BMS/4 (DA C170000330)	01
18	07264800	A	ADESIVO INDICATORE LED RICARICA BATTERIE Ø EST.21MM Ø INT.4 MM	02

**KIT ADESIVI IN LINGUA PER /
LANGUAGE KIT STICKERS FOR
X14J - X14J-H - X17J - X17JPLUS - X19J - X20JPLUS - X23J**

Cod. (no a ricambio/no spare kit)

**- 171877IT + 171877GB + 171877FR + 171877DE + 171877ES
+ 171877NL + 171877PT + 171877SW + 171877DA + 171877NO
+ 171877JA**

171877 POSIZIONE ADESIVI IN LINGUA /
POSITION LANGUAGE STICKERS**
Aggiornato il / Updated 02/05/2013

IN LINGUA / LANGUAGE

JLG

VOLTAGGIO / VOLTAGE

POS.	COD.	REV.	DESCRIZIONE / DESCRIPTION	Q.tà
	171877IT		KIT ADESIVI INTEGR. PIATT. AEREA X14J-H- X14J - X17J - X19J X23J LITHIUM - LINGUA ITALIANO	
01	07188700	A	ADESIVO JLG ATTENZIONE PERICOLO BATTERIE - ITA L=210X145 MM	01
07				
10				
11				
12				
13	07188100	A	ADESIVO JLG RICARICARE LE BATTERIE DOPO L'USO O ALMENO OGNI 3 MESI L=50x50 MM – ITA	01
14				
16 solo X14J-H	1693870003	B	ADESIVO ISTRUZIONI DISCESA EMERGENZA GL1470LI ITALIANO GIALLO L=290x175 MM (**)	01
16 solo X17J	1705720001	A	ADESIVO ISTRUZIONI DISCESA DI EMERGENZA GL14703S LITHIUM ITALIANO L=290X175 MM (**)	01
16			Per le / for X14J - X17JPLUS - X19J - X20JPLUS - X23J Vedere discesa di emergenza motore termico / See emergency lowering heat engine	
	171877GB		KIT ADESIVI INTEGR. PIATT. AEREA X14J-H- X14J - X17J - X19J X23J LITHIUM - LINGUA INGLESE	
01	07201700	A	ADESIVO JLG ATTENZIONE PERICOLO BATTERIE - ING L=210X145 MM	01
07				
10				
11				
12				
13	07202100	A	ADESIVO JLG RICARICARE LE BATTERIE DOPO L'USO O ALMENO OGNI 3 MESI L=50x50 MM -ING	01
14				
16 per X14J-H	1693870004	B	ADESIVO ISTRUZIONI DISCESA EMERGENZA GL1470LI INGLESE GIALLO L=290x175 MM	01
16 per X17J	1705720002	A	ADESIVO ISTRUZIONI DISCESA DI EMERGENZA GL14703S LITHIUM INGLESE L=290X175 MM	01
16			Per le / for X14J - X17JPLUS - X19J - X20JPLUS - X23J Vedere discesa di emergenza motore termico / See emergency lowering heat engine	

171877 POSIZIONE ADESIVI IN LINGUA /
POSITION LANGUAGE STICKERS**
Aggiornato il / Updated 02/05/2013

IN LINGUA / LANGUAGE

JLG

VOLTAGGIO / VOLTAGE

POS.	COD.	REV.	DESCRIZIONE / DESCRIPTION	Q.tà
	171877FR		KIT ADESIVI INTEGR. PIATT. AEREA X14J-H- X14J - X17J - X19J X23J LITHIUM - LINGUA FRANCESE	
01	07201800	A	ADESIVO JLG ADESIVO ATTENZIONE PERICOLO BATTERIE - FRA L=210X145 MM	01
07				
10				
11				
12				
13	07202200	A	ADESIVO JLG RICARICARE LE BATTERIE DOPO L'USO ALMENO OGNI 3 MESI - FRA L=50x50 MM	01
14				
16 per X14J-H	1693870005	B	ADESIVO ISTRUZIONI DISCESA EMERGENZA GL1470LI FRANCESE GIALLO L=290x175 MM (**)	01
16 per X17J	1705720003	A	ADESIVO ISTRUZIONI DISCESA DI EMERGENZA GL14703S LITHIUM FRANCESE L=290X175 MM (**)	01
16	/	/	Per le / for X14J - X17JPLUS - X19J - X20JPLUS - X23J Vedere discesa di emergenza motore termico / See emergency lowering heat engine	01
	171877DE		KIT ADESIVI INTEGR. PIATT. AEREA X14J-H- X14J - X17J - X19J X23J LITHIUM - LINGUA TEDESCO	
01	07188800	A	ADESIVO JLG ATTENZIONE PERICOLO BATTERIE - TED L=210X145 MM	01
07				
10				
11				
12				
13	07188200	A	ADESIVO JLG RICARICARE LE BATTERIE DOPO L'USO O ALMENO OGNI 3 MESI L=50x50 MM –TED	01
14				
16 per X14J-H	1693870006	B	ADESIVO ISTRUZIONI DISCESA EMERGENZA GL1470LI TEDESCO GIALLO L=290x175 MM (**)	01
16 per X17J	1705720004	A	ADESIVO ISTRUZIONI DISCESA DI EMERGENZA GL14703S LITHIUM TEDESCO L=290X175 MM (**)	01
16	/	/	Per le / for X14J - X17JPLUS - X19J - X20JPLUS - X23J Vedere discesa di emergenza motore termico / See emergency lowering heat engine	01

171877 POSIZIONE ADESIVI IN LINGUA /
POSITION LANGUAGE STICKERS**
Aggiornato il / Updated 02/05/2013

IN LINGUA / LANGUAGE

JLG

VOLTAGGIO / VOLTAGE

POS.	COD.	REV.	DESCRIZIONE / DESCRIPTION	Q.tà
	171877ES		KIT ADESIVI INTEGR. PIATT. AEREA X14J-H- X14J - X17J - X19J X23J LITHIUM - LINGUA SPAGNOLO	
01	07201900	A	ADESIVO JLG ATTENZIONE PERICOLO BATTERIE - SPA L=210X145 MM -	01
07				
10				
11				
12				
13	07202300	A	ADESIVO JLG RICARICARE LE BATTERIE DOPO L'USO ALMENO OGNI 3 MESI - SPA L=50x50 MM	01
14				
16 per X14J-H	1693870007	B	ADESIVO ISTRUZIONI DISCESA EMERGENZA GL1470LI SPAGNOLO GIALLO L=290x175 (**)	01
16 per X17J	1705720005	A	ADESIVO ISTRUZIONI DISCESA DI EMERGENZA GL14703S LITHIUM SPAGNOLO L=290X175 MM (**)	01
16			Per le / for X14J - X17JPLUS - X19J - X20JPLUS - X23J Vedere discesa di emergenza motore termico / See emergency lowering heat engine	
	171877NL		KIT ADESIVI INTEGR. PIATT. AEREA X14J-H- X14J - X17J - X19J X23J LITHIUM - LINGUA OLANDESE	
01	07188900	A	ADESIVO JLG ATTENZIONE PERICOLO BATTERIE - OLA L=210X145 MM	01
07				
10				
11				
12				
13	07188300	A	ADESIVO JLG RICARICARE LE BATTERIE DOPO L'USO O ALMENO OGNI 3 MESI L=50x50 MM – OLA	01
14				
16 per X14J-H	1693870008	B	ADESIVO ISTRUZIONI DISCESA EMERGENZA GL1470LI OLANDESE GIALLO L=290x175 MM (**)	01
16 per X17J	1705720006	A	ADESIVO ISTRUZIONI DISCESA DI EMERGENZA GL14703S LITHIUM OLANDESE L=290X175 MM (**)	01
16			Per le / for X14J - X17JPLUS - X19J - X20JPLUS - X23J Vedere discesa di emergenza motore termico / See emergency lowering heat engine	01

171877 POSIZIONE ADESIVI IN LINGUA /
POSITION LANGUAGE STICKERS**
Aggiornato il / Updated 02/05/2013

IN LINGUA / LANGUAGE

JLG

VOLTAGGIO / VOLTAGE

POS.	COD.	REV.	DESCRIZIONE / DESCRIPTION	Q.tà
	171877PT		KIT ADESIVI INTEGR. PIATT. AEREA X14J-H-X14J-X17J-X19J-X23J LITHIUM - LINGUA PORTOGHESE	
01	07202000	A	ADESIVO JLG ATTENZIONE PERICOLO BATTERIE - POR L=210X145 MM	01
07				
10				
11				
12				
13	07202400	A	ADESIVO JLG RICARICARE LE BATTERIE DOPO L'USO O ALMENO OGNI 3 MESI L=50x50 MM – POR	01
14				
16 per X14J-H	1693870009	B	ADESIVO ISTRUZIONI DISCESA EMERGENZA GL1470LI PORTOGHESE GIALLO L=290x175 MM (**)	01
16 per X17J	1705720007	A	ADESIVO ISTRUZ. DISCESA DI EMERGENZA GL14703S LITHIUM PORTOGHESE L=290X175 MM (**)	01
16			Per le / for X14J - X17JPLUS - X19J - X20JPLUS - X23J Vedere discesa di emergenza motore termico / See emergency lowering heat engine	
	171877SW		KIT ADESIVI INTEGR. PIATT. AEREA X14J-H-X14J-X17J-X19J-X23J LITHIUM - SVEDESE	
01	07189000	A	ADESIVO JLG ATTENZIONE PERICOLO BATTERIE - SVE L=210X145 MM	01
07				
10				
11				
12				
13	07188400	A	ADESIVO JLG RICARICARE LE BATTERIE DOPO L'USO O ALMENO OGNI 3 MESI L=50x50 MM – SVE	01
14				
16 per X14J-H	1693870010	A	ADESIVO ISTRUZIONI DISCESA EMERGENZA GL1470LI SVEDESE GIALLO L=290x175 MM (**)	01
16 per X17J	1705720010	A	ADESIVO ISTRUZ. DISCESA DI EMERGENZA GL14703S LITHIUM SVEDESE L=290X175 MM (**)	01
16			Per le / for X14J - X17JPLUS - X19J - X20JPLUS - X23J Vedere discesa di emergenza motore termico / See emergency lowering heat engine	

171877 POSIZIONE ADESIVI IN LINGUA /
POSITION LANGUAGE STICKERS**
Aggiornato il / Updated 02/05/2013

IN LINGUA / LANGUAGE

JLG

VOLTAGGIO / VOLTAGE

POS.	COD.	REV.	DESCRIZIONE / DESCRIPTION	Q.tà
	171877DA		KIT ADESIVI INTEGR. PIATT. AEREA X14J-H-X14J-X17J-X19J-X23J LITHIUM - LINGUA DANESE	
01	07189100	A	ADESIVO JLG ATTENZIONE PERICOLO BATTERIE - DAN L=210X145 MM	01
07				
10				
11				
12				
13	07188500	A	ADESIVO JLG RICARICARE LE BATTERIE DOPO L'USO O ALMENO OGNI 3 MESI L=50x50 MM – DAN	01
14				
16 per X14J-H	1693870011	A	ADESIVO ISTRUZIONI DISCESA EMERGENZA GL1470LI SVEDESE DANESE L=290x175 MM (**)	01
16 per X17J	1705720011	A	ADESIVO ISTRUZ. DISCESA DI EMERGENZA GL14703S LITHIUM DANESE L=290X175 MM (**)	01
16			Per le / for X14J - X17JPLUS - X19J - X20JPLUS - X23J Vedere discesa di emergenza motore termico / See emergency lowering heat engine	
	171877NO		KIT ADESIVI INTEGR. PIATT. AEREA X14J-H-X14J-X17J-X19J-X23J LITHIUM - LINGUA NORVEGESE	
01	07189200	A	ADESIVO JLG ATTENZIONE PERICOLO BATTERIE - NOR L=210X145 MM	01
07				
10				
11				
12				
13	07188600	A	ADESIVO JLG RICARICARE LE BATTERIE DOPO L'USO O ALMENO OGNI 3 MESI L=50x50 MM – NOR	01
14				
16 per X14J-H	1693870012	A	ADESIVO ISTRUZIONI DISCESA EMERGENZA GL1470LI NORVEGESE GIALLO L=290x175 MM (**)	01
16 per X17J	1705720012	A	ADESIVO ISTRUZ. DISCESA DI EMERGENZA GL14703S LITHIUM NORVEGESE L=290X175 MM (**)	01
16	/	/	Per le / for X14J - X17JPLUS - X19J - X20JPLUS - X23J Vedere discesa di emergenza motore termico / See emergency lowering heat engine	

TABELLA PERNI/SPINE (PINS TABLE)

LOCKING SYSTEM
GHIERA
(LOCKNUTS CODE)
REF. TABLE BELOW

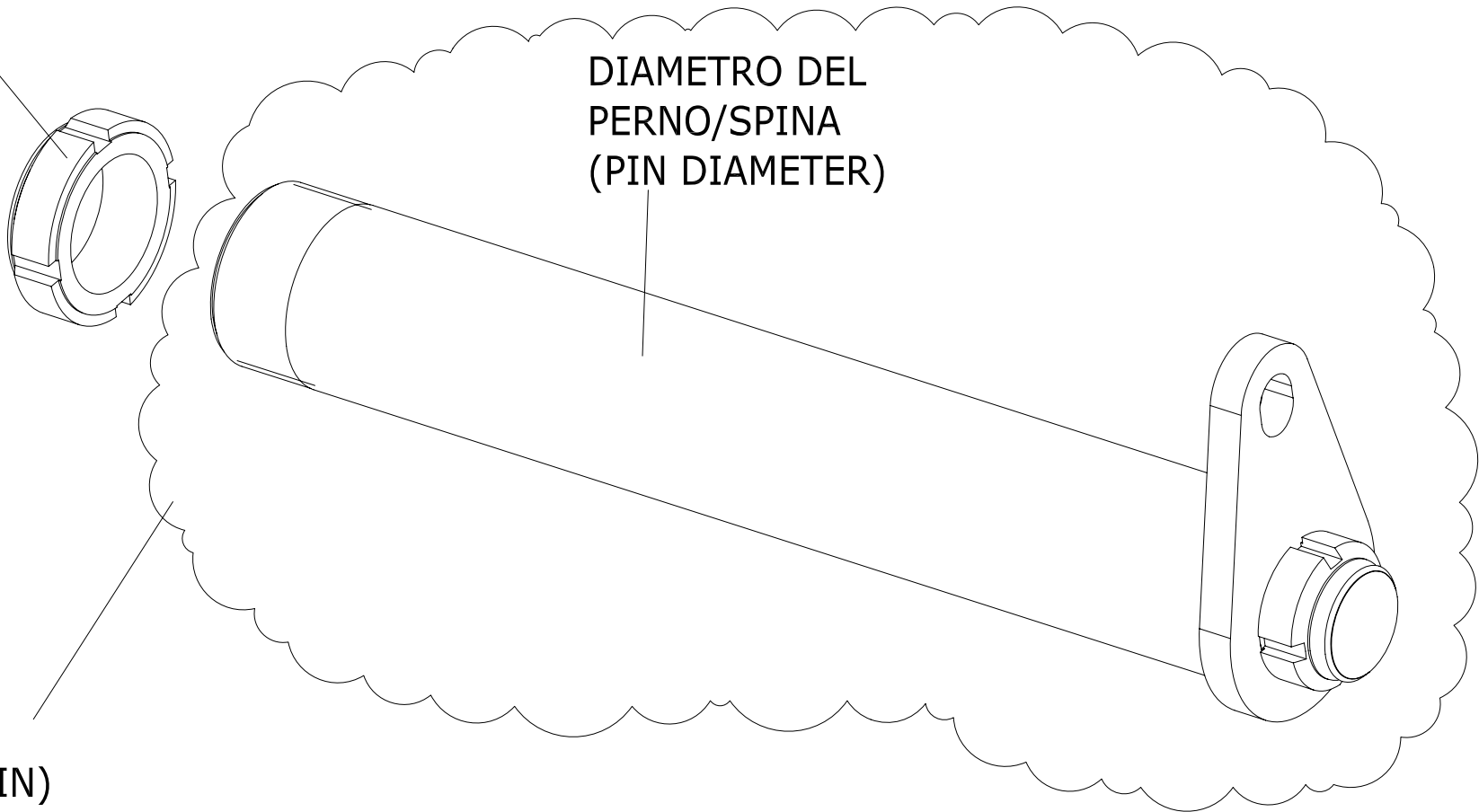

PERNO/SPINA (PIN)



IL CODICE DEL PERNO A RICAMBIO COMPRENDE LA GOCCIA MONTATA E LA GHIERA DI FISSAGGIO DELLA GOCCIA



THE CODE OF A PIN INCLUDES DROP PARTS MOUNTED AND THE LOCK NUT TO FIXING THE DROP,
ALL THESE PARTS ARE SHIPPED ALREADY MOUNTED TOGETHER

DIAMETRO DEL PERNO/SPINA mm SISTEMA METRICO (PIN DIAMETER mm METRIC)	GHIERA (LOCKNUTS CODE)	DADO (NUTS CODE)
25	BG4	
30	BG5	
35	BG3	
40	BG2	
45	BG7	
50	BG8	
20 (DIAMETER OF THREADED PART M17 PITCH=1)	BG1	
20 (DIAMETER OF THREADED PART M20 PITCH=1)	BG6	
20 (DIAMETER OF THREADED PART M20 PITCH=1,5)	BG12	



POS	Codice	U.M.	 Descrizione	 Description
BC1	BC000100	NR	COPPIGLIA 4X40	COTTER PIN 4x40
BC2	BC000200	NR	COPPIGLIA 5X40	COTTER PIN 5x40
BC3	BC000300	NR	SEEGER ESTERNO Ø20	SEEGER EXTERNAL Ø20
BC4	BC000400	NR	SEEGER ESTERNO Ø8	SEEGER EXTERNAL Ø8
BD1	BD000100	NR	Dado Esagonale Flangiato Liscio PG DIN 6923 CI 8 M 14 Z.Bianca	Hex Flange Nut DIN 6923 CI Smooth PG 8 M 14 Z. white
BD2	BD000200	NR	Dado Esagonale Basso PG DIN 936 CI 04 M 8 Z.Bianca	Low Hex nut DIN 936 PG 04 M CI 8 Z. white
BD3	BD000300	NR	Dado Esagonale Alto PG UNI 5587 CI 8 M 8 Z.Bianca	Hex Nut High PG UNI 5587 CI 8 M 8 Z. white
BD4	BD000400	NR	Dado Alto Autobloccante PG DIN 982 CI 8 M 12 Z.Bianca	High Self Locking Nut DIN 982 PG 12 CI 8 M Z. white
BD5	BD000500	NR	Dado Alto Autobloccante PG DIN 982 CI 8 M 8 Z.Bianca	High Self Locking Nut DIN 982 PG CI 8 M 8 Z. white
BD6	BD000600	NR	Dado Esagonale Alto PG UNI 5587 CI 8 M 4 Z.Bianca	Hex Nut High PG UNI 5587 M 4 CI 8 Z. white
BD7	BD000700	NR	Dado Esagonale Basso PG DIN 936 CI 04 M 6 Z.Bianca	Low Hex nut DIN 936 PG 6 CI 04 M Z. white
BD8	BD000800	NR	Dado Basso Autobloccante PG DIN 985 CI 8 M 6 Z.Bianca	Low Self-locking nut DIN 985 PG 6 CI 8 M Z. white
BD9	BD000900	NR	Dado Alto Autobloccante PG DIN 982 CI 8 M 6 Z.Bianca	High Self Locking Nut DIN 982 PG CI 8 M6 Z. white
BD10	BD001000	NR	Dado Basso Autobloccante PG DIN 985 CI 8 M 5 Z.Bianca	Low Self-locking nut DIN 985 PG CI 8 M5 Z. white
BD11	BD001100	NR	Dado Alto Autobloccante PG DIN 982 CI 8 M 5 Z.Bianca	High Self Locking Nut DIN 982 PG CI 8 M5 Z. white
BD12	BD001200	NR	Dado Alto Autobloccante PG DIN 982 CI 8 M 4 Z.Bianca	High Self Locking Nut DIN 982 PG CI 8 M4 Z. white
BD13	BD001300	NR	Dado Alto Autobloccante PG DIN 982 CI 8 M 3 Z.Bianca	High Self Locking Nut DIN 982 PG CI 8 M3 Z. white

POS	Codice	U.M.	 Descrizione	 Description
BD14	BD001400	NR	Dado Alto Autobloccante PF DIN 982 CI 8 M 20 x 1,5 Z.Bianca	High Self Locking Nut DIN 982 PF CI 8 M 20 x 1.5 Z white
BD15	BD001500	NR	Dado Alto Autobloccante PG DIN 982 CI 8 M 10 Z.Bianca	High Self Locking Nut DIN 982 PG CI 8 M10 Z. white
BD16	BD001600	NR	Dado Esagonale Alto PG UNI 5587 CI 8 M 3 Z.Bianca	Hex Nut High PG UNI 5587 CI 8 M3 Z. white
BD17	BD001700	NR	Dado Basso Autobloccante PG DIN 985 CI 8 M 8 Z.Bianca	Low Self-locking nut DIN 985 PG CI 8 M8 Z. white
BD18	BD001800	NR	Dado Alto Autobloccante PG DIN 982 CI 8 M 16 Z.Bianca	High Self Locking Nut DIN 982 PG CI 8 M16 Z. white
BD19	BD001900	NR	Dado Alto Autobloccante PF DIN 982 CI 8 M 20 x 1,5 Z.Bianca H=20 ribassato	High Self Locking Nut DIN 982 PF CI 8 M 20 x 1.5 Z White H = 20 low
BD22	BD002200	NR	Dado Alto Autobloccante PG DIN 982 CI 8 M 14 Z.Bianca	Hex Flange Nut DIN 982 CI 8 M 14 Z. white
BD23	BD002300	NR	Dado Basso Autobloccante PG DIN 985 CI 8 M 10 Z.Bianca	Low Self-locking nut DIN 985 PG CI 8 M 10 Z. white
BD24	BD002400	NR	Dado Alto Autobloccante PG DIN 982 CI 8 M 24 Z.Bianca	High Self Locking Nut DIN 982 PG CI 8 M24 Z. white
BD25	BD002500	NR	Dado Esagonale Alto PG UNI 5587 CI 8 M 6 Z.Bianca	Hex Nut High PG UNI 5587 M 6 CI 8 Z. white
BD26	BD002600	NR	Dado Esagonale Alto PG UNI 5587 CI 8 M 10 Z.Bianca	Hex Nut High PG UNI 5587 M 10 CI 8 Z. white
BD27	BD002700	NR	Dado Alto Autobloccante PG DIN 982 CI 8 M 18 Z.Bianca	High Self Locking Nut DIN 982 PG CI 8 M18 Z. white
BD28	BD002800	NR	Dado Basso Autobloccante PG DIN 985 CI 8 M 16 Z.Bianca	Low Self-locking nut DIN 985 PG CI 8 M 16 Z. white
BD29	BD002900	NR	Dado Esagonale Alto PG UNI 5587 CI 8 M 5 Z.Bianca	Hex Nut High PG UNI 5587 M 5 CI 8 Z. white
BD30	BD003000	NR	Dado Esagonale Alto PG UNI 5587 CI 12 M 5 Z.Bianca	Hex Nut High PG UNI 5587 M 5 CI 12 Z. white
BD31	BD003100	NR	Dado Esagonale Alto PG UNI 5587 CI 16 M 5 Z.Bianca	Hex Nut High PG UNI 5587 M 5 CI 16 Z. white
BD32	BD003200	NR	Dado Alto Autobloccante PG DIN 982 CI 8 M 20 Z.Bianca	High Self Locking Nut DIN 982 PG CI 8 M20 Z. white

POS	Codice	U.M.	 Descrizione	 Description
BG1	BG000100	NR	Ghiera autobloccante GN CI 6 GN 3 D. 17 x 1 Z.Bianca	Self-locking nut GN GN 3 CI 6 D. 17 x 1 Z. white
BG2	BG000200	NR	Ghiera autobloccante pesante CI 6 GUP 40 x 1,5 Z.Bianca	Self-locking nut heavy CI 6 GUP 40 x 1.5 Z white
BG3	BG000300	NR	Ghiera autobloccante pesante CI 6 GUP 35 x 1,5 Z.Bianca	Self-locking nut heavy CI 6 GUP 35 x 1.5 Z white
BG4	BG000400	NR	Ghiera autobloccante pesante CI 6 GUP 25 x 1,5 Z.Bianca	Self-locking nut heavy CI 6 GUP 25 x 1.5 Z white
BG5	BG000500	NR	Ghiera autobloccante pesante CI 6 GUP 30 x 1,5 Z.Bianca	Self-locking nut heavy CI 6 GUP 30 x 1.5 Z white
BG6	BG000600	NR	Ghiera autobloccante pesante CI 6 GUP 20 x 1 Z.Bianca	Self-locking nut heavy CI 6 GUP 20 x 1 Z. white
BG7	BG000700	NR	Ghiera autobloccante GN CI 6 GN 3 D. 45 x 1,5 Z.Bianca	NUT
BG8	BG000800	NR	Ghiera autobloccante GN CI 6 GN 3 D. 50 x 1,5 Z.Bianca	NUT
BG9	BG000900	NR	Ghiera autobloccante GN CI 6 GN 3 D. 20 x 1,5 Z.Bianca	NUT
BG10	BG001000	NR	Ghiera autobloccante ribassata CI 6 GUK 25 x 1,5 Z.Bianca	Self-locking nut lowered CI 6 GUK 25 x 1.5 Z.Bianca
BG11	BG001100	NR	Ghiera autobloccante ribassata CI 6 GUK 20 x 1 Z.Bianca	Self-locking nut lowered CI 6 GUK 20 x 1 Z.Bianca
BG12	BG001200	NR	Ghiera autobloccante ribassata CI 6 GUA 20 x 1.5 Z.Bianca	Self-locking nut lowered CI 6 GUA 20 x 1.5 Z.Bianca
BG13	BG001300	NR	Ghiera autobloccante ribassata CI 6 GUK 30 x 1.5 Z.Bianca	Self-locking nut lowered CI 6 GUK 30 x 1.5 Z.Bianca
BG14	BG001400	NR	Ghiera autobloccante ribassata CI 6 GUK 45 x 1.5 Z.Bianca	Self-locking nut lowered CI 6 GUK 45 x 1.5 Z.Bianca
BG15	BG001500	NR	Ghiera autobloccante ribassata CI 6 GUK 50 x 1.5 Z.Bianca	Self-locking nut lowered CI 6 GUK 50 x 1.5 Z.Bianca
BG16	BG001600	NR	Ghiera autobloccante ribassata CI 6 GUK 55 x 1.5 Z.Bianca	Self-locking nut lowered CI 6 GUK 55 x 1.5 Z.Bianca
BI1	BI000100	NR	INSERTO ESAGONALE M6	INSERT HEX M6
BI2	BI000200	NR	INSERTO ESAGONALE M5	INSERT HEX M5

POS	Codice	U.M.	 Descrizione	 Description
BR1	BR000100	NR	Grower sez.rett.spigoli vivi pesante UNI 9195 Acc.Molle D 6 Z.D.Bianca	Grower sez.rett. sharp heavy UNI 9195 Acc.Molle D 6 Z.D. white
BR2	BR000200	NR	Rondella Piana DIN 125-A HV100 D 4 Z.Bianca	Plain washer DIN 125-A HV100 D 4 Z. white
BR3	BR000300	NR	Rondella Piana DIN 125-A HV100 D 5 Z.Bianca	Plain washer DIN 125-A HV100 D 5 Z. white
BR4	BR000400	NR	Rondella Piana DIN 125-A HV100 D 6 Z.Bianca	Plain washer DIN 125-A HV100 D 6 Z. white
BR5	BR000500	NR	Rondella Piana DIN 125-A HV100 D 8 Z.Bianca	Plain washer DIN 125-A HV100 D 8 Z. white
BR6	BR000600	NR	Rondella Piana DIN 125-A HV100 D 10 Z.Bianca	Plain washer DIN 125-A HV100 D 10 Z. white
BR7	BR000700	NR	Rondella Piana DIN 125-A HV100 D 12 Z.Bianca	Plain washer DIN 125-A HV100 D 12 Z. white
BR8	BR000800	NR	Rosetta piana fascia larga e=3d DIN 9021 HV100 D 10 x 30 x 2,5 Z.Bianca	Wide band and flat washer DIN 9021 HV100 3d = D 10 x 30 x 2.5 Z white
BR9	BR000900	NR	Rosetta piana fascia larga e=3d DIN 9021 HV100 D 12 x 36 x 2,5 Z.Bianca	Wide band and flat washer DIN 9021 HV100 3d = D 12 x 36 x 2.5 Z white
BR10	BR001000	NR	Rondella x Carpenteria DIN 6916 HV 300 D 16 Z.Bianca	Carpentry washer DIN 6916 HV 300 D 16 Z white
BR11	BR001100	NR	Rosette speciali HV100 D 25 x 51 x 1 Z.Bianca	Special washers HV100 D 25 x 51 x 1 Z. white
BR13	BR001300	NR	Rondella dentellatura esterna DIN 6798-A Acc.Molle D 3 Z.D.Bianca	Washer external serration DIN 6798-A Acc.Molle D 3 ZD white
BR14	BR001400	NR	Rosetta piana fascia larga e=3d DIN 9021 HV100 D 5 x 15 x 1,2 Z.Bianca	Wide band and flat washer DIN 9021 HV100 3d = D 5 x 15 x 1.2 Z whit
BR15	BR001500	NR	Rosetta piana fascia larga e=3d DIN 9021 HV100 D 6 x 18 x 1,5 Z.Bianca	Wide band and flat washer DIN 9021 HV100 3d = D 6 x 18 x 1.5 Z white
BR16	BR001600	NR	Rosetta piana fascia larga e=3d DIN 9021 HV100 D 8 x 24 x 2 Z.Bianca	Wide band and flat washer DIN 9021 HV100 3d = D 8 x 24 x 2 Z. white
BR17	BR001700	NR	Rosetta piana fascia larga e=3d DIN 9021 HV100 D 4 x 12 x 1 Z.Bianca	Wide band and flat washer DIN 9021 HV100 D = 3d 4 x 12 x 1 Z. white

POS	Codice	U.M.	 Descrizione	 Description
BR18	BR001800	NR	Rondella Piana DIN 125-A NYLON D 4	Plain washer DIN 125-A NYLON D 4
BR19	BR001900	NR	Rondella Piana DIN 125-A HV100 D 3 Z.Bianca	Plain washer DIN 125-A HV100 D 3 Z. white
BR20	BR002000	NR	Rondella Piana DIN 125-A HV100 D 16 Z.Bianca	Plain washer DIN 125-A HV100 D 16 Z. white
BR21	BR002100	NR	Rosetta piana fascia larga e=3d DIN 9021 HV100 D 16 x 48 x 4 Z.Bianca	Wide band and flat washer DIN 9021 HV100 3d = D 16 x 48 x 4 Z. white
BR22	BR002200	NR	Grower sez.rett.spigoli vivi pesante UNI 9195 Acc.Molle D 8 Z.D.Bianca	Grower section. rect. sharp heavy UNI 9195 Stainless Springs D 8 Z.D. white
BR23	BR002300	NR	Rosetta piana fascia larga e=3d DIN 9021 HV100 D 3 x 12 x 1 Z.Bianca	Wide band and flat washer DIN 9021 HV100 D = 3d 3 x 12 x 1 Z. white
BR24	BR002400	NR	Rosetta piana fascia larga e=3d DIN 9021 HV100 D 14 x 42 x 3 Z.Bianca	Wide band and flat washer DIN 9021 HV100 D = 3d 14 x 42 x 3 Z. white
BR25	BR002500	NR	Grower sez.rett.spigoli vivi pesante UNI 9195 Acc.Molle D 10 Z.D.Bianca	Grower sez.rett. sharp heavy UNI 9195 Acc.Molle D 10 Z.D. white
BR26	BR002600	NR	Rondella Piana DIN 125-A D 30 Z.Bianca	Plain washer DIN 125-A D 30 Z. white
BR27	BR002700	NR	Rondella Piana DIN 125-A HV100 D 14 Z.Bianca	Plain washer DIN 125-A HV100 D 14 Z. white
BR28	BR002800	NR	Rosetta piana fascia larga D 6 x 24 x 2 Z.Bianca	Wide band and flat washer D 6 x 24 x 2 Z white
BR29	BR002900	NR	Rondella Piana DIN 125-A HV100 D 18 Z.Bianca	Plain washer DIN 125-A HV100 D 18 Z. white
BR30	BR003000	NR	Rondella Piana DIN 125-A HV100 D 20 Z.Bianca	Plain washer DIN 125-A HV100 D 20 Z. white
BR31	BR003100	NR	Grower sez.rett.spigoli vivi pesante UNI 9195 Acc.Molle D 12 Z.D.Bianca	Grower sez.rett. sharp heavy UNI 9195 Acc.Molle D 12 Z.D. white
BR32	BR003200	NR	Rosette speciali HV100 D 30 x 42 x 0.5 Z.Bianca	Special washers HV100 D 30 x 42 x 0.5 Z. white
BR33	BR003300	NR	Rosette speciali HV100 D 30 x 61 x 1 Z.Bianca	Special washers HV100 D 30 x 61 x 1 Z. white
BR34	BR003400	NR	Rosette speciali HV100 D 42 x 52 x 0.2 Z.Bianca	Special washers HV100 D 42 x 52 x 0.2 Z. white

POS	Codice	U.M.	 Descrizione	 Description
BR35	BR003500	NR	Rosette speciali HV100 D 42 x 52 x 0.3 Z.Bianca	Special washers HV100 D 42 x 52 x 0.3 Z. white
BR36	BR003600	NR	Rosette speciali HV100 D 42 x 52 x 1 Z.Bianca	Special washers HV100 D 42 x 52 x 1 Z. white
BR37	BR003700	NR	Rosette speciali HV100 D 42 x 52 x 1.5 Z.Bianca	Special washers HV100 D 42 x 52 x 1.5 Z. white
BR38	BR003800	NR	Rosette speciali HV100 D 42 x 52 x 2 Z.Bianca	Special washers HV100 D 42 x 52 x 2 Z. white
BR39	BR003900	NR	Rosetta piana fascia larga e=3d DIN 9021 HV100 D 18 x 48 x 4 Z.Bianca	Wide band and flat washer DIN 9021 HV100 3d = D 18 x 48 x 4 Z. white
BR40	BR004000	NR	Rosetta SCHNORR zincate D 6	washer SCHNORR galvanized D 6
BR41	BR004100	NR	Grower sez.rett.spigoli vivi pesante UNI 9195 Acc.Molle D 14 Z.D.Bianca	Grower sez.rett. sharp heavy UNI 9195 Acc.Molle D 14 Z.D. white
BR42	BR004200	NR	Rondella x Carpenteria DIN 6916 HV 300 D 14 Z.Bianca	Carpentry washer DIN 6916 HV 300 D 14 Z white
BS1	BS000100	NR	GRANO FILETTATO M6X12	WHEAT THREAD M6X12
BS2	BS000200	NR	SPINA CIL. 8x16 UNI 6364-A h6 CMT + TMP	PIN CYLINDER 8 x 16 UNI 6364-A CMT h6 + TMP
BS3	BS000300	NR	PRIGIONIERO M10X35	STUD M10X35
BV1	BV000100	NR	Vite TE Parziale Filetto PG DIN 931 CI 8.8 M 8 x 80 Z.Bianca	Screw Partial Thread DIN 931 PG CI 8.8 M 8 x 80 Z. white
BV2	BV000200	NR	Vite TE Tutto Filetto PG DIN 933 CI 8.8 M 8 x 60 Z.Bianca	Screw All Thread DIN 933 PG CI 8.8 M 8 x 60 Z. white
BV3	BV000300	NR	Vite TCEI PG DIN 912 CI 8.8 M 8 x 60 Z.Bianca	Screw DIN 912 PG CI 8.8 M8 x 60 Z. white
BV4	BV000400	NR	Vite TE Parziale Filetto PG DIN 931 CI 8.8 M 8 x 50 Z.Bianca	Screw Partial Thread DIN 931 PG CI 8.8 M 8 x 50 Z. white
BV5	BV000500	NR	Vite TCEI PG DIN 912 CI 8.8 M 8 x 45 Z.Bianca	Screw DIN 912 PG CI 8.8 M8 x 45 Z. white
BV6	BV000600	NR	Vite TCEI PG DIN 912 CI 8.8 M 8 x 40 Z.Bianca	Screw DIN 912 PG CI 8.8 M8 x 40 Z.Bianca

POS	Codice	U.M.	 Descrizione	 Description
BV7	BV000700	NR	Vite TE Tutto Filetto PG DIN 933 CI 8.8 M 8 x 35 Z.Bianca	Screw All Thread DIN 933 PG CI 8.8 M 8 x 35 Z. white
BV8	BV000800	NR	Vite TE Tutto Filetto PG DIN 933 CI 8.8 M 8 x 30 Z.Bianca	Screw All Thread DIN 933 PG CI 8.8 M 8 x 30 Z. white
BV9	BV000900	NR	Vite TE Tutto Filetto PG DIN 933 CI 8.8 M 8 x 25 Z.Bianca	Screw All Thread DIN 933 PG CI 8.8 M 8 x 25 Z. white
BV10	BV001000	NR	Vite TCEI PG DIN 912 CI 8.8 M 8 x 25 Z.Bianca	Screw DIN 912 PG CI 8.8 M8 x 25 Z. white
BV11	BV001100	NR	Vite TE Tutto Filetto PG DIN 933 CI 8.8 M 8 x 20 Z.Bianca	Screw All Thread DIN 933 PG CI 8.8 M 8 x 20 Z. white
BV12	BV001200	NR	Vite TE Tutto Filetto PG DIN 933 CI 8.8 M 8 x 16 Z.Bianca	Screw All Thread DIN 933 PG CI 8.8 M 8 x 16 Z. white
BV13	BV001300	NR	Vite TCEI PG DIN 912 CI 8.8 M 8 x 16 Z.Bianca	Screw DIN 912 PG CI 8.8 M8 x 16 Z. white
BV14	BV001400	NR	Vite TE Tutto Filetto PG DIN 933 CI 8.8 M 8 x 14 Z.Bianca	Screw All Thread DIN 933 PG CI 8.8 M 8 x 14 Z. white
BV15	BV001500	NR	Vite TCEI PG DIN 912 CI 8.8 M 6 x 45 Z.Bianca	Screw DIN 912 M6 x 45 CI 8.8 Z. white
BV16	BV001600	NR	Vite TCEI PG DIN 912 CI 8.8 M 6 x 30 Z.Bianca	Screw DIN 912 M6 x 30 CI 8.8 Z. white
BV17	BV001700	NR	Vite TSPEI PG DIN 7991 CI 10.9 M 6 x 30 Z.Bianca	screw DIN 7991 CI 10.9 M 6 x 30 Z. white
BV18	BV001800	NR	Vite TE Tutto Filetto PG DIN 933 CI 8.8 M 6 x 30 Z.Bianca	Screw All Thread DIN 933 PG CI 8.8 M 6 x 30 Z. white
BV19	BV001900	NR	Vite TBEI PG ISO 7380 CI 10.9 M 6 x 30 Z.Bianca	screw ISO 7380 CI 10.9 M 6 x 30 Z. white
BV20	BV002000	NR	Vite TE Tutto Filetto PG DIN 933 CI 8.8 M 6 x 12 Z.Bianca	Screw All Thread DIN 933 PG CI 8.8 M 6 x 12 Z. white
BV21	BV002100	NR	Vite TCEI PG DIN 912 CI 8.8 M 6 x 12 Z.Bianca	Screw DIN 912 PG CI 8.8 M 6 x 12 Z. white
BV22	BV002200	NR	Vite TCEI PG DIN 912 CI 8.8 M 5 x 45 Z.Bianca	Screw DIN 912 PG CI 8.8 M 5 x 45 Z. white
BV23	BV002300	NR	Vite TE UNF ANSI B18.2.1 GR.5 5/16 x 1" Z.Bianca	Screw UNF ANSI B18.2.1 GR.5 5/16 x 1 "Z. White
BV24	BV002400	NR	Vite TC Croce PG DIN 7985 CI 4.8 M 4 x 8 Z.Bianca	Cross head screw DIN 7985 PG CI 4.8 M 4 x 8 Z. white

POS	Codice	U.M.	 Descrizione	 Description
BV25	BV002500	NR	Vite TCEI PG DIN 912 CI 8.8 M 4 x 16 Z.Bianca	Screw DIN 912 PG CI 8.8 M 4 x 16 Z. white
BV26	BV002600	NR	Vite TCEI PG DIN 912 CI 8.8 M 6 x 50 Z.Bianca	Screw DIN 912 PG CI 8.8 M 6 x 50 Z. white
BV27	BV002700	NR	Vite TSPEI PG DIN 7991 CI 10.9 M 6 x 40 Z.Bianca	screw DIN 7991 CI 10.9 M 6 x 40 Z. white
BV28	BV002800	NR	Vite TSPEI PG DIN 7991 CI 10.9 M 6 x 25 Z.Bianca	screw DIN 7991 CI 10.9 M 6 x 25 Z. white
BV29	BV002900	NR	Vite TE Tutto Filetto PG DIN 933 CI 8.8 M 6 x 25 Z.Bianca	Screw All Thread DIN 933 PG CI 8.8 M 6 x 25 Z. white
BV30	BV003000	NR	Vite TE Tutto Filetto PG DIN 933 CI 8.8 M 6 x 22 Z.Bianca	Screw All Thread DIN 933 PG CI 8.8 M 6 x 22 Z. white
BV31	BV003100	NR	Vite TSPEI PG DIN 7991 CI 10.9 M 6 x 20 Z.Bianca	screw DIN 7991 CI 10.9 M 6 x 20 Z. white
BV32	BV003200	NR	Vite TE Tutto Filetto PG DIN 933 CI 8.8 M 6 x 20 Z.Bianca	Screw All Thread DIN 933 PG CI 8.8 M 6 x 20 Z. white
BV33	BV003300	NR	Vite TCEI PG DIN 912 CI 8.8 M 6 x 20 Z.Bianca	Screw DIN 912 PG CI 8.8 M 6 x 20 Z. white
BV34	BV003400	NR	Vite TE Tutto Filetto PG DIN 933 CI 8.8 M 6 x 16 Z.Bianca	Screw All Thread DIN 933 PG CI 8.8 M 6 x 16 Z. white
BV35	BV003500	NR	Vite TBEI PG ISO 7380 CI 10.9 M 6 x 16 Z.Bianca	screw ISO 7380 CI 10.9 M 6 x 16 Z. white
BV36	BV003600	NR	Vite TCEI PG DIN 912 CI 8.8 M 5 x 8 Z.Bianca	Screw DIN 912 PG CI 8.8 M 5 x 8 Z. white
BV37	BV003700	NR	Vite TSPEI PG DIN 7991 CI 10.9 M 5 x 60 Z.Bianca	screw DIN 7991 CI 10.9 M 5 x 60 Z. white
BV38	BV003800	NR	Vite TE Parziale Filetto PG DIN 931 CI 8.8 M 5 x 60 Z.Bianca	Screw Partial Thread DIN 931 PG CI 8.8 M 5 x 60 Z. white
BV39	BV003900	NR	Vite TCEI PG DIN 912 CI 8.8 M 5 x 60 Z.Bianca	Screw DIN 912 PG CI 8.8 M 5 x 60 Z. white
BV40	BV004000	NR	Vite TE Parziale Filetto PG DIN 931 CI 8.8 M 5 x 55 Z.Bianca	Screw Partial Thread DIN 931 PG CI 8.8 M 5 x 55 Z. white
BV41	BV004100	NR	Vite TE Tutto Filetto PG DIN 933 CI 8.8 M 5 x 16 Z.Bianca	Screw All Thread DIN 933 PG CI 8.8 M 5 x 16 Z. white
BV42	BV004200	NR	Vite TC Croce PG DIN 7985 CI 4.8 M 5 x 16 Z.Bianca	Cross head screw DIN 7985 PG CI 4.8 M 5 x 16 Z. white

POS	Codice	U.M.	 Descrizione	 Description
BV43	BV004300	NR	Vite TE Tutto Filetto PG DIN 933 CI 8.8 M 5 x 12 Z.Bianca	Screw All Thread DIN 933 PG CI 8.8 M 5 x 12 Z. white
BV44	BV004400	NR	Vite TE UNF ANSI B18.2.1 GR.5 5/16 x 1"1/4 Z.Bianca	Screw UNF ANSI B18.2.1 GR.5 5/16 x 1 "1/4 Z. White
BV45	BV004500	NR	Vite TE UNF ANSI B18.2.1 GR.5 5/16 x 1"1/4 Z.Bianca	Screw UNF ANSI B18.2.1 GR.5 5/16 x 1 "1/4 Z. White
BV46	BV004600	NR	Vite TCEI PG DIN 912 CI 8.8 M 4 x 40 Z.Bianca	Screw DIN 912 PG CI 8.8 M 4 x 40 Z. white
BV47	BV004700	NR	Vite Trilob. Autoform. TC Croce PG DIN 7500-C C15 M 4 x 40 Z.Bianca	Trilob Screw. Autoform. TC Cross PH DIN 7500-C C 15 M 4 x 40 Z. white
BV48	BV004800	NR	Vite Trilob. Autoform. TC Croce PG DIN 7500-C C15 M 4 x 20 Z.Bianca	Trilob Screw. Autoform. TC Cross PG DIN 7500-C C15 M 4 x 20 Z. white
BV49	BV004900	NR	Vite TC Croce PG DIN 7985 CI 4.8 M 4 x 16 Z.Bianca	Cross head screw DIN 7985 PG CI 4.8 M 4 x 16 Z. white
BV50	BV005000	NR	VITE AUTOFIETTANTE TE C/BORDINO DIN 6928 C15 4,8X50 Z.Bianca	TAPPING SCREW TE C / BORDINO DIN 6928 C15 4.8 X50 Z. white
BV51	BV005100	NR	VITE AUTOFIETTANTE TE C/BORDINO DIN 6928 C15 4,8X25 Z.Bianca	TAPPING SCREW TE C / BORDINO DIN 6928 C15 4.8 X25 Z. white
BV52	BV005200	NR	Vite TCEI PG DIN 912 CI 12.9 M 3 x 25 Z.D.Bianca	Screw DIN 912 M 3 CI 12.9 x 25 Z.D. white
BV53	BV005300	NR	Vite TSPEI PG DIN 7991 CI 10.9 M 3 x 14 Z.Bianca	Screw DIN 7991 CI 10.9 M 3 x 14 Z. white
BV54	BV005400	NR	Vite Autofil.TC Croce DIN 7981 C15 3,5 x 6,5 Z.Bianca	Autofil.TC Cross Screw DIN 7981 C15 3.5 x 6.5 Z. white
BV55	BV005500	NR	Vite TE Parziale Filetto PG DIN 931 CI 10.9 M 16 x 55 Z.D.Bianca	Screw Partial Thread DIN 931 PG CI 10.9 M 16 x 55 ZD white
BV56	BV005600	NR	Vite TE Tutto Filetto PG DIN 933 CI 8.8 M 16 x 40 Z.Bianca	Screw All Thread DIN 933 PG CI 8.8 M 16 x 40 Z. white
BV57	BV005700	NR	Vite TE Parziale Filetto PG DIN 931 CI 10.9 M 16 x 220 Z.Deidro Bianche	Screw Partial Thread DIN 931 PG CI 10.9 M 16 x 220 Z. dehydro White
BV58	BV005800	NR	Vite TE 8.8 DIN933 M16x20 Testa Alta 8 Zn Bianca	Screw M16x20 DIN933 8.8 Head High 8 Zn White
BV59	BV005900	NR	Vite TE Tutto Filetto PG DIN 933 CI 8.8 M 12 x 16 Z.Bianca	Screw All Thread DIN 933 PG CI 8.8 M 12 x 16 Z. white

POS	Codice	U.M.	 Descrizione	 Description
BV60	BV006000	NR	Vite TE Parziale Filetto PG DIN 931 CI 8.8 M 12 x 120 Z.Bianca	Screw Partial Thread DIN 931 PG CI 8.8 M 12 x 120 Z. white
BV61	BV006100	NR	Vite TE Parziale Filetto PG DIN 931 CI 8.8 M 10 x 50 Z.Bianca	Screw Partial Thread DIN 931 PG CI 8.8 M 10 x 50 Z. white
BV62	BV006200	NR	Vite TE Tutto Filetto PG DIN 933 CI 8.8 M 10 x 35 Z.Bianca	Screw All Thread DIN 933 PG CI 8.8 M 10 x 35 Z. white
BV63	BV006300	NR	Vite TSPEI PG DIN 7991 CI 10.9 M 10 x 30 Z.Bianca	Screw DIN 7991 CI 10.9 M 10 x 30 Z. white
BV64	BV006400	NR	Vite TE Tutto Filetto PG DIN 933 CI 8.8 M 10 x 30 Z.Bianca	Screw All Thread DIN 933 PG CI 8.8 M 10 x 30 Z. white
BV65	BV006500	NR	Vite TCEI PG DIN 912 CI 12.9 M 10 x 25 Geo 321 A	Screw DIN 912 PG CI 12.9 M 10 x 25 Geo 321 A
BV66	BV006600	NR	Vite TCEI PG DIN 912 CI 8.8 M 10 x 25 Z.Bianca	Screw DIN 912 PG CI 8.8 M 10 x 25 Z. white
BV67	BV006700	NR	Vite TE Tutto Filetto PG DIN 933 CI 8.8 M 10 x 20 Z.Bianca	Screw All Thread DIN 933 PG CI 8.8 M 10 x 20 Z. white
BV68	BV006800	NR	Vite TE Tutto Filetto PG DIN 933 CI 8.8 M 10 x 18 Z.Bianca	Screw All Thread DIN 933 PG CI 8.8 M 10 x 18 Z. white
BV69	BV006900	NR	Vite Trilob. Autoform. TSP Croce PG DIN 7500-M C15 M 5 x 16 Z.Bianca	Trilob Screw. Autoform. TSP Cross PG DIN 7500-M C15 M 5 x 16 Z. white
BV70	BV007000	NR	Vite TE Parziale Filetto PG DIN 931 CI 8.8 M 8 x 70 Z.Bianca	Screw Partial Thread DIN 931 PG CI 8.8 M 8 x 70 Z. white
BV71	BV007100	NR	Vite TE Parziale Filetto PG DIN 931 CI 8.8 M 8 x 65 Z.Bianca	Screw Partial Thread DIN 931 PG CI 8.8 M 8 x 65 Z. white
BV72	BV007200	NR	Vite TE Parziale Filetto PG DIN 931 CI 8.8 M 6 x 55 Z.Bianca	Screw Partial Thread DIN 931 PG CI 8.8 M 6 x 55 Z. white
BV73	BV007300	NR	Vite TCEI PG DIN 912 CI 8.8 M 6 x 55 Z.Bianca	Screw DIN 912 PG CI 8.8 M 6 x 55 Z. white
BV74	BV007400	NR	Vite TCEI PG DIN 912 CI 8.8 M 6 x 16 Z.Bianca	Screw DIN 912 PG CI 8.8 M 6 x 16 Z. white
BV75	BV007500	NR	Vite TSPEI PG DIN 7991 CI 10.9 M 6 x 10 Z.Bianca	Screw DIN 7991 CI 10.9 M 6 x 10 Z. white
BV76	BV007600	NR	Vite TCEI PG DIN 912 CI 8.8 M 5 x 55 Z.Bianca	Screw DIN 912 PG CI 8.8 M 5 x 55 Z. white



POS	Codice	U.M.	 Descrizione	 Description
BV77	BV007700	NR	Vite TC Croce PG DIN 7985 CI 4.8 M 6 x 16 Z.Bianca	Cross head screw DIN 7985 PG CI 4.8 M 6 x 16 Z. white
BV78	BV007800	NR	Vite Trilob. Autoform. TC Croce PG DIN 7500-C C15 M 5 x 12 Z.Bianca	Trilob Screw. Autoform. TC Cross PG DIN 7500-C C15 M 5 x 12 Z. white
BV79	BV007900	NR	Vite TE Tutto Filetto PG DIN 933 CI 8.8 M 4 x 35 Z.Bianca	Screw All Thread DIN 933 PG CI 8.8 M 4 x 35 Z. white
BV80	BV008000	NR	VITE AUTOFIETTANTE TE C/BORDINO DIN 6928 C15 4,8X35 Z.Bianca	TAPPING SCREW TE C / BORDINO DIN 6928 C15 4.8 X35 Z. white
BV81	BV008100	NR	Vite TCEI PG DIN 912 CI 12.9 M 3 x 14 Z.D.Bianca	Screw DIN 912 M 3 CI 12.9 x 14 Z.D. white
BV82	BV008200	NR	Vite TE Parziale Filetto PG DIN 931 CI 8.8 M 16 x 70 Z.Bianca	Screw Partial Thread DIN 931 PG CI 8.8 M 16 x 70 Z. white
BV83	BV008300	NR	Vite TE Parziale Filetto PG DIN 931 CI 8.8 M 16 x 260 Z.Bianca	Screw Partial Thread DIN 931 PG CI 8.8 M 16 x 260 Z. white
BV84	BV008400	NR	Vite TE Parziale Filetto PG DIN 931 CI 8.8 M 12 x 110 Z.Bianca	Screw Partial Thread DIN 931 PG CI 8.8 M 12 x 110 Z. white
BV85	BV008500	NR	Vite TE Tutto Filetto PG DIN 933 CI 8.8 M 10 x 40 Z.Bianca	Screw Thread DIN 933 PG CI 8.8 M 10 x 40 Z. white
BV86	BV008600	NR	Vite TCEI PG DIN 912 CI 8.8 M 8 x 65 Z.Bianca	Screw DIN 912 PG CI 8.8 M 8 x 65 Z. white
BV87	BV008700	NR	Vite TCEI PG DIN 912 CI 8.8 M 8 x 20 Z.Bianca	Screw DIN 931 PG CI 8.8 M 10 x 40 Z. white
BV88	BV008800	NR	Vite TCEI PG DIN 912 CI 10.9 M 10 x 18 Z.Bianca	Screw DIN 912 PG CI 10.9 M 10 x 18 Z. white
BV89	BV008900	NR	Vite TCEI PG DIN 912 CI 8.8 M 8 x 70 Z.Bianca	Screw DIN 912 PG CI 8.8 M 8 x 70 Z. white
BV91	BV009100	NR	Vite TE Tutto Filetto PG DIN 933 CI 8.8 M 6 x 40 Z.Bianca	Screw All Thread DIN 933 PG CI 8.8 M 6 x 40 Z. white
BV92	BV009200	NR	Vite TE Tutto Filetto PG DIN 933 CI 8.8 M 10 x 60 Z.Bianca	Screw All Thread DIN 933 PG CI 8.8 M 10 x 60 Z. white
BV93	BV009300	NR	Vite TSPEI PG DIN 7991 CI 10.9 M 5 x 20 Z.Bianca	screw DIN 7991 CI 10.9 M 5 x 20 Z. white
BV94	BV009400	NR	Vite TC Croce PG DIN 7985 CI 4.8 M 4 x 12 Z.Bianca	Cross head screw DIN 7985 PG CI 4.8 M 4 x 12 Z. white

POS	Codice	U.M.	 Descrizione	 Description
BV95	BV009500	NR	Vite TE Tutto Filetto PG DIN 933 CI 8.8 M 4 x 12 Z.Bianca	Screw All Thread DIN 933 PG CI 8.8 M 4 x 12 Z. white
BV96	BV009600	NR	Vite TCEI PG DIN 912 CI 12.9 M 12 x 30 Dac 320A	Screw DIN 912 CI 12.9 M 12 x 30 Dac 320A
BV97	BV009700	NR	Vite Autofil. Testa Mezza Tonda C15 4,8 x 13 Z.Bianca	Half Round Head Self Tapping Screw C15 4,8 x 13
BV98	BV009800	NR	Vite TC Croce PG DIN 7985 CI 4.8 M 4 x 12 Z.Bianca	Screw DIN 7985 CI 4.8 M 4 x 12
BV99	BV009900	NR	Vite TE Parziale Filetto PG DIN 931 CI 8.8 M 5 x 65 Z.Bianca	Screw Partial Thread DIN 931 PG CI 8.8 M 5 x 65 Z. white
BV100	BV010000	NR	Vite Autofil. Testa Mezza Tonda C15 4,8 x 16 Z.Bianca	Half Round Head Self Tapping Screw C15 4,8 x 16
BV101	BV010100	NR	Vite TSPEI PG DIN 7991 CI 10.9 M 8 x 25 Z.Bianca	screw DIN 7991 CI 10.9 M 8 x 25 Z. white
BV102	BV010200	NR	Vite TCEI PG DIN 912 CI 8.8 M 4 x 30 Z.Bianca	Screw DIN 912 PG CI 8.8 M 4 x 30 White Z
BV103	BV010300	NR	Vite TSPEI PG DIN 7991 CI 10.9 M 5 x 16 Z.Bianca	Screw DIN 7991 CI 10.9 M 5 x 16 Z. white
BV104	BV010400	NR	Vite TCEI bassa PG DIN 7984 CI 10.9 M 12 x 18 Z.D.Bianca	Screw DIN 7984 low PG CI 10.9 M 12 x 18 Z. D. white
BV105	BV010500	NR	Vite TE Parziale Filetto PG DIN 931 CI 8.8 M 12 x 75 Z.Bianca	Screw Partial Thread DIN 931 PG CI 8.8 M 12 x 75 Z. white
BV106	BV010600	NR	Vite TE Tutto Filetto PG DIN 933 CI 8.8 M 8 x 22 Z.Bianca	Screw All Thread DIN 933 PG CI 8.8 M 8 x 22 Z. white
BV107	BV010700	NR	Vite TE Tutto Filetto PG DIN 933 CI 8.8 M 6 x 35 Z.Bianca	Screw All Thread DIN 933 PG CI 8.8 M 6 x 35 Z. white
BV108	BV010800	NR	Vite TE Parziale Filetto PG DIN 931 CI 8.8 M 4 x 45 Z.Bianca	Screw Partial Thread DIN 931 PG CI 8.8 M 4 x 45 Z. white
BV109	BV010900	NR	Vite TE Tutto Filetto PG DIN 933 CI 10.9 M 16 x 45 Z.D.Bianca	Screw All Thread DIN 933 PG CI 10.9 M 16 x 45 ZD white
BV110	BV011000	NR	Vite TE Parziale Filetto PG DIN 931 CI 10.9 M 16 x 100 Z.D.Bianca	Screw Partial Thread DIN 931 PG CI 10.9 M 16 x 100 ZD white
BV111	BV011100	NR	Vite TE Parziale Filetto PG DIN 931 CI 10.9 M 16 x 105 Z.D.Bianca	Screw Partial Thread DIN 931 PG CI 10.9 M 16 x 105 ZD white

POS	Codice	U.M.	 Descrizione	 Description
BV112	BV011200	NR	Vite TE Tutto Filetto PG DIN 933 CI 8.8 M 10 x 25 Z.Bianca	Screw All Thread DIN 933 PG CI 8.8 M 10 x 25 Z. white
BV113	BV011300	NR	Vite TSPEI PG DIN 7991 CI 10.9 M 6 x 50 Z.Bianca	TSPEI PG screw DIN 7991 CI 10.9 M 6 x 50 Z. white
BV114	BV011400	NR	Vite TSPEI PG DIN 7991 CI 10.9 M 8 x 25 Z.Bianca	TSPEI PG screw DIN 7991 CI 10.9 M 8 x 25 Z. white
BV115	BV011500	NR	Vite TE Tutto Filetto PG DIN 933 CI 8.8 M 10 x 45 Z.Bianca	Screw All Thread DIN 933 PG CI 8.8 M 10 x 45 Z. white
BV116	BV011600	NR	Vite TE Tutto Filetto PG DIN 933 CI 8.8 M 5 x 8 Z.Bianca	Screw All Thread DIN 933 PG CI 8.8 M 5 x 8 Z. white
BV117	BV011700	NR	Vite TE Tutto Filetto PG DIN 933 CI 8.8 M 8 x 18 Z.Bianca	Screw All Thread DIN 933 PG CI 8.8 M 8 x 18 Z. white
BV118	BV011800	NR	Vite TE Tutto Filetto PG DIN 933 CI 8.8 M 8 x 40 Z.Bianca	Screw All Thread DIN 933 PG CI 8.8 M 8 x 40 Z. white
BV119	BV011900	NR	Vite TCEI PG DIN 912 CI 8.8 M 8 x 100 Z.Bianca	Screw DIN 912 PG CI 8.8 M 8 x 100 Z. white
BV120	BV012000	NR	Vite TCEI PG DIN 912 CI 8.8 M 8 x 110 Z.Bianca	Screw DIN 912 PG CI 8.8 M 8 x 110 Z. white
BV121	BV012100	NR	Vite TE Parziale Filetto PG DIN 931 CI 8.8 M 5 x 75 Z.Bianca	Screw Partial Thread DIN 931 PG CI 8.8 M 5 x 75 Z. white
BV122	BV012200	NR	Vite TE Parziale Filetto PG DIN 931 CI 8.8 M 12 x 130 Z.Bianca	Screw Partial Thread DIN 931 PG CI 8.8 M 12 x 130 Z. white
BV123	BV012300	NR	Vite TC Croce PG DIN 7985 CI 4.8 M 4 x 8 Z.Bianca	Cross head screw DIN 7985 PG CI 4.8 M 4 x 8 Z. white
BV124	BV012400	NR	Vite TCEI PG DIN 912 CI 8.8 M 6 x 40 Z.Bianca	Screw DIN 912 PG CI 8.8 M 6 x 40 Z. white
BV125	BV012500	NR	Vite TE Tutto Filetto PG DIN 933 CI 8.8 M 4 x 20 Z.Bianca	Screw All Thread DIN 933 PG CI 8.8 M 4 x 20 Z. white
BV126	BV012600	NR	Vite TE UNC ANSI B18.2.1 GR.5 3/8 x 1" Z.Bianca	Screw UNC ANSI B18.2.1 GR.5 3/8 x 1" Z. White
BV127	BV012700	NR	Vite TE UNC ANSI B18.2.1 GR.5 3/8 x 1" 1/4Z.Bianca	Screw UNC ANSI B18.2.1 GR.5 3/8 x 1" 1/4 Z. White
BV128	BV012800	NR	Vite TE Tutto Filetto PG DIN 933 CI 8.8 M 4 x 16 Z.Bianca	Screw All Thread DIN 933 PG CI 8.8 M 4 x 16 Z. white
BV129	BV012900	NR	Vite TCEI PG DIN 912 CI 8.8 M 5 x 16 Z.Bianca	Screw DIN 912 PG CI 8.8 M 5 x 16 Z. white

POS	Codice	U.M.	 Descrizione	 Description
BV130	BV013000	NR	Vite TCEI PG DIN 912 CI 8.8 M 3 x 12 Z.Bianca	Screw DIN 912 PG CI 8.8 M 3 x 12 Z. white
BV131	BV013100	NR	Vite TSPEI PG DIN 7991 CI 10.9 M 5 x 30 Z.Bianca	TSPEI PG screw DIN 7991 CI 10.9 M 5 x 30 Z. white
BV132	BV013200	NR	Vite TSPEI PG DIN 7991 CI 10.9 M 5 x 55 Z.Bianca	TSPEI PG screw DIN 7991 CI 10.9 M 5 x 55 Z. white
BV133	BV013300	NR	Vite TE Tutto Filetto PG DIN 933 CI 8.8 M 3 x 25 Z.Bianca	Screw All Thread DIN 933 PG CI 8.8 M 3 x 25 Z. white
BV134	BV013400	NR	Vite TE Parziale Filetto PG DIN 931 CI 8.8 M 10 x 65 Z.Bianca	Screw Partial Thread DIN 931 PG CI 8.8 M 10 x 65 Z. white
BV135	BV013500	NR	Vite TCEI PG DIN 912 CI 8.8 M 12 x 50	Screw DIN 912 CI 8.8 M 12 x 50
BV136	BV013600	NR	Vite TSPEI PG DIN 7991 CI 10.9 M 5 x 25 Z.Bianca	TSPEI PG screw DIN 7991 CI 10.9 M 5 x 25 Z. white
BV137	BV013700	NR	Vite TCEI PG DIN 912 CI 8.8 M 8 x 30	Screw DIN 912 CI 8.8 M 8 x 30
BV138	BV013800	NR	Vite TC Croce PG DIN 7985 CI 4.8 M 5 x 10 Z.Bianca	Screw DIN 7985 CI 4.8 M 5 x 10
BV139	BV013900	NR	Vite TCEI PG DIN 912 CI 12.9 M 4 x 25 Z. Bianca	Screw DIN 912 CI 12.9 M 4 x 25 Z. Withe
BV140	BV014000	NR	Vite TE Parziale Filetto PG DIN 931 CI 8.8 M 5 x 70 Z.Bianca	Screw Partial Thread DIN 931 PG CI 8.8 M 5 x 70 Z. white
BV141	BV014100	NR	Vite TE Parziale Filetto PG DIN 931 CI 8.8 M 12 x 90 Z.Bianca	Screw Partial Thread DIN 931 PG CI 8.8 M 12 x 90 Z. white
BV142	BV014200	NR	Vite TE Parziale Filetto PG DIN 931 CI 8.8 M 8 x 55 Z.Bianca	Screw Partial Thread DIN 931 PG CI 8.8 M 8 x 55 Z. white
BV143	BV014300	NR	Vite TSPEI PG DIN 7991 CI 10.9 M 10 x 20 Z.Bianca	TSPEI PG screw DIN 7991 CI 10.9 M 10 x 20 Z. white
BV144	BV014400	NR	Vite TE Tutto Filetto PG DIN 933 CI 8.8 M 12 x 20 Z.Bianca	Screw All Thread DIN 933 PG CI 8.8 M 12 x 20 Z. white
BV145	BV014500	NR	Vite TE Tutto Filetto PG DIN 933 CI 8.8 M 12 x 35 Z.Bianca	Screw All Thread DIN 933 PG CI 8.8 M 12 x 35 Z. white
BV146	BV014600	NR	Vite TE Tutto Filetto PF DIN 961 CI 8.8 M 10 x 1,25 x 25 Z.Bianca	All PF thread hex head screw DIN 961 CI 8.8 M 10 x 1,25 x 25 Z.Bianca



POS	Codice	U.M.	 Descrizione	 Description
BV147	BV014700	NR	Vite TSPEI PG DIN 7991 CI 10.9 M 12 x 90 Z.Bianca	TSPEI PG screw DIN 7991 CI 10.9 M12 x 90 Z. white
BV148	BV014800	NR	Vite TSPEI PG DIN 7991 CI 10.9 M 6 x 16 Z.Bianca	TSPEI PG screw DIN 7991 CI 10.9 M6 x 16 Z. white
BV149	BV014900	NR	Vite TBEI PG ISO 7380 CI 10.9 M 6 x 20 Z.Bianca	Hex socket screw ISO 7380 PG CI 10.9 M 6 x 20 Z. white
BV150	BV015000	NR	Vite TE Tutto Filetto PG DIN 933 CI 10.9 M 14 x 40 Z.Bianca	Screw All Thread DIN 933 PG CI 10.9 M 14 x 40 Z. white
BV151	BV015100	NR	Vite TE Parziale Filetto PG DIN 931 CI 8.8 M 10 x 85 Z.Bianca	Screw Partial Thread DIN 931 PG CI 8.8 M 10 x 85 Z. white
BV152	BV015200	NR	Vite TE Parziale Filetto PG DIN 931 CI 8.8 M 10 x 75 Z.Bianca	Screw Partial Thread DIN 931 PG CI 8.8 M 10 x 75 Z. white
BV153	BV015300	NR	Vite TE Tutto Filetto PG DIN 933 CI 8.8 M14 x 45 Z.Bianca	Screw All Thread DIN 933 PG CI 8.8 M14 x 45 Z. white
BV154	BV015400	NR	Vite TCEI PG DIN 912 CI 12.9 M 8 x 35 GEOMET 321A	Screw DIN 912 CI 12.9 M 8 x 35 GEOMET 321A
BV155	BV015500	NR	Vite TCEI PG DIN 912 CI 12.9 M 5 x 20 GEOMET 321A	Screw DIN 912 CI 12.9 M 5 x 20 GEOMET 321A
BV156	BV015600	NR	Vite TBEI PG ISO 7380 CI 10.9 M 6 x 25 Z.Bianca	Hex socket screw ISO 7380 PG CI 10.9 M 6 x 25 Z. white
BV157	BV015700	NR	Vite TBEI PG ISO 7380 CI 10.9 M 8 x 20 Z.Bianca	Hex socket screw ISO 7380 PG CI 10.9 M 8 x 20 Z. white
BV158	BV015800	NR	Vite TBEI PG ISO 7380 CI 10.9 M 6 x 70 Z.Bianca	Hex socket screw ISO 7380 PG CI 10.9 M 6 x 70 Z. white
BV159	BV015900	NR	Vite TBEI PG ISO 7380 CI 10.9 M 10 x 20 Z.Bianca	Hex socket screw ISO 7380 PG CI 10.9 M 10 x 20 Z. white
BV160	BV016000	NR	Vite TSPEI PG DIN 7991 CI 10.9 M 4 x 16 Z.Bianca	TSPEI PG screw DIN 7991 CI 10.9 M4 x 16 Z. white
BV161	BV016100	NR	Vite TE UNC ANSI B18.2.1 GR.5 1/2 passo 13 L= 1" 1/4	UNC hex head screw ANSI B18.2.1 GR.5 1/2 11 L = 1 "1/4
BV162	BV016200	NR	Vite TCEI PG DIN 912 CI 12.9 M14 x 45 GEOMET 321A	Screw DIN 912 CI 12.9 M14 x 45 GEOMET 321A
BV163	BV016300	NR	Vite TCEI PG DIN 912 CI 8.8 M6 x 35 GEOMET 321A	Screw DIN 912 CI 8.8 M6 x 35 GEOMET 321A

POS	Codice	U.M.	 Descrizione	 Description
BV164	BV016400	NR	Vite TCEI PG DIN 912 CI 8.8 M10 x 35 GEOMET 321A	Screw DIN 912 CI 8.8 M10 x 35 GEOMET 321A
BV165	BV016500	NR	Vite TE Tutto Filetto PG DIN 933 CI 8.8 M8 x 12 Z.Bianca	Screw All Thread DIN 933 PG CI 8.8 M8 x 12 Z. white
BV166	BV016600	NR	Vite TCEI PG DIN 912 CI 8.8 M4 x 20 GEOMET 321A	Screw DIN 912 CI 8.8 M4 x 20 GEOMET 321A
BV167	BV016700	NR	Vite TCEI PG DIN 912 CI 8.8 M4 x 20 GEOMET 321A	All PF thread hex head screw DIN 961 CI 8.8 M 12 x 1,25 x 30 Z.Bianca
BV168	BV016800	NR	Vite TE Tutto Filetto PF DIN 961 CI 8.8 M 10 x 1,25 x 30 Z.Bianca	All PF thread hex head screw DIN 961 CI 8.8 M 10 x 1,25 x 30 Z.Bianca
BV169	BV016900	NR	Vite TCEI PG DIN 912 CI 8.8 M 10 x 1,25 x 30	Screw DIN 912 CI 8.8 M10 x 1,25 x 30
BV170	BV017000	NR	Vite TE Tutto Filetto PF DIN 961 CI 8.8 M 10 x 1,25 x 30 Z.Bianca	All PF thread hex head screw DIN 961 CI 8.8 M 10 x 1,25 x 60 Z.Bianca
BV171	BV017100	NR	Vite TE Tutto Filetto PF DIN 961 CI 8.8 M 12 x 1,25 x 25 Z.Bianca	All PF thread hex head screw DIN 961 CI 8.8 M 12 x 1,25 x 25 Z.Bianca
BV172	BV017200	NR	Vite TE UNC ANSI B18.2.1 GR.5 5/8 passo 11 L= 1" 1/2	UNC hex head screw ANSI B18.2.1 GR.5 5/8 11 L = 1 "1/2
BV173	BV017300	NR	Vite TE Tutto Filetto PG DIN 933 CI 8.8 M12 x 30 Z.Bianca	Screw All Thread DIN 933 PG CI 8.8 M12 x 30 Z. white
BV174	BV017400	NR	Vite TE Tutto Filetto PG DIN 933 CI 8.8 M5 x 45 Z.Bianca	Screw All Thread DIN 933 PG CI 8.8 M5 x 45 Z. white
BV175	BV017500	NR	Vite TE Tutto Filetto PG DIN 933 CI 8.8 M12 x 80 Z.Bianca	Screw All Thread DIN 933 PG CI 8.8 M12 x 80 Z. white
BV176	BV017600	NR	Vite TCEI PG DIN 912 CI 8.8 M6 x 25 GEOMET 321A	Screw DIN 912 CI 8.8 M6 x 25 GEOMET 321A
BV177	BV017700	NR	Vite TE Tutto Filetto PG DIN 933 CI 8.8 M12 x 85 Z.Bianca	Screw All Thread DIN 933 PG CI 8.8 M12 x 85 Z. white
BV178	BV017800	NR	Vite TE Tutto Filetto PG DIN 933 CI 8.8 M8 x 90 Z.Bianca	Screw All Thread DIN 933 PG CI 8.8 M8 x 90 Z. white
BV179	BV017900	NR	Vite TE Tutto Filetto PG DIN 933 CI 8.8 M5 x 40 Z.Bianca	Screw All Thread DIN 933 PG CI 8.8 M5 x 40 Z. white
BV180	BV018000	NR	Vite TE Tutto Filetto PG DIN 933 CI 8.8 M6 x 75 Z.Bianca	Screw All Thread DIN 933 PG CI 8.8 M6 x 75 Z. white



POS	Codice	U.M.	 Descrizione	 Description
BV181	BV018100	NR	Vite TE Tutto Filetto PG DIN 933 CI 8.8 M10 x 40 Z.Bianca	Screw All Thread DIN 933 PG CI 8.8 M10 x 40 Z. white
BV182	BV018200	NR	Vite TE Tutto Filetto PG DIN 933 CI 10.9 M 16 x 70 Z.Bianca	Screw All Thread DIN 933 PG CI 10.9 M 16 x 70 Z. white
BV183	BV018300	NR	Vite TE Tutto Filetto PG DIN 933 CI 8.8 M5 x 10 Z.Bianca	Screw All Thread DIN 933 PG CI 8.8 M5 x 10 Z. white
BV184	BV018400	NR	Vite TE Tutto Filetto PG DIN 933 CI 8.8 M10 x 16 Z.Bianca	Screw All Thread DIN 933 PG CI 8.8 M10 x 16 Z. white
BV185	BV018500	NR	Vite TCEI PG DIN 912 CI 8.8 M8 x 55 GEOMET 321A	Screw DIN 912 CI 8.8 M8 x 55 GEOMET 321A
BV186	BV018600	NR	Vite TCEI PG DIN 912 CI 12.9 M10 x 30 GEOMET 321A	Screw DIN 912 CI 12.9 M10 x 30 GEOMET 321A
BV187	BV018700	NR	Vite TCEI PG DIN 912 CI 12.9 M14 x 40 GEOMET 321A	Screw DIN 912 CI 12.9 M14 x 40 GEOMET 321A
BV188	BV018800	NR	Vite TE Tutto Filetto PG DIN 933 CI 8.8 M 12 x 60 Z.Bianca	Screw All Thread DIN 933 PG CI 8.8 M12 x 60 Z. white
BV189	BV018900	NR	Vite TE Tutto Filetto PG DIN 933 CI 8.8 M 12 x 55 Z.Bianca	Screw All Thread DIN 933 PG CI 8.8 M12 x 55 Z. white
BV190	BV019000	NR	Vite TE Tutto Filetto PG DIN 933 CI 8.8 M 12 x 50 Z.Bianca	Screw All Thread DIN 933 PG CI 8.8 M12 x 50 Z. white
BV191	BV019100	NR	Vite TE Tutto Filetto PG DIN 933 CI 8.8 M 16 x 50 Z.Bianca	Screw All Thread DIN 933 PG CI 8.8 M16 x 50 Z. white
BV192	BV019200	NR	Vite TE Tutto Filetto PG DIN 933 CI 8.8 M 16 x 55 Z.Bianca	Screw All Thread DIN 933 PG CI 8.8 M16 x 55 Z. white
BV193	BV019300	NR	Vite TE Parziale Filetto PG DIN 931 CI 8.8 M 10 x 55 Z.Bianca	Screw Partial Thread DIN 931 PG CI 8.8 M 10 x 55 Z. white
BV194	BV019400	NR	Vite TE Parziale Filetto PG DIN 931 CI 8.8 M 16 x 230 Z.Bianca	Screw Partial Thread DIN 931 PG CI 8.8 M 16 x 230 Z. white
BV195	BV019500	NR	Vite TE Parziale Filetto PG DIN 931 CI 8.8 M 6 x 50 Z.Bianca	Screw Partial Thread DIN 931 PG CI 8.8 M 6 x 50 Z. white
BV196	BV019600	NR	Vite TE Parziale Filetto PG DIN 931 CI 8.8 M 6 x 65 Z.Bianca	Screw Partial Thread DIN 931 PG CI 8.8 M 6 x 65 Z. white
BV197	BV019700	NR	Vite TE Parziale Filetto PG DIN 931 CI 8.8 M 8 x 45 Z.Bianca	Screw Partial Thread DIN 931 PG CI 8.8 M 8 x 45 Z. white



POS	Codice	U.M.	 Descrizione	 Description
BV198	BV019800	NR	Vite TE Parziale Filetto PG DIN 931 CI 8.8 M 8 x 55 Z.Bianca	Screw Partial Thread DIN 931 PG CI 8.8 M 8 x 55 Z. white
BV199	BV019900	NR	Vite TE Parziale Filetto PG DIN 931 CI 8.8 M 8 x 60 Z.Bianca	Screw Partial Thread DIN 931 PG CI 8.8 M 8 x 60 Z. white
BV200	BV020000	NR	Vite TE Tutto Filetto PG DIN 933 CI 10.9 M 16 x 40 Z.Bianca	Screw All Thread DIN 933 PG CI 10.9 M 16 x 40 Z. white
BV201	BV020100	NR	Vite TSPEI PG DIN 7991 CI 10.9 M16 x 45 Z.Bianca	TSPEI PG screw DIN 7991 CI 10.9 M16 x 45 Z. white
BV202	BV020200	NR	Vite TCEI PG DIN 912 CI 12.9 M3 x 12 ZINC. iridescente Fe/Zn5IVs	Screw DIN 912 CI 12.9 M3 x 12 ZINC. iridescente Fe/Zn5IVs
BV203	BV020300	NR	Vite TC Croce PG DIN 7985 CI 4.8 M M 3 x 5 Z.Bianca	Screw DIN 7985 CI 4.8 M M 3 x 5
BV204	BV020400	NR	Vite TC Croce PG DIN 7985 CI 4.8 M M 3 x 8 Z.Bianca	Screw DIN 7985 CI 4.8 M M 3 x 8
BV205	BV020500	NR	Vite TTQST DIN 603/555 CI 4.8 M 8 x 35 Z.Bianca	TTQST Screw DIN 603/555 CL 4.8 M 8 x 35 Z. White
BV206	BV020600	NR	Vite TC Croce PG DIN 7985 CI 4.8 M M 5 x 80 Z.Bianca	Screw DIN 7985 CI 4.8 M M 5 x 80
BV207	BV020700	NR	Vite TE Parziale Filetto PG DIN 931 CI 8.8 M 10 x 80 Z.Bianca	Screw Partial Thread DIN 931 PG CI 8.8 M 10 x 80 Z. white
BV208	BV020800	NR	Vite TE Tutto Filetto PG DIN 933 CI 8.8 M 16 x 35 Z.D.Bianca	Screw All Thread DIN 933 PG CI 8.8 M 16 x 35 ZD white
BV209	BV020900	NR	Vite TE Parziale Filetto PG DIN 931 CI 8.8 M 10 x 95 Z.Bianca	Screw Partial Thread DIN 931 PG CI 8.8 M 10 x 95 Z. white
BV210	BV021000	NR	Vite TE Tutto Filetto PG DIN 933 CI 8.8 M 6 x 14 Z.D.Bianca	Screw All Thread DIN 933 PG CI 8.8 M 6 x 14 ZD white
BV211	BV021100	NR	Vite TE Tutto Filetto PG DIN 933 CI 8.8 M 12 x 25 Z.D.Bianca	Screw All Thread DIN 933 PG CI 8.8 M 12 x 25 ZD white
BV212	BV021200	NR	Vite TE Tutto Filetto PG DIN 933 CI 8.8 M 4 x 14 Z.D.Bianca	Screw All Thread DIN 933 PG CI 8.8 M 4 x 14 ZD white
BV213	BV021300	NR	Vite TE Tutto Filetto PG DIN 933 CI 8.8 M 16 x 60 Z.D.Bianca	Screw All Thread DIN 933 PG CI 8.8 M 16 x 60 ZD white
BV214	BV021400	NR	Vite TE Parziale Filetto PG DIN 931 CI 8.8 M 6 x 100 Z.Bianca	Screw Partial Thread DIN 931 PG CI 8.8 M 6 x 100 Z. white

POS	Codice	U.M.	 Descrizione	 Description
BV215	BV021500	NR	Vite TE Parziale Filetto PG DIN 931 CI 10.9 M 16 x 110 Z.D.Bianca	Screw Partial Thread DIN 931 PG CI 10.9 M 16 x 110 ZD white
BV216	BV021600	NR	Vite TE Parziale Filetto PG DIN 931 CI 10.9 M 16 x 240 Z.D.Bianca	Screw Partial Thread DIN 931 PG CI 10.9 M 16 x 240 ZD white
BV217	BV021700	NR	Vite TSPEI PG DIN 7991 CI 10.9 M 8 x 30 Z.Bianca	TSPEI PG screw DIN 7991 CI 10.9 M8 x 30 Z. white
BV218	BV021800	NR	Vite TSPEI PG DIN 7991 CI 10.9 M 5 x 6 Z.Bianca	TSPEI PG screw DIN 7991 CI 10.9 M5 x 6 Z. white
BV219	BV021900	NR	Vite TSPEI PG DIN 7991 CI 10.9 M 5 x 70 Z.Bianca	TSPEI PG screw DIN 7991 CI 10.9 M5 x 70 Z. white
BV220	BV022000	NR	Vite TSPEI PG DIN 7991 CI 10.9 M 12 x 35 Z.Bianca	TSPEI PG screw DIN 7991 CI 10.9 M12 x 35 Z. white
BV221	BV022100	NR	Vite TCEI PG DIN 912 CI 12.9 M10 x 20 GEOMET 321A	Screw DIN 912 CI 12.9 M10 x 20 GEOMET 321A
BV222	BV022200	NR	Vite TCEI PG DIN 912 CI 12.9 M8 x 90 GEOMET 321A	Screw DIN 912 CI 12.9 M8 x 90 GEOMET 321A
BV223	BV022300	NR	Vite TCEI PG DIN 912 CI 12.9 M3 x 5 ZINC.	Screw DIN 912 CI 12.9 M3 x 5 ZINC.
BV224	BV022400	NR	Vite TBEI PG ISO 7380 CI 10.9 M 8 x 22 Z.Bianca	Hex socket screw ISO 7380 PG CI 10.9 M 8 x 22 Z. white
BV225	BV022500	NR	Vite TE Parziale Filetto PG DIN 931 CI 8.8 M 10 x 100 Z.Bianca	Screw Partial Thread DIN 931 PG CI 8.8 M 10 x 100 Z. white
BV226	BV022600	NR	Vite TE Parziale Filetto PG DIN 931 CI 8.8 M 10 x 110 Z.Bianca	Screw Partial Thread DIN 931 PG CI 8.8 M 10 x 110 Z. white
BV227	BV022700	NR	Vite TE Tutto Filetto PG DIN 933 CI 10.9 M 12 x 45 Z.D.Bianca	Screw All Thread DIN 933 PG CI 10.9 M 12 x 45 ZD white
BV228	BV022800	NR	Vite TE Tutto Filetto PG DIN 933 CI 10.9 M 14 x 35 Z.D.Bianca	Screw All Thread DIN 933 PG CI 10.9 M 14 x 35 ZD white
BV229	BV022900	NR	Vite TSPEI PG DIN 7991 CI 10.9 M 12 x 30 Z.Bianca	TSPEI PG screw DIN 7991 CI 10.9 M12 x 30 Z. white
BV230	BV023000	NR	Vite TE flangiata Tutto Filetto PG DIN 6921 CI 8.8 M 5 x 12 Zinconickel nero +sigillante	Flange Screw All Thread DIN 6921 PG CI 8.8 M 5 x 12 Zincnickel black +sealant



POS	Codice	U.M.	 Descrizione	 Description
BV231	BV023100	NR	Vite TE flangiata Tutto Filetto PG DIN 6921 CI 8.8 M 6 x 16 Zinconickel nero +sigillante	Flange Screw All Thread DIN 6921 PG CI 8.8 M 6 x 16 Zincnickel black +sealant
BV232	BV023200	NR	Vite TE Tutto Filetto PG DIN 933 CI 8.8 M 5 x 25 Z.D.Bianca	Screw All Thread DIN 933 PG CI 8.8 M 5 x 25 ZD white
BV233	BV023300	NR	Vite TE Tutto Filetto PG DIN 933 CI 8.8 M 8 x 130 Z.D.Bianca	Screw All Thread DIN 933 PG CI 8.8 M 8 x 130 ZD white
BV234	BV023400	NR	Vite TBEI PG ISO 7380 CI 10.9 M 8 x 22 Z.Bianca	Hex socket screw ISO 7380 PG CI 10.9 M 8 x 22 Z. white
BV235	BV023500	NR	Vite TE Tutto Filetto PG DIN 933 CI 10.9 M 16 x 35 Z.D.Bianca	Screw All Thread DIN 933 PG CI 10.9 M 16 x 35 ZD white
BV236	BV023600	NR	Vite TE Parziale Filetto PG DIN 931 CI 8.8 M 6 x 45 Z.Bianca	Screw Partial Thread DIN 931 PG CI 8.8 M 6 x 45 Z. white
BV237	BV023700	NR	Vite TE Tutto Filetto PG DIN 933 CI 10.9 M 12 x 30 Z.D.Bianca	Screw All Thread DIN 933 PG CI 10.9 M 12 x 30 ZD white

POS	Codice	U.M.	 Descrizione	 Description
RB1	RB000100	NR	DADO PER OGIVA Ø=12	NUT FOR OGIVA Ø = 12
RD1	RD000100	NR	RACCORDO CORPO A "T" EO F(DKOL)-M-M 8L	FITTING BODY A "T" EO F (DKOL) M-M-8L
RD2	RD000200	NR	RACCORDO CORPO A "T" EO F(DKOL)-M-M 10L	FITTING BODY A "T" EO F (DKOL) M-M-10L
RD3	RD000300	NR	RACCORDO CORPO A "T" EO F(DKOL)-M-M 12L	FITTING BODY A "T" EO F (DKOL) M-M-12L
RD4	RD000400	NR	RACCORDO CORPO A "T" EO F(DKOL)-M-M 15L	FITTING BODY A "T" EO F (DKOL) M-M-15L
RD5	RD000500	NR	RACCORDO CORPO A "T" EO M-F(DKOL)-M 10L	FITTING BODY A "T" EO M-F (DKOL) M-10L
RD6	RD000600	NR	RACCORDO CORPO A "T" EO M-F(DKOL)-M 12L	FITTING BODY A "T" EO M-F (DKOL) M-12L
RD7	RD000700	NR	RACCORDO CORPO A "T" EO 8L M 14*1.5	FITTING BODY A "T" EO 8L M 14 * 1.5
RD8	RD000800	NR	RACCORDO CORPO A "T" EO 10L M 16*1.5	FITTING BODY A "T" M 10L EO 16 * 1.5
RD9	RD000900	NR	RACCORDO CORPO A "T" EO 28L M 36*2	FITTING BODY A "T" M 28L EO 36 * 2
RD10	RD001000	NR	RACCORDO CORPO A "T" EO 28L M 36*2	FITTING BODY A "T" EO M-F (DKOL) M-10L
RD11	RD001100	NR	RACCORDO CORPO A "T" EO M-F(DKOL)-M 10L	FITTING BODY A "T" EO M-F (DKOL) M-10L
RG1	RG000100	NR	RACCORDO CORPO A GOMITO 10L MASCH.-FEMM. DKOL	ELBOW FITTING BODY 10L Masch.-FEMM. DKOL
RG2	RG000200	NR	RACCORDO CORPO A GOMITO 12L MASCH.-FEMM. DKOL	ELBOW FITTING BODY 12L Masch.-FEMM. DKOL
RG3	RG000300	NR	RACCORDO CORPO A GOMITO 20S MASCHIO-FEMMINA DKOS	20S BODY FITTING ELBOW MALE-FEMALE DKOS
RG4	RG000400	NR	RACCORDO CORPO A GOMITO 28L MASCHIO-FEMMINA DKOL	28L BODY FITTING ELBOW MALE-FEMALE DKOL
RG5	RG000500	NR	RACCORDO A L MASCHIO-FEMMINA 1/8	BODY 90 ° M / F 1/8 "

POS	Codice	U.M.	 Descrizione	 Description
RN1	RN000100	NR	RACCORDO CORPO D'ESTREMITA' TENUTA ED 8L * 3/8 GAS *K*	END FITTING WITH SEAL ED 8L * 3/8 GAS * K *
RN2	RN000200	NR	RACCORDO CORPO D'ESTREMITA' TENUTA ED 12L * 3/8 GAS *K*	END FITTING WITH SEAL ED 12L * 3/8 GAS * K *
RN3	RN000300	NR	RACCORDO CORPO D'ESTREMITA' TENUTA ED 10L * 3/8 GAS *K*	FITTING END OF BODY 'AND SEAL 10L * 3/8 GAS * K *
RN4	RN000400	NR	RACCORDO CORPO D'ESTREMITA' TENUTA ED 8L * 1/4 GAS *K*	END FITTING WITH SEAL ED 8L * 1/4 GAS * K *
RN5	RN000500	NR	RACCORDO CORPO D'ESTREMITA' TENUTA ED 10L * 1/4 GAS *K*	FITTING END OF BODY 'AND SEAL 10L * 1/4 GAS * K *
RN6	RN000600	NR	RACCORDO CORPO D'ESTREMITA' TENUTA ED 12L * 1/4 GAS	FITTING END OF BODY 'AND SEAL 12L * 1/4 GAS
RN7	RN000700	NR	RACCORDO NIPLES GAS CON.- GAS CON. 1/4" * 1/4"	FITTING
RN8	RN000800	NR	RACCORDO CORPO D'ESTREMITA' TENUTA ED 15L * 1/2 GAS *K*	END FITTING WITH SEAL ED 15L * 1/2 * K * GAS
RN9	RN000900	NR	RACCORDO CORPO D'ESTREMITA' TENUTA ED 10L * 1/2 GAS *K*	FITTING END OF BODY 'AND SEAL 10L * 1/2 * K * GAS
RN10	RN001000	NR	RACCORDO CORPO D'ESTREMITA' TENUTA ED 15L * 3/4 GAS *K*	END FITTING WITH SEAL ED 15L * 3/4 GAS * K *
RN11	RN001100	NR	RACCORDO CORPO D'ESTREMITA' TENUTA ED 12L * 1/2 GAS *K*	END FITTING WITH SEAL ED 12L * 1/2 GAS * K *
RN12	RN001200	NR	RACCORDO CORPO D'ESTR. TENUTA ED 8L * 1/2 GAS	END FITTING WITH SEAL ED 8L * 1/2 GAS
RN13	RN001300	NR	RACCORDO CORPO D'ESTR. TENUTA ED 8L * 3/4 GAS	CONNECTOR BODY OF EXTR. SEAL AND 8L * 3/4 GAS
RN14	RN001400	NR	RACCORDO CORPO D'ESTR. TENUTA ED 12L * 3/4 GAS	CONNECTOR BODY OF EXTR. SEAL AND 12L * 3/4 GAS
RN15	RN001500	NR	RACCORDO CORPO D'ESTR. TENUTA ED 15L * 3/8 GAS	END FITTING WITH SEAL ED 15L * 3/8 GAS
RN16	RN001600	NR	RACCORDO CORPO D'ESTR. TENUTA ED 22L * 3/4 GAS	END FITTING WITH SEAL ED 22L * 3/4 GAS

POS	Codice	U.M.	 Descrizione	 Description
RN17	RN001700	NR	RACCORDO CORPO D'ESTR. TENUTA ED 28L * 3/4" GAS	END FITTING WITH SEAL ED 28L * 3/4 BSP
RN18	RN001800	NR	RACCORDO CORPO D'ESTR. TENUTA ED 20S * 3/4 GAS	CONNECTOR BODY OF EXTR. SEAL AND 20S * 3/4 GAS
RN19	RN001900	NR	RACCORDO CORPO D'ESTREMITA' 8L * M 12X1.5 ED	END FITTING 8L * M 12x1.5 ED
RN20	RN002000	NR	RACCORDO CORPO D'ESTREMITA' 8L * M 14X1.5 ED	FITTING END OF BODY 'AND 8L * M 14x1.5
RN21	RN002100	NR	RACCORDO CORPO D'ESTREMITA' 10L * M 18X1.5 ED	END FITTING 10L * M 18x1.5
RN22	RN002200	NR	RACCORDO CORPO D'ESTR. TENUTA ED 15L * M 18X1.5	CONNECTOR BODY OF EXTR. SEAL AND 15L * M 18x1.5
RN23	RN002300	NR	RACCORDO CORPO D'ESTR. TENUTA ED 15L * M 22X1.5	END FITTING WIHT SEAL ED 15L * M 22x1.5
RN24	RN002400	NR	RACCORDO CORPO D'ESTR. TENUTA ED 22L * M26X1.5	CONNECTOR BODY OF EXTR. SEAL AND 22L * M26x1.5
RN25	RN002500	NR	RACCORDO CORPO D'ESTR. TENUTA ED 20S * M27X2	CONNECTOR BODY OF EXTR. SEAL AND 20S * M27X2
RN26	RN002600	NR	RACCORDO CORPO D'ESTR. 8L * 9/16-18 UNF-2A	END FITTING 8L * 9/16-18 UNF-2A
RN27	RN002700	NR	RACCORDO CORPO D'ESTR. 12L * 3/4 -16 UNF-2A	END FITTING 12L * 3/4 -16 UNF-2A
RN28	RN002800	NR	RACCORDO CORPO D'ESTR. 20S * 1.5/16 -12 UN-2A	END FITTING 20S * 1.5/16 -12 UN-2A
RN29	RN002900	NR	RACCORDO CORPO D'ESTR. TENUTA ED 22L * M26X1.5	END FITTING WITH SEAL ED 22L * M26x1.5
RN30	RN003000	NR	RACCORDO CORPO D'ESTR. TENUTA ED 22L * M26X1.5	END FITTING WITH SEAL ED 22L * M26x1.5
RN31	RN003100	NR	RACCORDO CORPO D'ESTREMITA' TENUTA ED 6L * 1/4 GAS *K*	END FITTING WITH SEAL 1/4 BSPP 6L
RN32	RN003200	NR	RACCORDO CORPO D'ESTREMITA' TENUTA ED 8L * 3/8 GAS *K*	END FITTING WITH SEAL ED 8L * 3/8 GAS * K *
RO1	RO000100	NR	OGIVA PER TUBO Ø=12	OGIVE FOR TUBE Ø = 12

POS	Codice	U.M.	 Descrizione	 Description
RR1	RR000100	NR	RONDELLA RAME 1/4	COPPER WASHER 1/4
RR2	RR000200	NR	RONDELLA BONDED GAS 3/8" *K*	BONDED WASHER GAS 3/8 " * K *
RR3	RR000300	NR	RONDELLA BONDED METRICA 12 *K*	METRIC BONDED WASHER 12 * K *
RR4	RR000400	NR	RONDELLA BONDED GAS 1/4" *K*	BONDED WASHER GAS 1/4 " * K *
RR5	RR000500	NR	RONDELLA BONDED GAS 1/2" *K*	BONDED WASHER GAS 1/2 " * K *
RR6	RR000600	NR	RONDELLA RAME 3/8	COPPER WASHER 3/8
RR7	RR000700	NR	RONDELLA BONDED GAS 1/8" *K*	BONDED WASHER GAS 1/8 " * K *
RR8	RR000800	NR	RONDELLA BONDED GAS 1" *K*	BONDED WASHER GAS 1 " * K *
RR9	RR000900	NR	RONDELLA BONDED GAS 3/4" *K*	BONDED WASHER GAS 3/4 " * K *
RR10	RR001000	NR	RONDELLA BONDED GAS 1.1/4"	BONDED WASHER GAS 1.1 / 4 "
RR11	RR001100	NR	RONDELLA RAME 1/8	COPPER WASHER 1/8
RR12	RR001200	NR	RONDELLA RAME 1/2	COPPER WASHER 1/2
RS1	RS000100	NR	COPPIA SEMIFLANGE SAE 6000 3/4"	PAIR 6000 SAE flange halves 3/4 "
RS2	RS000200	NR	RACC.M 20S(M30x2) - ED M 1"5/16 UNF H=33	FITTING M 20S (M30x2) - ED M 1 "5/16 UNF H = 33
RS3	RS000300	NR	RIDUZIONE M-F GAS 1" * 1/2"	REDUCING GAS M-F 1 " * 1/2"
RS4	RS000400	NR	RACCORDO COLONNETTA M15L - 3/8" GAS H=50	COLUMN CONNECTION M15L - 3/8 "GAS H = 50
RS5	RS000500	NR	RACCORDO COLONNETTA M15L - 3/8" GAS H=96	COLUMN CONNECTION M15L - 3/8 "GAS H = 96
RS6	RS000600	NR	CODOLO M1/4" ED X FG 8L (M14X1.5)	FITTING M1 / 4 "X AND FG 8L (M14X1.5)

POS	Codice	U.M.	 Descrizione	 Description
RS7	RS000700	NR	RIDUZIONE M-F GAS 1" * 1/2"	REDUCING GAS M-F 1 " * 1/2"
RS8	RS000800	NR	RACCORDO CODOLO D' ESTR. FEM. DKO 12I*3/8 GAS ED	END FITTING FEM. DKO 12I*3/8 GAS ED
RT1	RT000100	NR	TAPPO MASCHIO TE GAS 3/8" SVASATO 60° *K*	SCREW EYE FOR GAS 1/2 "H = 50
RT2	RT000200	NR	TAPPO MASCHIO ESAGONO INTERNO GAS 1/4" SVASATO 60° *K*	MALE PLUG GAS INTERNAL HEX 1/4 "FLARE 60 ° * K *
RT3	RT000300	NR	TAPPO MASCHIO TE GAS 1/2" SVASATO 60° *K*	MALE PLUG TE GAS 1/2 "FLARE 60 ° * K *
RT4	RT000400	NR	TAPPO MASCHIO TE GAS 1/4" SVASATO 60° *K*	MALE PLUG TE GAS 1/4 "FLARE 60 ° * K *
RT5	RT000500	NR	TAPPO MASCHIO ESAGONO INTERNO GAS 3/8" SVASATO 60° *K*	MALE PLUG GAS INTERNAL HEX 3/8 "FLARE 60 ° * K *
RT6	RT000600	NR	TAPPO MASCHIO ESAGONO INTERNO GAS 1" SVASATO 60° *K*	MALE PLUG GAS INTERNAL HEX 1 "FLARE 60 ° * K *
RV1	RV000100	NR	VITE PER OCCHIO GAS 1/4" H=29 *K*	SCREW EYE FOR GAS 1/4 "H = 29 * K *
RV2	RV000200	NR	VITE PER OCCHIO DOPPIA GAS 3/8"	SCREW EYE DOUBLE FOR GAS 3/8 "
RV3	RV000300	NR	VITE PER OCCHIO GAS 1/2" H= 50	SCREW EYE FOR GAS 1/2 "H = 50
RV4	RV000400	NR	VITE PER OCCHIO DOPPIA GAS 1/4"	DOUBLE EYE SCREW FOR GAS 1/4"
RV5	RV000500	NR	VITE PER OCCHIO GAS 3/8"	SCREW EYE FOR GAS 3/8"

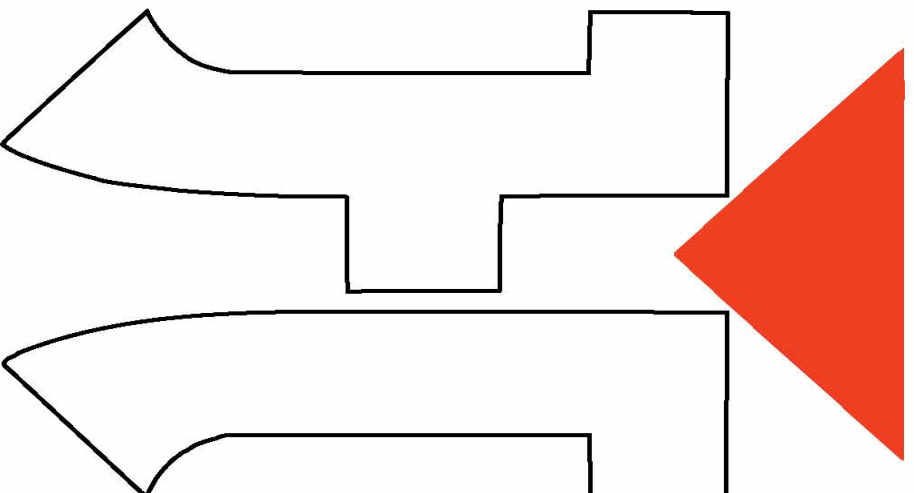

HINOWA SPA.
Via Fontana 37054 NOGARA (VR) - Italy
Tel. +39 0442 539100 Fax +39 0442 539075
E-mail: hinowa@hinowa.it Web site: www.hinowa.com
Marketing: info@hinowa.com



An Oshkosh Corporation Company

JLG Industries, Inc.
1 JLG Drive
McConnellsburg PA. 17233-
9533
USA

(717) 485-5161

(717) 485-6417

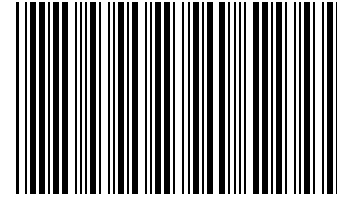

3121601

JLG Worldwide Locations

JLG Industries (Australia)
P.O. Box 5119
11 Bolwarra Road
Port Macquarie
N.S.W. 2444
Australia

+61 2 65 811111

+61 2 65 810122

JLG Latino Americana Ltda.
Rua Eng. Carlos Stevenson,
80-Suite 71
13092-310 Campinas-SP
Brazil

+55 19 3295 0407

+55 19 3295 1025

JLG Industries (UK) Ltd
Bentley House
Bentley Avenue
Middleton
Greater Manchester
M24 2GP - England

+44 (0)161 654 1000

+44 (0)161 654 1001

JLG France SAS
Z.I. de Fauillet
47400 Tonneins
France

+33 (0)5 53 88 31 70

+33 (0)5 53 88 31 79

JLG Deutschland GmbH
Max-Planck-Str. 21
D - 27721 Ritterhude - Ihlpohl
Germany

+49 (0)421 69 350 20

+49 (0)421 69 350 45

JLG Equipment Services Ltd.
Rm 1107 Landmark North
39 Lung Sum Avenue
Sheung Shui N. T.
Hong Kong

(852) 2639 5783

(852) 2639 5797

JLG Industries (Italia) s.r.l.
Via Po. 22
20010 Pregnana Milanese - MI
Italy

+39 029 359 5210

+39 029 359 5845

Oshkosh - JLG Singapore T. E. P. Ltd.
29 Tuas Ave 4
Jurong Industrial Estate
639379
Singapore

+65-6591-9030

+65-6591-9031

Plataformas Elevadoras
JLG Iberica, S.L.
Trapadella, 2
P.I. Castellbisbal Sur
08755 Castellbisbal, Barcelona
Spain

+34 93 772 4700

+34 93 771 1762

JLG Sverige AB
Enkopingsvagen 150
Box 704
SE - 176 27 Jarfalla
Sweden

+46 (0)850 659 500

+46 (0)850 659 534

www.jlg.com