



An Oshkosh Corporation Company

---

# ***Illustrated Parts Manual***

## ***Compact Crawler***

***X17J/3***

***X17J/4***



---

**3121602**  
March 12, 2018



 SOTTOCARRO CINGOLATO

RAUPENFAHRWERK 

 TRACKED UNDERCARRIAGE

CARRO DE ORUGAS 



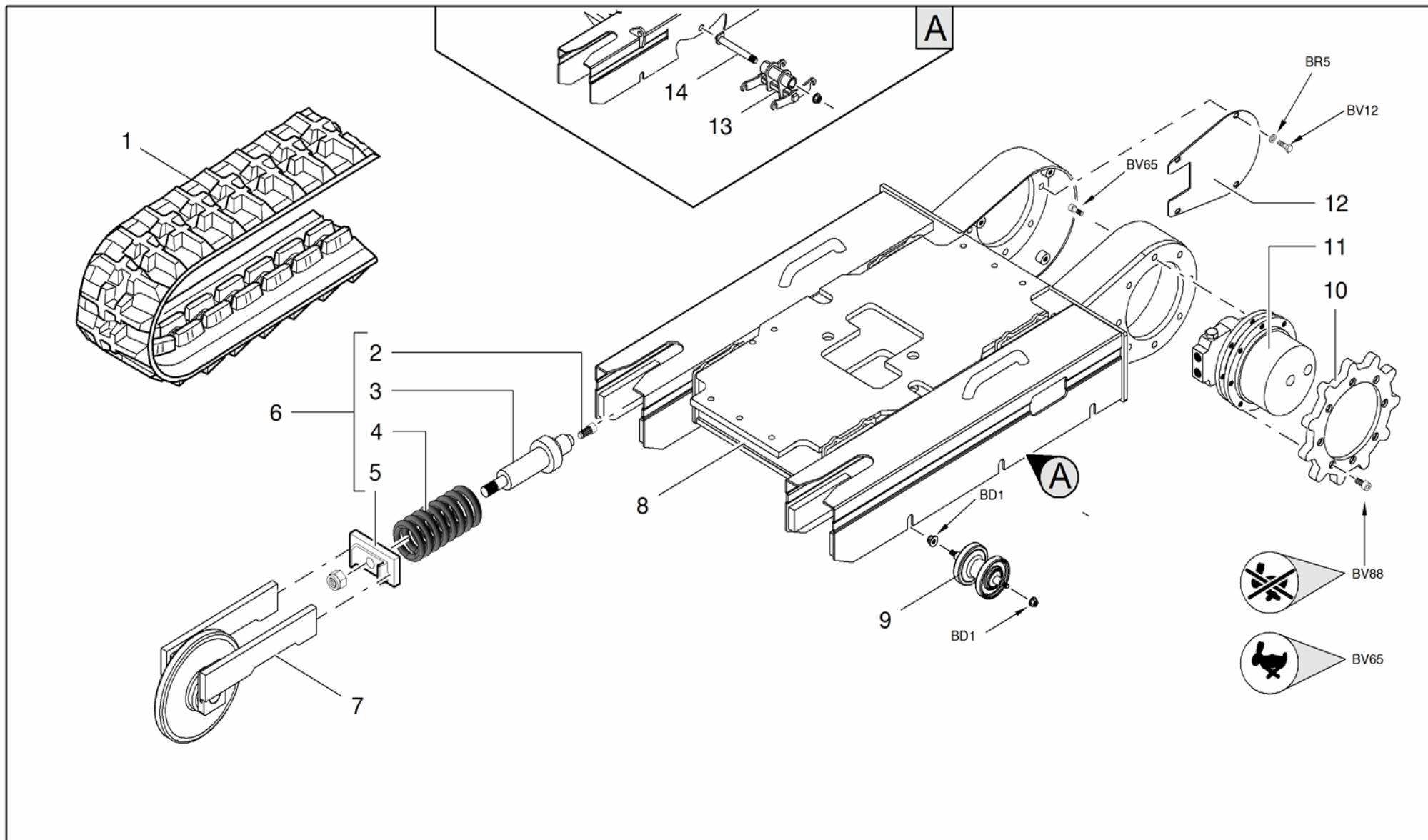

 CHENILLARD



 SOTTOCARRO CINGOLATO

 RAUPENFAHRWERK 
 TRACKED UNDERCARRIAGE

 CARRO DE ORUGAS 
 CHENILLARD

POS	Codice	Q.tà	 Descrizione	 Description	 Designation	 Benennung	 Descripció
1	05371500	2 NR	cingolo in gomma alto profilo nero	rubber track standard high profile black	chenille en caoutchouc	gummiraupe	oruga de goma
1	053715L0	2 NR	cingolo in gomma basso profilo nero	rubber track low profile black	chenille en caoutchouc	gummiraupe	oruga de goma
1	053715LB	2 NR	cingolo in gomma basso profilo antitraccia	rubber track low profile no marking	chenille en caoutchouc	gummiraupe	oruga de goma
2	03149200	1 NR	valvola idraulica	hydraulic valve	valve hydraulique	valve hydraulique	válvula hidráulica
3	10681670	1 NR	cilindro	cylinder	vérin	zylinder	cilindro
4	03024800	1 NR	molla	spring	ressort	feder	muelle
5	34719500	1 NR	piatto	plate	plateau	platte	placa
6	14753400	2 NR	supporto tendicingolo	idler support	support tendeur chenille	kettehspanner-halter	soporte tensor oruga
7	15393700	2 NR	ruota tendicingolo	idler wheel	roue tendeur de chenille	raupenspannrad	rueda tensor oruga
8	15385700	1 NR	sottocarro cingolato	tracked undercarriage	chenillard	raupenfahrwerk	carro con orugas
9	15351500	6 NR	rullo inferiore	carrier roller	rouleau inférieur	untere roller	rodillo inferior
10	04173600	2 NR	ruota di trazione	sprocket wheel	roue de traction	antriebsrad	rueda de arrastre
10	07028900	2 NR	ruota di trazione 2 velocità	sprocket wheel high speed	roue de traction	antriebsrad	rueda de arrastre





 SOTTOCARRO CINGOLATO

RAUPENFAHRWERK 

 TRACKED UNDERCARRIAGE

CARRO DE ORUGAS 

 CHENILLARD

POS Codice	Q.tà	 Descrizione	 Description	 Designation	 Benennung	 Descripcìon
11 14741100	2 NR	motoriduttore	motorgearbox	motoréducteur	getriebemotor	motorreductor
11 27028800	2 NR	motore idraulico 2 velocità	hydraulic motor high speed	moteur hydraulique	hydraulikmotor	motor hidráulico
12 05380900	2 NR	coperchio	cover	couvercle	deckel	tapa
12 05486800	2 NR	coperchio 2 velocità	cover high speed	couvercle	tapa	deksel

 ALLARGAMENTO IDRAULICO

 HYDRAULIC EXTENSION

 ECARTEMENT HYDRAULIQUE

HYDR. SPURWEITENVER STELLEINRICHTUNG 



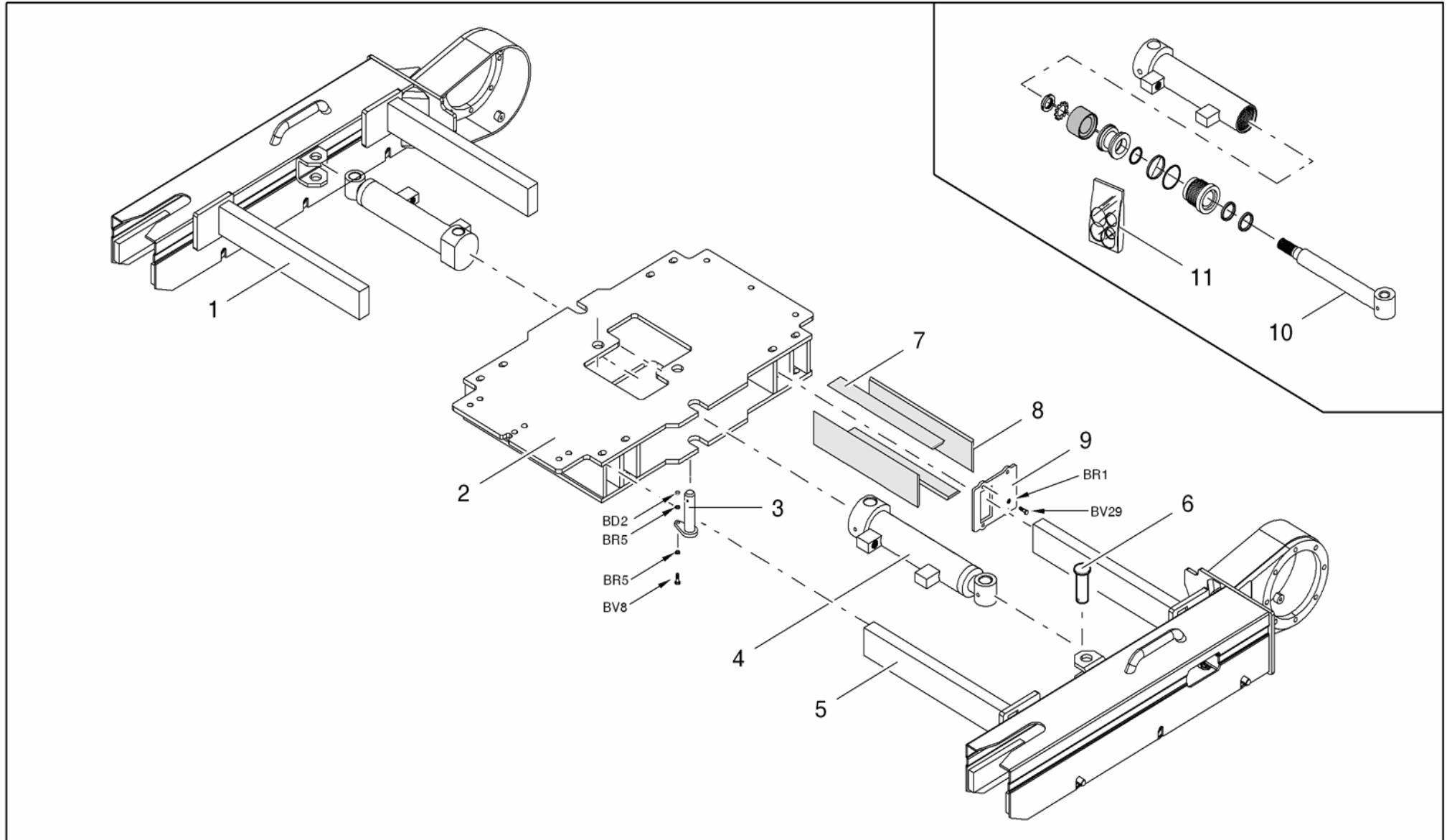

EXTENSION HIDRAULICA 



 ALLARGAMENTO IDRAULICO

 HYDR. SPURWEITENVER STELLEINRICHTUNG 
 HYDRAULIC EXTENSION

 EXTENSION HIDRAULICA 
 ECARTEMENT HYDRAULIQUE

POS	Codice	Q.tà	 Descrizione	 Description	 Designation	 Benennung	 Descripción
1	35385700	1 NR	assieme longherone destro	right side frame assembly	ensemble châssis latéral longeron droit	längsträgerbaugrup pe rechts	conjunto larguero derecho
1	35603000	1 NR	assieme longherone destro 2 velocità	right side frame assembly high speed	ensemble châssis latéral longeron droit	längsträgerbaugrup pe rechts	conjunto larguero derecho
2	35385300	1 NR	struttura	structure	structure	struktur	estructura
3	05419700	2 NR	spina	pin	cheville	stif	clavija
4	14255300	2 NR	cilindro allargamento	cylinder	verin	zylinder	cilindro
5	35385800	1 NR	assieme longherone sinistro	left side frame assembly	ensemble châssis latéral long. gauche	längsträgerbaugrup pe links	conjunto larguero izquierdo
5	35603100	1 NR	assieme longherone sinistro 2 velocità	left side frame assembly high speed	ensemble châssis latéral long. gauche	längsträgerbaugrup pe links	conjunto larguero izquierdo
6	04256300	2 NR	spina	pin	cheville	stift	clavija
7	04624900	8 NR	guida allargamento	expansion guide	glissière élargissement	führungsverbreiteru ng	guía de extensión
8	04624800	8 NR	guida allargamento	expansion guide	glissière élargissement	führungsverbreiteru ng	guía de extensión
9	34610800	4 NR	coperchio	cover	couvercle	deckel	tapa
10	34735700	1 NR	stelo	rod	tige	schaft	vástago





 ALLARGAMENTO IDRAULICOHYDR. SPURWEITENVER STELLEINRICHTUNG  HYDRAULIC EXTENSIONEXTENSION HIDRAULICA  ECARTEMENT HYDRAULIQUE

POS Codice	Q.tà	 Descrizione	 Description	 Designation	 Benennung	 Descripcìon
11 14736000	1 NR	kit guarnizioni	gasket kit	kit joints	dichtungssatz	kit guarnicións













 BASE TORRETTA
ARBEITSTURM 
 TURRET BASE
BASE TORRETA GIRATORIA 
 BASE TOURELLE

POS Codice	Q.tà	 Descrizione	 Description	 Designation	 Benennung	 Descripción
1 05611000	3 NR	galletto	wing nut	ecrou papillon	flügelmutter	tuerca de mariposa
2 069449J0	1 NR	coperchio	cover	couvercle	deckel	tapa
3 06934900	2 NR	spessore	thickness	cale	stärke	espesor
4 06934800	2 NR	spessore	thickness	cale	stärke	espesor
5 369370J0	1 NR	scatola componenti elettrici	electrical box	coffret électrique	schaltkasten	caja eléctrica
6 26945000	1 NR	ralla	fifth wheel	couronne dentée	drehkranz	tejuelo
7 36887500	1 NR	base torretta	turret base	base tourelle	arbeitsturm	base torreta giratoria
8 368866J0	1 NR	protezione	protection	protection	schutz	protección
9 068863J0	1 NR	lama di fissaggio	fixing blade	lame de fixage	befestigungsschild	lama fijación
10 061187Y1	1 NR	piastra	plate	platine	platte	placa
11 06118500	1 NR	lamiera piegata	folded plate	tôle pliée	blech gebogen	chapa doblada
12 368865J0	1 NR	supporto	support	support	halterung	soporte
13 06900400	4 NR	spina	pin	cheville	stif	clavija
14 04834500	1 NR	avvisatore acustico	acoustic alarm	avertisseur sonore	hupe	avisador acústico
15 06891100	1 NR	fermo	retainer	arrêt	halterung	bloque

 BASE TORRETTA
ARBEITSTURM 
 TURRET BASE
BASE TORRETTA GIRATORIA 
 BASE TOURELLE

POS Codice	Q.tà	 Descrizione	 Description	 Designation	 Benennung	 Descripcìon
16 159497J0	1 NR	serbatoio olio completo	complete oil tank	réservoir d'huile complet	öltank komplett	depósito de aceite completo
17 06958700	1 NR	piegato fissaggio spina elettrica 16a	fixing folded electric plug 16a	tôle pliée	blech gebogen	chapa doblada
18 07002500	1 NR	carter	sump	carter	kurbelgehäuse	cárter
19 06888700	1 NR	riscontro	fastener locator	plaque pour agrafage	anschlag	gancho
20 26945001	1 NR	freno	brake	de frein	bremse	freno
21 168913J0	4 NR	stabilizzatore completo	complete stabilizer	stabilisateur complet	stabilizer komplett	estabilizador completo
22 06272800	2 NR	boccola	bush	douille	buchse	casquillo
23 05876400	4 NR	antivibrante	anti-vibrating	anti - vibrant	vibrationsdämpfer	antivibrante
24 06901200	4 NR	spina	pin	cheville	stif	clavija
25 05446300	4 NR	disco	disk	disque	scheibe	disco
26 05446400	8 NR	semiflangia	half flange	demi-bride	halb flansch	semi brida
27 05333300	8 NR	collare	clamp	collar	collar	collar
28 05625800	4 NR	piastrina	plate	plaquette	plättchen	placa
29 06891000	1 NR	staffa	bracket	étrier	haltebügel	estribo
30 04096900	2 NR	morsetto	clamp	borne	klemme	borne

 BASE TORRETTA
ARBEITSTURM 
 TURRET BASE
BASE TORRETTA GIRATORIA 
 BASE TOURELLE

POS Codice	Q.tà	 Descrizione	 Description	 Designation	 Benennung	 Descripción
31 35933000	4 NR	supporto	support	support	halterung	soporte
32 07495600	0,42 NR	gomma adesiva di protezione	rubber adhesive protection	gomme adhesive de protection	schutz-klebegummi	goma adhesiva de protección
33 26944400	1 NR	motore di rotazione	rotary motor	moteur de rotation	rotationsmotor	motor de rotación
34 05959100	2 NR	protezione sinistra	protection left	protection gauche	schutz link	protección
35 05932800	2 NR	protezione destra	protection right	protection droite	schutz recht	protección
36 359284J0	1 NR	supporto motore benzina	support petrol engine	support	halterung	soporte
36 361780J0	1 NR	supporto motore diesel	support diesel engine	support	halterung	soporte
37 05562900	1 NR	staffa	bracket	étrier	haltebügel	estribo
38 061617J0	1 NR	coperchio	cover	couvercle	deckel	tapa
39 161634J0	1 NR	protezione motore benzina	protection petrol engine	protection	schutz	protección
39 361781J0	1 NR	protezione motore diesel	protection diesel engine	protection	schutz	protección
40 36851000	1 NR	cassone	dumper bed	caisson	dumpermulde	cajon
41 06853100	1 NR	coperchio	cover	couvercle	deckel	tapa
42 06780800	1 NR	tappo ventola posteriore	cap rear fan	bouchon	verschluss	tapón





 BASE TORRETTA

ARBEITSTURM 

 TURRET BASE

BASE TORRETA GIRATORIA 

 BASE TOURELLE

POS Codice	Q.tà	 Descrizione	 Description	 Designation	 Benennung	 Descripcìon
43 06779900	1 NR	tappo ventola anteriore	cap front fan	bouchon	verschluss	tapón
44 06550100	1 NR	vite m16x20 testa ribassata	reduced head screw m16x20	baisse vis à tête m16x20	gesenkten kopf screw m16x20	bajado tornillo cabeza m16x20

 SERBATOIO OLIO

ÖLTANK 

 OIL TANK

DEPÓSITO DE ACEITE 

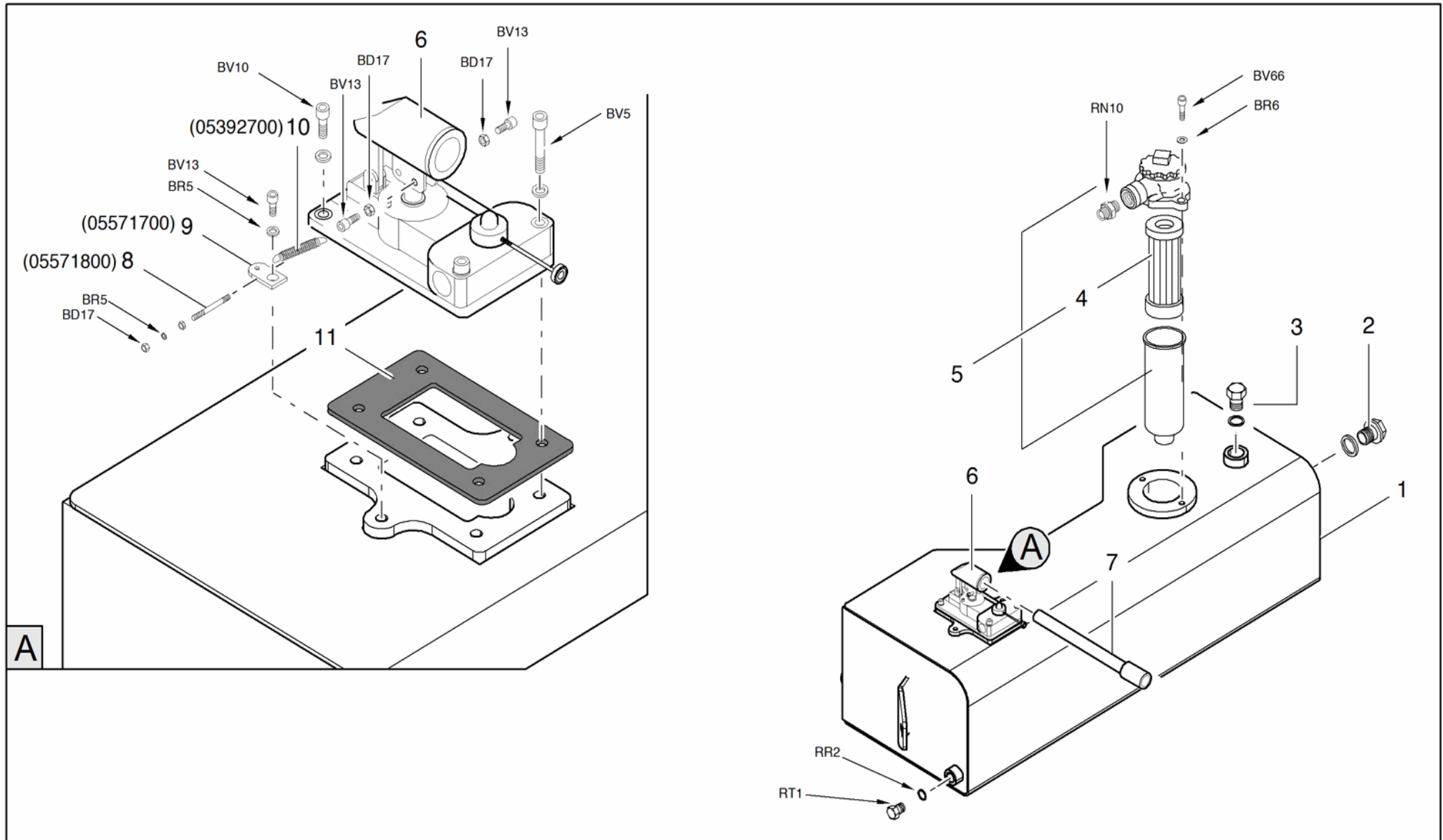

 RÉSERVOIR D'HUILE



 SERBATOIO OLIO

 ÖLTANK 
 OIL TANK





 DEPÓSITO DE ACEITE 
 RÉSERVOIR D'HUILE

POS Codice	Q.tà	 Descrizione	 Description	 Designation	 Benennung	 Descripción
1 35949700	1 NR	serbatoio olio	oil tank	réservoir d'huile	öltank	depósito de aceite
1 359497J0	1 NR	serbatoio olio	oil tank	réservoir d'huile	öltank	depósito de aceite
2 05061800	1 NR	livello olio	oil level	niveau huile	ölstand	nivel aceite
3 05611800	1 NR	tappo olio	oil plug	bouchon d'huile	öldeckel	tapón aceite
4 05120200	1 NR	cartuccia filtro olio idraulico	oil filter insert	filtre à huile	ölfilter	filtro aceite
5 15120100	1 NR	filtro olio idraulico completo	complete hydraulic oil filter	filtre à huile	ölfilter	filtro aceite
6 27316300	1 NR	pompa a mano	hand pump	pompe manuelle	handpumpe	bomba de mano
7 05521300	1 NR	leva	lever	levier	hebel	palanca
11 2550890001	1 NR	guarnizione di base per pompa a mano	basic gasket for hand pump	joint		









 PRIMO BRACCIO
ERSTER AUSLEGERARM 
 FIRST ARM
PRIMO BRAZO 
 PREMIER BRAS

POS Codice	Q.tà	 Descrizione	 Description	 Designation	 Benennung	 Descripción
1 07094100	4 NR	pattino	slide block	patin	gleitblock	patín
2 368688J0	1 NR	rinvio 1° - 2° braccio	1° - 2° arm transmission	renvoi 1° - 2° bras	vorgelege 1°-2° arm	reenvio 1° - 2° brazo
3 168982J0	1 NR	primo braccio completo	complete first arm	premier bras complète	erste arm ergänzen	primo brazo completo
4 06326300	4 NR	boccola	bush	douille	buchse	casquillo
5 168765J0	1 NR	tirante completo	complete tie rod	liens complets	vollständige verknüpfung	ligamiento completo
6 06870800	3 NR	spina	pin	cheville	stif	clavija
7 06877300	1 NR	spina	pin	cheville	stif	clavija
8 06883900	3 NR	spina	pin	stif	stif	clavija
9 06944800	4 NR	zavorra	ballast	lest	ballast	contrapeso
10 368782J0	1 NR	supporto	support	support	halterung	soporte
11 069590H3	1 NR	protezione	protection	protection	schutz	protección
12 06900800	1 NR	carter	sump	carter	kurbelgehäuse	cárter
13 36887200	1 NR	protezione	protection	protection	schutz	protección
14 06935000	1 NR	indice allineamento	alignment indicator	indicateur d'alignement	ausrichtungsanzeig e	indicador alineación

 PRIMO BRACCIO
ERSTER AUSLEGERARM 
 FIRST ARM
PRIMO BRAZO 
 PREMIER BRAS

POS Codice	Q.tà	 Descrizione	 Description	 Designation	 Benennung	 Descripción
15 05967900	1 NR	indice allineamento fisso	fixed alignment indicator	indicateur d'alignement fixe	fixe ausrichtungsanzeig e	indicador alineación fijo
16 06891200	1 NR	perno	pin	goujon	zapfen	pernio
17 064422Y1	1 NR	fermo	retainer	arrêt	halterung	bloque
18 058832H3	1 NR	supporto	support	support	halterung	soporte
19 05444800	3 NR	molla	spring	ressort	feder	muelle
20 05427200	1 NR	livella	level	niveau	wasserwaage	nivel de burbuja

 SECONDO BRACCIO

ZWEITER AUSLEGERARM 



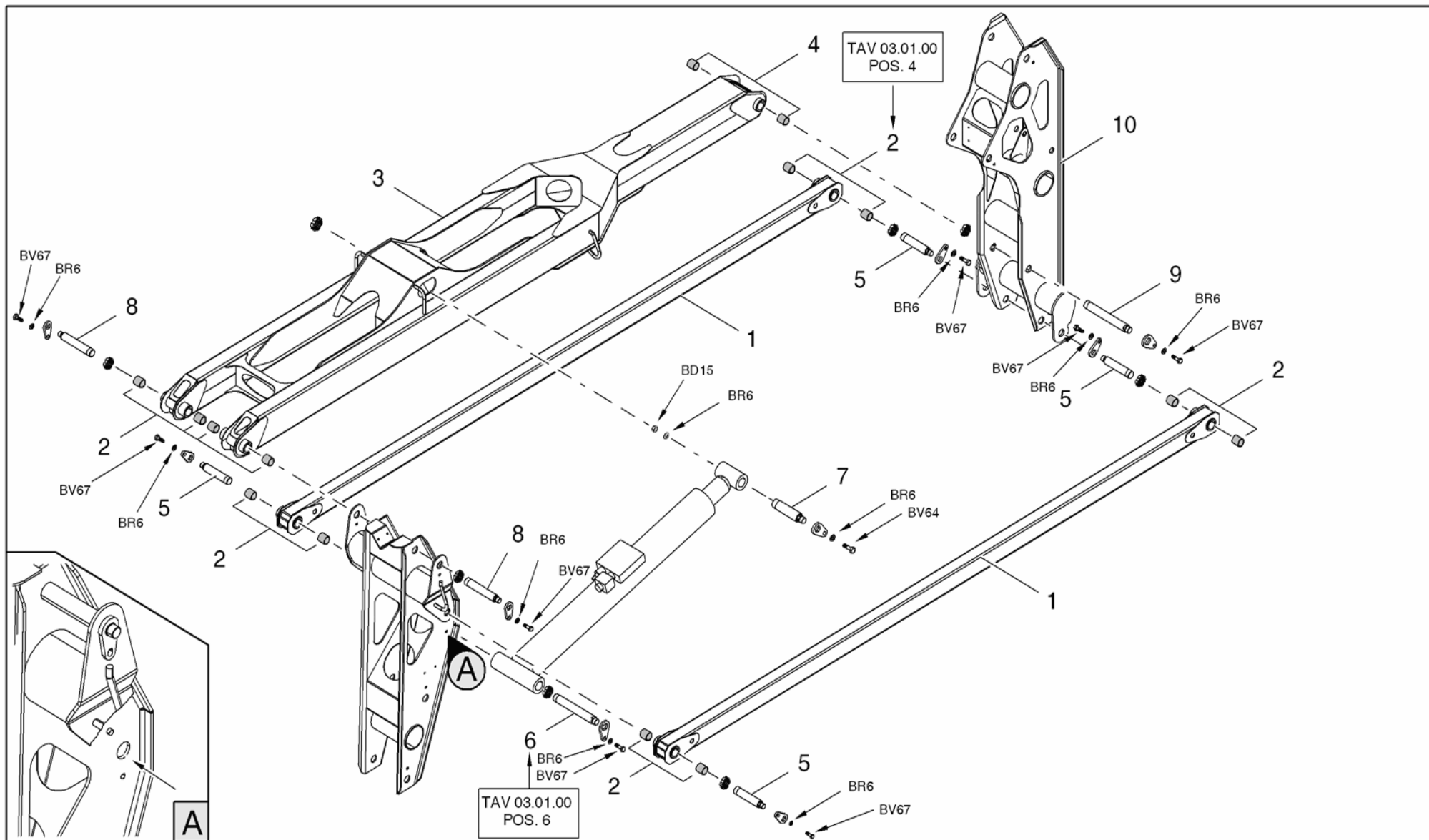

 SECOND ARM

SEGUNDO BRAZO 

 SECOND BRAS



 SECONDO BRACCIO
ZWEITER AUSLEGERARM 
 SECOND ARM
SEGUNDO BRAZO 
 SECOND BRAS

POS Codice	Q.tà	 Descrizione	 Description	 Designation	 Benennung	 Descripciòn
1 168712J0	2 NR	tirante completo	complete tie rod	liens complets	vollständige verknüpfung	ligamiento completo
3 168713J0	1 NR	secondo braccio completo	complete second arm	deuxième bras complète	zweiter arm ergänzen	segundo brazo completo
4 06586200	2 NR	boccola	bush	douille	buchse	casquillo
5 06937500	4 NR	spina	pin	cheville	stif	clavija
7 06870900	1 NR	spina	pin	cheville	stif	clavija
8 06626800	2 NR	spina	pin	cheville	stif	clavija
9 06854000	3 NR	spina	pin	cheville	stif	clavija
10 368678J0	1 NR	rinvio 2° - 3° braccio	2° - 3° arm transmission	renvoi 1° - 3° bras	vorgelege 2°-3° arm	reenvio 2° - 3° brazo

 TERZO BRACCIO

THIRD AUSLEGERARM 

 THIRD ARM

TERCERO BRAZO 

 TIERS BRAS

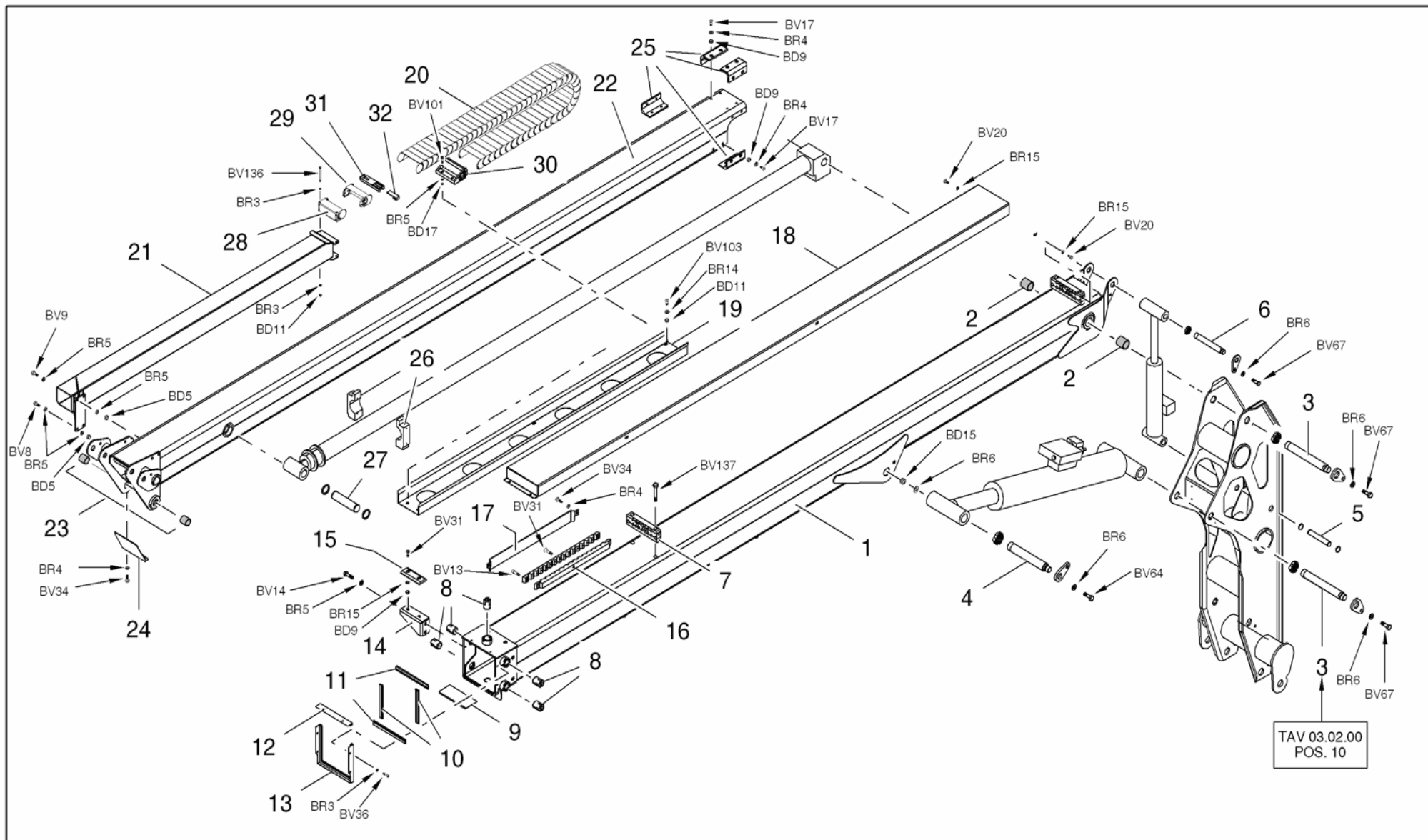

 TERZO BRACCIO

 THIRD AUSLEGERARM 
 THIRD ARM





 TERCERO BRAZO 
 TIERS BRAS

POS Codice	Q.tà	 Descrizione	 Description	 Designation	 Benennung	 Descripción
1 168639J0	1 NR	terzo braccio completo	complete third arm	complete troisième bras	komplette dritten arm	tercer brazo completo
2 06422000	2 NR	boccola	bush	douille	buchse	casquillo
4 06853900	1 NR	spina	pin	cheville	stif	clavija
5 06867600	1 NR	spina	pin	cheville	stif	clavija
6 06854100	1 NR	spina	pin	cheville	stif	clavija
7 06951700	1 NR	morsetto	clamp	borne	klemme	borne
8 06958600	5 NR	pattino	slide block	patin	gleitblock	patín
9 06867200	1 NR	pattino	slide block	patin	gleitblock	patín
10 06900600	2 NR	spazzola verticale	vertical brush	brosse verticale	senkrechte bürste	cepillo vertical
11 06900500	2 NR	spazzola orizzontale	horizontal brush	brosse horizontale	waagrechte bürste	cepillo horizontal
12 06867300	1 NR	spazzola	brush	brosse	bürste	cepillo
13 06867400	1 NR	lama di fissaggio	fixing blade	lame de fixage	befestigungsschild	lama fijación
14 06866300	1 NR	supporto	support	support	halterung	soporte
15 06867100	1 NR	pattino	slide block	patin	gleitblock	patín
16 06884000	1 NR	blocchetto	block	bloc	block	bloque
17 06864900	1 NR	protezione	protection	protection	schutz	protección

 TERZO BRACCIO
THIRD AUSLEGERARM 
 THIRD ARM
TERCERO BRAZO 
 TIERS BRAS

POS Codice	Q.tà	 Descrizione	 Description	 Designation	 Benennung	 Descripción
18 06864800	1 NR	carter	sump	carter	kurbelgehäuse	cárter
19 06864700	1 NR	supporto	support	support	halterung	soporte
20 26899800	1 NR	catena portacavi	cable-holder chain	chaîne porte-câbles	kabelhalterkette	cadena portacables
21 368632J0	1 NR	tubo	pipe	tuyau	rohr	tubo
22 168622J0	1 NR	braccio sfilo completo	complete arm extension	bras extension complète	arm erweiterung ergänzen	brazo extensión completo
23 06900700	2 NR	boccola	bush	douille	buchse	casquillo
24 06863100	1 NR	coperchio	cover	couvercle	deckel	tapa
25 06867500	4 NR	pattino	slide block	patin	gleitblock	patín
26 06868000	1 NR	pattino	slide block	patin	gleitblock	patín
27 06853800	1 NR	spina	pin	cheville	stif	clavija
28 2689980004	1 NR	attacco maschio catena portacavi	male connection cable-holder chain	chaîne porte-câbles	kabelhalterkette	cadena portacables
29 2689980001	1 NR	maglia catena portacavi	cable-holder chain mesh	chaîne porte-câbles	kabelhalterkette	cadena portacables
30 2689980005	1 NR	attacco femmina catena portacavi	female connection cable-holder chain	chaîne porte-câbles	kabelhalterkette	cadena portacables
31 2689980002	1 NR	fascetta trasverso catena portacavi	cable-holder chain clamp	chaîne porte-câbles	kabelhalterkette	cadena portacables

 TERZO BRACCIOTHIRD AUSLEGERARM  THIRD ARMTERCERO BRAZO  TIERS BRAS

POS Codice	Q.tà	 Descrizione	 Description	 Designation	 Benennung	 Descripcìon
32 2689980003	1 NR	fermo fascetta catena portacavi	cable-holder chain retainer clamp	chaîne porte-câbles	kabelhalterkette	cadena portacables









 SUPPORTO CESTO

 HALTERUNG ARBEITSKORB 
 BASKET SUPPORT





 SOPORTE CESTA 
 PANIER CUPPORT

POS Codice	Q.tà	 Descrizione	 Description	 Designation	 Benennung	 Descripcìon
1 359447J0	1 NR	tirante jib	tie rod jib	tirant	turmgestänge	tirante
2 368615J0	1 NR	tirante	tie rod	tirant	turmgestänge	tirante
3 06853500	2 NR	spina	pin	cheville	stif	clavija
4 05507000	2 NR	fermo	retainer	arrêt	halterung	bloque
5 06981600	1 NR	collare	collar	bride	bundring	collar
6 06981700	1 NR	tubo	pipe	tuyau	rohr	tubo
7 168617J0	1 NR	braccio jib	jib arm	fléchette bras	arm - schwenkarm ergänzen	brazo jib
8 168616J0	1 NR	braccio jib	jib arm	fléchette bras	arm - schwenkarm ergänzen	brazo jib
9 06272600	4 NR	boccola	bush	douille	buchse	casquillo
10 06853400	4 NR	spina	pin	cheville	stif	clavija
11 06853600	1 NR	spina	pin	cheville	stift	clavija
12 168602J0	1 NR	rinvio	transmission	renvoi	vorgelege	reenvio
13 06272700	2 NR	boccola	bush	douille	buchse	casquillo
14 06630800	1 NR	spina	pin	cheville	stif	clavija
15 06630600	1 NR	spina	pin	cheville	stif	clavija
16 06853700	1 NR	spina	pin	cheville	stif	clavija

 SUPPORTO CESTO

 HALTERUNG ARBEITSKORB 
 BASKET SUPPORT





 SOPORTE CESTA 
 PANIER CUPPORT

POS Codice	Q.tà	 Descrizione	 Description	 Designation	 Benennung	 Descripción
17 2648910002	1 NR	kit guarnizioni	seal kit	trousse de joint	dichtung kit	kit de juntas
17 264891J0	1 NR	motore di rotazione	rotary motor	moteur de rotation	rotationsmotor	motor de rotación
18 07173700	1 NR	piastra	plate	platine	platte	placa
19 168592J0	1 NR	supporto distributore su cesto completo	support distributor basket	soutenir le distributeur panier complètement	unterstützen sie das verteilkorb full	apoyo a la cesta distribuidor completo
20 06859500	1 NR	carter	sump	carter	kurbelgehäuse	cárter
20 068595J0	1 NR	carter	sump	carter	kurbelgehäuse	cárter
21 36859800	1 NR	protezione	protection	protection	schutz	protección
22 06859700	1 NR	piatto	plate	plateau	platte	placa
22 068597J0	1 NR	piatto	plate	plateau	platte	placa
23 05643600	1 NR	cassetta portamanuale	manual box	boîte porte-manuel	bedienungsanleitung gsfach	caja portamanual
24 06477600	1 NR	magnete ø20 con foro m3	magneto ø20 with m3 hole	aimant	magnet	imán
25 06613300	1 NR	piastra	plate	platine	platte	placa
26 06058300	2 NR	tappo	cap	bouchon	verschluss	tapón
27 36057800	1 NR	slitta	slide	coulisseau	schlitten	corredera
28 26084300	4 NR	cuscinetto	bearing	coussinet	lager	cojinete





 SUPPORTO CESTO

 HALTERUNG ARBEITSKORB 
 BASKET SUPPORT

 SOPORTE CESTA 
 PANIER CUPPORT

POS Codice	Q.tà	 Descrizione	 Description	 Designation	 Benennung	 Descripción
29 05863600	2 NR	tubo supporto cesto (fornito a ricambio assemblato al perno 05863700)	tube basket holder (spare parts provided assembled with the pin 05863700)	tuyau rigide	rohr	tubo rígido
30 05863700	2 NR	perno supporto cesto (fornito a ricambio assemblato al tubo 05863600)	pin holder basket (spare parts provided assembled with tube 05863600)	goujon	zapfen	pernio
31 06665000	2 NR	fune	cable	câble	seil	cable
32 07052900	1 NR	staffa	bracket	étrier	haltebügel	estribo
33 359442J0	1 NR	supporto	support	support	halterung	soporte
34 05618700	1 NR	coperchio	box	couvercle	deckel	tapa
34 056187H3	1 NR	coperchio	box	couvercle	deckel	tapa
35 17360000	1 NR	cesto biposto gl1780-x17j con protezione radio in alluminio (solo per ricambio e non provvisto di adesivi)	two person basket for gl1780-x17j with protection radio aluminum (only for parts and not fitted with adhesive)	biposto panier protection gl1780-x17j avec radio en aluminium	tandem warenkorb gl1780-x17j schutz mit radio aluminium	tandem drum gl1780-x17j protección con radio de aluminio
35 27326900	1 NR	cesto biposto	basket 2 person	panier biposto	basket für 2 sitze	cesta de 2 plazas





 SUPPORTO CESTO
HALTERUNG ARBEITSKORB 
 BASKET SUPPORT
SOPORTE CESTA 
 PANIER CUPPORT

POS Codice	Q.tà	 Descrizione	 Description	 Designation	 Benennung	 Descripcìon
36 058600H3	1 NR	piastra	plate	platine	platte	placa
37 36585800	1 NR	scaletta	ladder	échelle repliable	leiter	escalera plegable
38 05475900	2 NR	antivibrante	anti-vibrating	anti - vibrant	vibrationsdämpfer	antivibrante
39 06598500	1 NR	fune	cable	câble	seil	cable
40 06585900	2 NR	rotellina	small roller	roulette	rädchen	ruedecilla
41 07298800	1 NR	chiave per serratura postazione comando a terra	key to the lock on the ground control position	clef	chlüssel	clave
41 16602500	1 NR	protezione	protection	protection	schutz	protección
42 07031800	2 NR	tubo	pipe	tuyau	rohr	tubo
43 06418600	1 NR	protezione	protection	protection	schutz	protección
44 06412400	1 NR	lamiera piegata	folded plate	tôle pliée	blech gebogen	chapa doblada
45 07190600	1 NR	copertura supporto telecomando (solo macchine modello jp e ja e x17j)	cover support remote control (only machines model jp and ja and x17j)	couverture support de la telecommande	cover fernbedienungshalter	cubierta soporte de control remoto
46 07190500	1 NR	piegato bloccaggio telecomando (solo macchine modello jp e ja e x17j)	bended locking remote control (only machines model jp and ja and x17j)	bent blocage telecommande	bent einrasten fernbedienung	bent bloqueo de control remoto

 SUPPORTO CESTO

 HALTERUNG ARBEITSKORB 
 BASKET SUPPORT

 SOPORTE CESTA 
 PANIER CUPPORT

POS Codice	Q.tà	 Descrizione	 Description	 Designation	 Benennung	 Descripción
47 07190800	1 NR	staffa fissaggio chiusura bloccaggio telecomando (solo macchine modello jp e ja e x17j)	bracket locking remote control (only machines model jp and ja and x17j)	fin de support de blocage telecommande	bracket end einrasten fernbedienung	soporte de fin de bloqueo de control remoto
48 07192700	1 NR	chiusura a volantino con leva piegata (solo macchine modello jp e ja e x17j)	locking wheel with bent lever (only machines model jp and ja and x17j)	fin de support de blocage telecommande	bracket end einrasten fernbedienung	soporte de fin de bloqueo de control remoto
49 07239800	1 NR	piastra fissaggio cesto (solo macchine modello jp e ja e x17j)	fixing plate basket (only machines model jp and ja and x17j)	plate fixation drum	plate befestigung drum	placa fijación tambor
49 07239800	2 NR	piastra fissaggio cesto (solo macchine modello jp e ja e x17j)	fixing plate basket (only machines model jp and ja and x17j)	plate fixation drum	plate befestigung drum	placa fijación tambor
50 07239700	2 NR	distanziale per viti m8 supporto cesto (solo macchine modello jp e ja e x17j)	spacer screw m8 support basket (only machines model jp and ja and x17j)	spacer par vis	spacer per schrauben	separador por tornillos
53 06895900	1 NR	piastra	plate	platine	platte	placa







 ACCOPPIAMENTO MOTORE DIESEL- POMPA

PUMPEN / DIESELMOTOR KUPPLUNG 

 DIESEL ENGINE COUPLING - PUMP

ACOPLAMIENTO MOTOR DIESEL- BOMBA 

 ACCOUPLEMENT MOTEUR DIESEL - POMPE

POS Codice	Q.tà	 Descrizione	 Description	 Designation	 Benennung	 Descripción
1 04310200	1 NR	semigiunto	half coupling	demi-joint	halbverbindung	semi-acoplamiento
2 04310100	1 NR	inserto in gomma	rubber insert	insert en caoutchouc	gummieinsatz	inserto de goma
3 04615300	1 NR	giunto	coupling	joint	verbindung	acoplamiento
4 04310300	1 NR	lanterna	lantern	lanterne	buchse	linterna
5 25526300	1 NR	pompa idraulica	hydraulic pump	pompe hydraulique	hydraulikpumpe	bomba hidráulica
6 04152400	4 NR	antivibrante versione diesel	anti-vibrating diesel version	anti - vibrant	vibrationsdämpfer	antivibrante
6 05535300	4 NR	antivibrante versione benzina	anti-vibrating gasoline version	anti - vibrant	vibrationsdämpfer	antivibrante
7 05955100	2 NR	piatto	plate	plateau	platte	placa
8 25952600	1 NR	motore benzina	petrol engine	moteur a essence	benzinmotor	motor de gasolina
9 06117700	1 NR	staffa	bracket	étrier	haltebügel	estribo
10 05922000	1 NR	deflettore	deflector	défecteur	abweiser	deflector
11 27110400	1 NR	motore diesel hatz 10hp versione con predisposizione regolazioni giri elettronica (no carb-epa cert)	hatz diesel engine 10hp version with predisposition to electronic speed regulation (no carb-epa cert)	moteur diesel	dieselmotor	motor diesel







 ACCOPPIAMENTO MOTORE DIESEL- POMPA

PUMPEN / DIESELMOTOR KUPPLUNG 

 DIESEL ENGINE COUPLING - PUMP

ACOPLAMIENTO MOTOR DIESEL- BOMBA 

 ACCOUPLEMENT MOTEUR DIESEL - POMPE

POS Codice	Q.tà	 Descrizione	 Description	 Designation	 Benennung	 Descripcìon
12 2558630001	1 NR	accoppiamento motore - pompa	engine coupling - pump	accouplement moteur - pompe	pumpen-/motorkupplung	acoplamiento motor - bomba
13 05559100	1 NR	distanziale	spacer	entretoise	distanzstück	distanciador
14 07098900	1 NR	staffa	bracket	étrier	haltebügel	haltebügel
15 26514900	1 NR	sensore	sensor	capteur	sensor	sensor
16 05790000	2 NR	piatto	plate	plateau	platte	placa
17 07098600	1 NR	perno	pin	goujon	zapfen	pernio
18 07098700	1 NR	tirante	tie rod	tirant	turmgestänge	tirante
19 26551500	1 NR	pistone	piston	piston	kolben	pistón
20 06190700	1 NR	protezione	protection	protection	schutz	protección

 RICAMBI MOTORE

MOTORERSATZTEILE 

 ENGINE SPARE PARTS

REPUESTOS MOTOR 



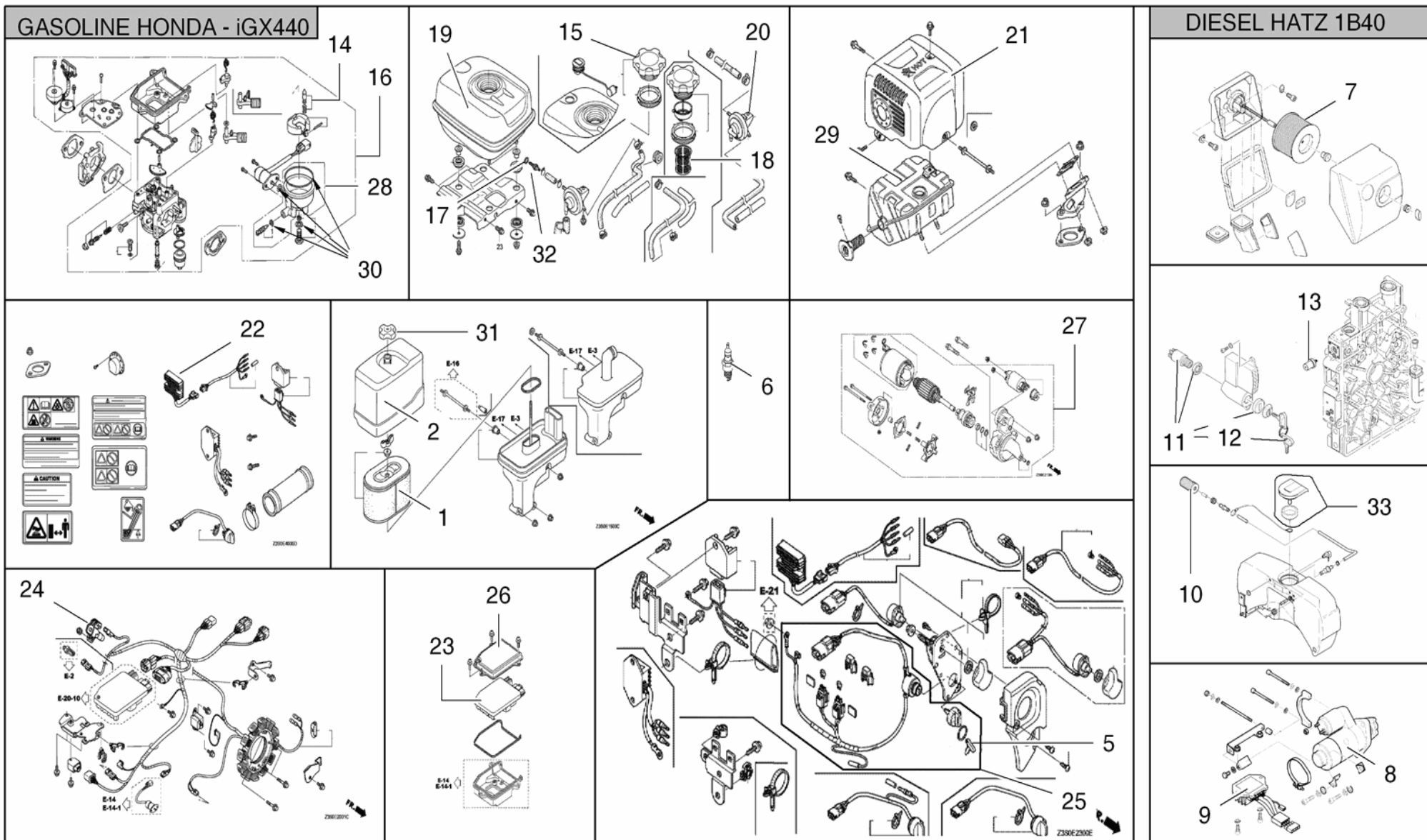

 PIÈCES DÉTACHÉES DU MOTEUR



 RICAMBI MOTORE

 MOTORERSATZTEILE 
 ENGINE SPARE PARTS

 REPUESTOS MOTOR 
 PIÈCES DÉTACHÉES DU MOTEUR

POS Codice	Q.tà	 Descrizione	 Description	 Designation	 Benennung	 Descripción
1 2595260001	1 NR	filtro aria	air filter	filter à air	luftfilter	filtro aire
2 2595260002	1 NR	coperchio	cover	couvercle	deckel	tapa
5 2595260003	1 NR	chiave accensione motore	key ignition engine	clé moteur d'allumage	zündungsschalter engine	motor llave
6 2595260004	1 NR	candela accensione	sparking plug	bougie électrique	zündkerze	bujía encendido
7 2625560002	1 NR	filtro aria	air filter	filter à air	luftfilter	filtro aire
8 2558630004	1 NR	motorino avviamento	starter motor	démarrreur	anlasser	motor de arranque
9 2558630005	1 NR	regolatore di tensione	voltage regulator	régulateur de tension	spannungsregler	regulador de tensión
9 2558630009	1 NR	regolatore di corrente hatz modello ducati	current regulator hatz ducati model	régulateur de tension moteur hatz	hydraulischer antrieb	comando hidráulico
10 2558630003	1 NR	filtro gasolio	gas oil filter	filtre à gasoil	kraftstofffilter	filtro gasóleo
11 2631430001	1 NR	blocchetto chiave	block	bloc	block	bloque
12 2631430002	1 NR	chiave accensione	ignition key	clef de démarrage	zündschlüssel	clave de encendido
13 2558630008	1 NR	solenoide	solenoid	solenoïde	solenoid	solenoide
14 2558640008	1 NR	spillo	spillo	aiguille	nadel	aguja
15 2558640012	1 NR	tappo serbatoio benzina	fuel tank cap	bouchon reservoir carburant	tankdeckel	tanque cap





 RICAMBI MOTORE

 MOTORERSATZTEILE

 ENGINE SPARE PARTS

 REPUESTOS MOTOR





 PIÈCES DÉTACHÉES DU MOTEUR

POS Codice	Q.tà	 Descrizione	 Description	 Designation	 Benennung	 Descripción
16 2595260005	1 NR	carburatore per igx440	carburetor for igx440	carburateur pour igx440	vergaser für igx440	carburador para igx440
17 2558640031	1 NR	o-ring per filtro benzina	o-ring for fuel filter	o-ring pour filtre a carburant	o-ring für kraftstoff filter	anillo de filtro de combustible
18 2595260006	1 NR	filtro benzina serbatoio	filter fuel tank	reservoir de carburant filtre	filter fuel tank	tanque de combustible filtro
19 2595260008	1 NR	serbatoio benzina igx440iu	fuel tank igx440iu	reservoir de carburant igx440iu	fuel tank igx440iu	tanque de combustible igx440iu
20 2595260007	1 NR	assieme rubinetto automatico carburante	automatic fuel valve assembly	robinet automatique	automatischer wasserhahn	grifo automático
21 2595260009	1 NR	protezione marmitta honda igx440	protection muffler honda igx440	protection d'echappement	hitzeschutzgitter	protección del silenciador
22 2595260012	1 NR	regolatore motori honda igx440	regulator honda motors igx440	regulateur	regulator	regulador
23 2595260013	1 NR	scheda carburatore gx440	board carburetor gx440	carte de carburant	tankkarte	tarjeta de combustible
24 2595260024	1 NR	bobina accensione motore igx440	ignition coil motor igx440	bobine d'allumage moteur igx440	zündspule motor igx440	bobina motor igx440
25 2595260015	1 NR	assieme interuttori motore igx440 da matricola motore n°1002823	motor assembly switches igx440 from engine serial n ° 1002823	commutateurs moteur igx440	schalter motor igx440	interruptores motor igx440

 RICAMBI MOTORE

 MOTORERSATZTEILE 
 ENGINE SPARE PARTS

 REPUESTOS MOTOR 
 PIÈCES DÉTACHÉES DU MOTEUR

POS Codice	Q.tà	 Descrizione	 Description	 Designation	 Benennung	 Descripción
26 2595260014	1 NR	coperchio carburetor gx440	cover carburetor gx440	cover carburateur gx440	cover vergaser gx440	cubierta carburador gx440
27 2595260025	1 NR	motorino avviamento motore honda igx440	starter motor honda igx440	starter motor honda igx440	starter motor honda igx440	motor honda igx440
28 2595260027	1 NR	vaschetta carburetor	tank carburator	tanque de combustível	fuel tank	tanque de combustible
29 2595260028	1 NR	marmitta per honda 440	silencer for honda 440	silencieux pour honda 440	muffler für honda 440	silenciador para honda 440
30 2595260026	1 NR	kit guarnizioni carburetor	carburetor gasket kit	carburetor trousse de joint	vergaserdichsatz kit	carburetor kit de juntas
31 2595260029	1 NR	dado per coperchio filtro aria	nut for air filter cover	nut pour filtre a air cover	nut for luftfilterdeckel	tuerca de filtro de aire cubierta
32 2598600002	1 NR	raccordo per serbatoio	fitting for tank	montage de réservoir	passend für tank	montaje de tanque
33 2631430004	1 NR	tappo serbatoio gasolio	fuel tank cap	bouchon réservoir gasoil hatz 1b30-1b40	tankdeckel	tapa depósito gasoil

 MOTORE ELETTRICO

E-MOTOR 



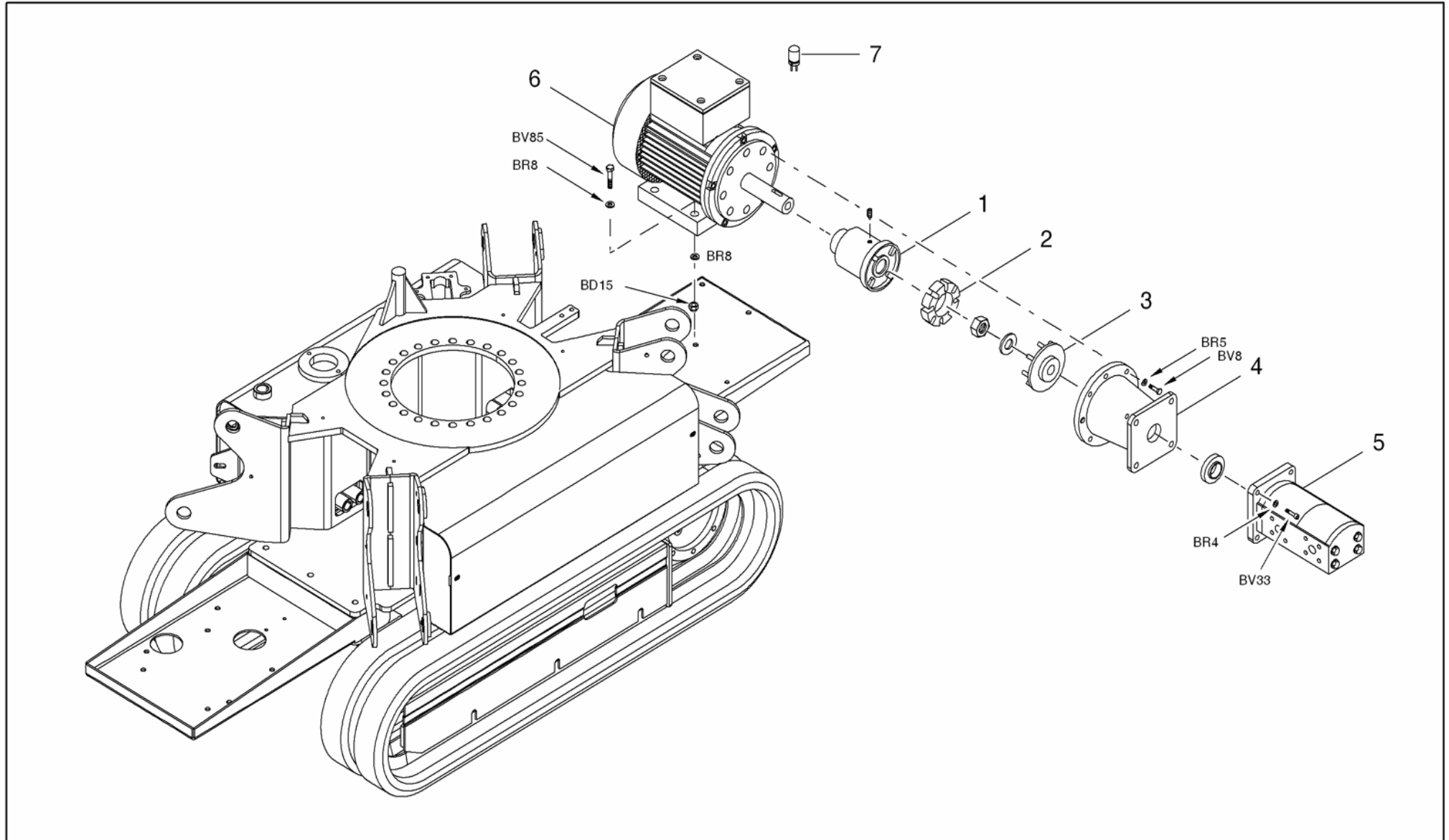

 ELECTRIC MOTOR

MOTOR ELÉCTRICO 

 MOTEUR ÉLECTRIQUE



 MOTORE ELETTRICO
E-MOTOR 
 ELECTRIC MOTOR
MOTOR ELÉCTRICO 
 MOTEUR ÉLECTRIQUE

POS	Codice	Q.tà	 Descrizione	 Description	 Designation	 Benennung	 Descripción
1	05563400	1 NR	semigiunto versione motore elettrico standard	half coupling electric motor standard version	demi-joint	halbverbindung	semi-acoplamiento
1	06997800	1 NR	semigiunto versione litio	half coupling lithium version	demi-joint	halbverbindung	semi-acoplamiento
2	04310100	1 NR	inserto in gomma	rubber insert	insert en caoutchouc	gummieinsatz	inserto de goma
3	04615300	1 NR	giunto	coupling	joint	verbindung	acoplamiento
4	05510200	1 NR	lanterna	lantern	lanterne	buchse	linterna
5	25526300	1 NR	pompa idraulica	hydraulic pump	pompe hydraulique	hydraulikpumpe	bomba hidráulica
6	25510100	1 NR	motore elettrico 230v 50hz	electric motor 230v 50hz	moteur électrique 230v 50hz	e-motor 230v 50hz	motor eléctrico 230v 50hz
6	26774500	1 NR	motore elettrico lithium 2kw	electric motor lithium 2kw	moteur électrique	e-motor	motor eléctrico
7	2551010001	1 NR	condensatore 230v mf80 d=55	condenser 230v mf80 d=55	condensateur	kondensator	condensador

 IMPIANTO IDRAULICO MANDATE E SCARICO

HYDRAULIKANLAGE VORLÄUFE UND RÜCKLAUF 

 SUPPLY AND DISCHARGE HYDRAULIC SYSTEM

INSTALCIÓN HIDRÁULICA IMPULSIONES Y DESCARGA 

 SYSTÈME HYDRAULIQUE REFOULEMENT ET DÉCHARGEME

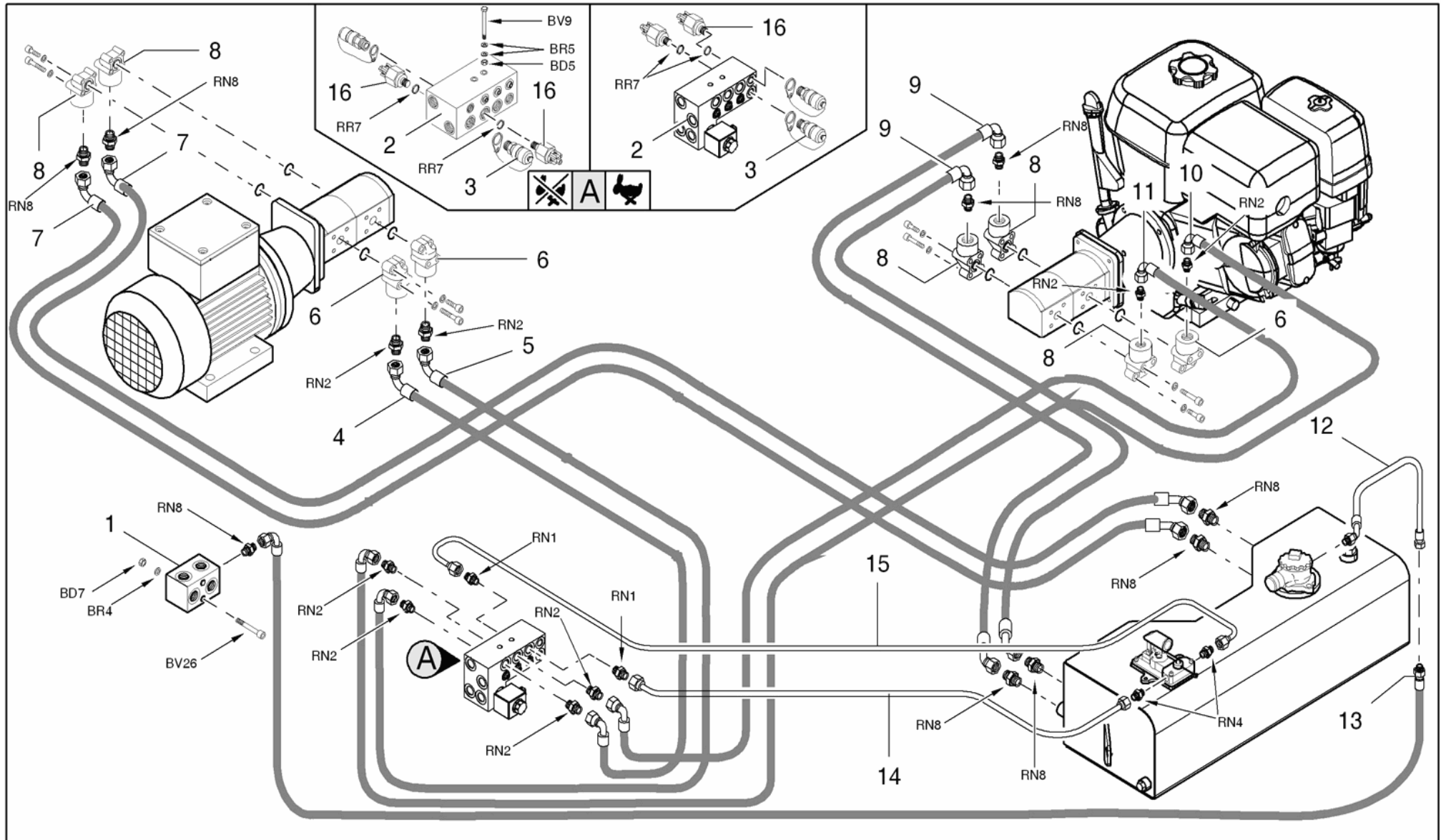







 IMPIANTO IDRAULICO MANDATE E SCARICO

 HYDRAULIKANLAGE VORLÄUFE UND RÜCKLAUF 
 SUPPLY AND DISCHARGE HYDRAULIC SYSTEM

 INSTALACIÓN HIDRÁULICA IMPULSIONES Y DESCARGA 
 SYSTÈME HYDRAULIQUE REFOULEMENT ET DÉCHARGEME

POS Codice	Q.tà	 Descrizione	 Description	 Designation	 Benennung	 Descripción
1 05497500	1 NR	blocchetto tubi	hoses block	bloc tuyaux	rohrblock	bloque tubos
2 15496200	1 NR	valvola idraulica mandate singola velocità	hydraulic valve outlet single speed	valve hydraulique	ventil	válvula hidráulica
2 15659500	1 NR	valvola idraulica 2 velocità	hydraulic valve high speed	valve hydraulique	valve hydraulique	válvula hidráulica
3 03014400	2 NR	prova pressione 1/4" g	pressure test 1/4" g	preuve pression 1/4" g	druckkontrolle 1/4" g	prueba presión 1/4" g
4 06892600	1 NR	tubo flessibile	flexible pipe	tuyau flexible	schlauch	tubo flexible
5 06892700	1 NR	tubo flessibile	flexible pipe	tuyau flexible	schlauch	tubo flexible
6 04048100	2 NR	flangia 3/8" g	flange 3/8" g	bride 3/8" g	flansch 3/8" g	brida 3/8" g
7 06892500	2 NR	tubo flessibile	flexible pipe	tuyau flexible	schlauch	tubo flexible
8 04845400	2 NR	flangia 1/2" g	flange 1/2" g	bride 1/2" g	flansch 1/2" g	brida 1/2" g
9 06047800	2 NR	tubo flessibile	flexible pipe	tuyau flexible	schlauch	tubo flexible
10 06048000	1 NR	tubo flessibile	flexible pipe	tuyau flexible	schlauch	tubo flexible
11 06048100	1 NR	tubo flessibile	flexible pipe	tuyau flexible	schlauch	tubo flexible
12 06030100	1 NR	tubo rigido	rigid pipe	tuyau rigide	rohr	tubo rígido
13 06892800	1 NR	tubo flessibile	flexible pipe	tuyau flexible	schlauch	tubo flexible
14 06030000	1 NR	tubo rigido	rigid pipe	tuyau rigide	rohr	tubo rígido





 IMPIANTO IDRAULICO MANDATE E SCARICO

HYDRAULIKANLAGE VORLÄUFE UND RÜCKLAUF 

 SUPPLY AND DISCHARGE HYDRAULIC SYSTEM

INSTALACIÓN HIDRÁULICA IMPULSIONES Y DESCARGA 

 SYSTÈME HYDRAULIQUE REFOULEMENT ET DÉCHARGEME

POS Codice	Q.tà	 Descrizione	 Description	 Designation	 Benennung	 Descripción
15 07097300	1 NR	tubo rigido	rigid pipe	tuyau rigide	rohr	tubo rígido
16 26964400	2 NR	pressostato	pressure switch	pression	druckwächter	presión

 IMPIANTO IDRAULICO MANDATE E SCARICO

HYDRAULIKANLAGE VORLÄUFE UND RÜCKLAUF 



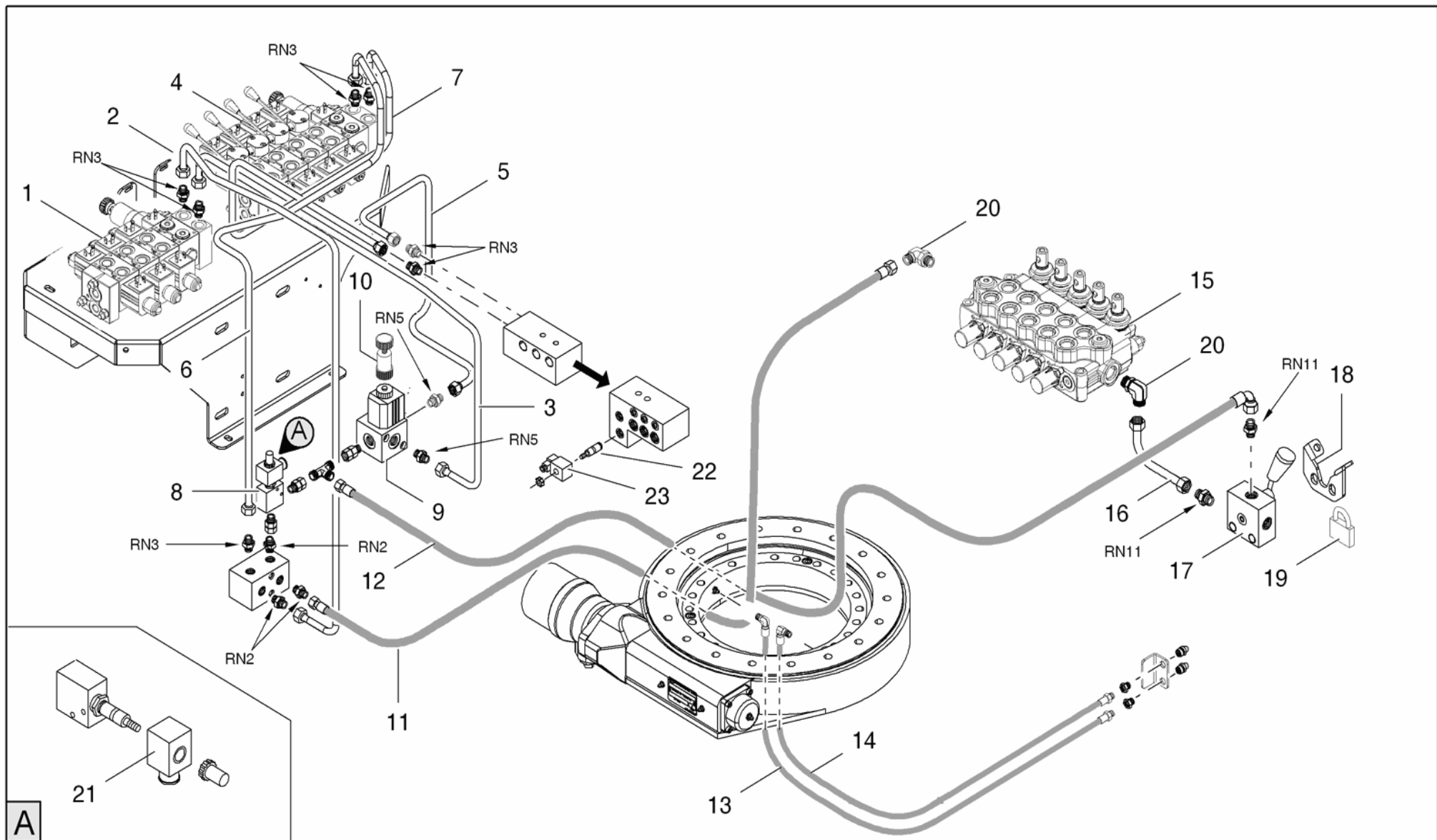

 SUPPLY AND DISCHARGE HYDRAULIC SYSTEM

INSTALACIÓN HIDRÁULICA IMPULSIONES Y DESCARGA 

 SYSTÈME HYDRAULIQUE REFOULEMENT ET DÉCHARGEMENT



 IMPIANTO IDRAULICO MANDATE E SCARICO
HYDRAULIKANLAGE VORLÄUFE UND RÜCKLAUF 
 SUPPLY AND DISCHARGE HYDRAULIC SYSTEM
INSTALACIÓN HIDRÁULICA IMPULSIONES Y DESCARGA 
 SYSTÈME HYDRAULIQUE REFOULEMENT ET DÉCHARGEMENT

POS Codice	Q.tà	 Descrizione	 Description	 Designation	 Benennung	 Descripción
1 26458900	1 NR	distributore idraulico 3 elementi per traslazione	hydraulic distributor 3 elements to translation	distributeur hydraulique	hydr. regelsteuergerät	distribuidor hidráulico
1 27299000	1 NR	distributore lc stabilizzatori-traino 3 elementi con leve emergenza a pulsante	hydraulic distributor stabilizers-tracks 3 parts with levers emergency button	distributeur hydraulique	hydr. regelsteuergerät	distribuidor hidráulico
2 06888800	1 NR	tubo rigido	rigid pipe	tuyau rigide	rohr	tubo rígido
3 06889000	1 NR	tubo rigido	rigid pipe	tuyau rigide	rohr	tubo rígido
4 26459000	1 NR	distributore idraulico 4 elementi per traslazione	hydraulic distributor 4 sections for translation	distributeur hydraulique	hydraulisches regelsteuergerät	distribuidor hidráulico
4 27299100	1 NR	distributore lc stabilizzatori-traino 4 elementi con leve emergenza a pulsante	hydraulic distributor stabilizers-tracks 4 parts with levers emergency button	distributeur hydraulique	hydraulisches regelsteuergerät	distribuidor hidráulico
5 06890800	1 NR	tubo rigido	rigid pipe	tuyau rigide	rohr	tubo rígido
6 06888900	1 NR	tubo rigido	rigid pipe	tuyau rigide	rohr	tubo rígido
7 06890900	1 NR	tubo rigido	rigid pipe	tuyau rigide	rohr	tubo rígido
8 25509000	1 NR	elettrovalvola	solenoid valve	électrovanne	magnetventil	electroválvula
9 25732900	1 NR	deviatore idraulico	hydraulic diverter	déviateur	wechselschltter	desviador





 IMPIANTO IDRAULICO MANDATE E SCARICO

HYDRAULIKANLAGE VORLÄUFE UND RÜCKLAUF 

 SUPPLY AND DISCHARGE HYDRAULIC SYSTEM

INSTALACIÓN HIDRÁULICA IMPULSIONES Y DESCARGA 

 SYSTÈME HYDRAULIQUE REFOULEMENT ET DÉCHARGEMENT

POS Codice	Q.tà	 Descrizione	 Description	 Designation	 Benennung	 Descripción
10 25908400	1 NR	dispositivo di comando manuale idraulico	hand control hydraulic	commande hydraulique	hydraulischer antrieb	comando hidráulico
11 06892900	1 NR	tubo flessibile	flexible pipe	tuyau flexible	schlauch	tubo flexible
12 06893000	1 NR	tubo flessibile	flexible pipe	tuyau flexible	schlauch	tubo flexible
13 06049500	1 NR	tubo flessibile	flexible pipe	tuyau flexible	schlauch	tubo flexible
14 06049400	1 NR	tubo flessibile	flexible pipe	tuyau flexible	schlauch	tubo flexible
15 26900300	1 NR	distributore idraulico 5 elementi parte aerea	hydraulic distributor 5 elements aerial part	distributeur hydraulique	hydr. regelsteuergerät	distribuidor hidráulico
16 05551300	1 NR	tubo rigido	rigid pipe	tuyau rigide	rohr	tubo rígido
17 14419100	1 NR	deviatore	switch	déviateur	wechselschalter	desviador
18 05570000	1 NR	lamiera piegata	folded plate	tôle pliée	blech gebogen	chapa doblada
19 05609800	1 NR	lucchetto	padlock	cadena	vorhängeschloss	candado
20 04995000	2 NR	raccordo	fitting	raccord	anschluss	conexión
22 1647820003	1 NR	elettrovalvola	solenoid valve	électrovanne	magnetventil	electroválvula

 **DISTRIBUTORI IDRAULICI**

**HYDRAULISCHE REGELSTEUERGERÄTE** 

 **HYDRAULIC DISTRIBUTORS**

**DISTRIBUIDORES HIDRÁULICOS** 

 **DISTRIBUTEURS HYDRAULIQUES**

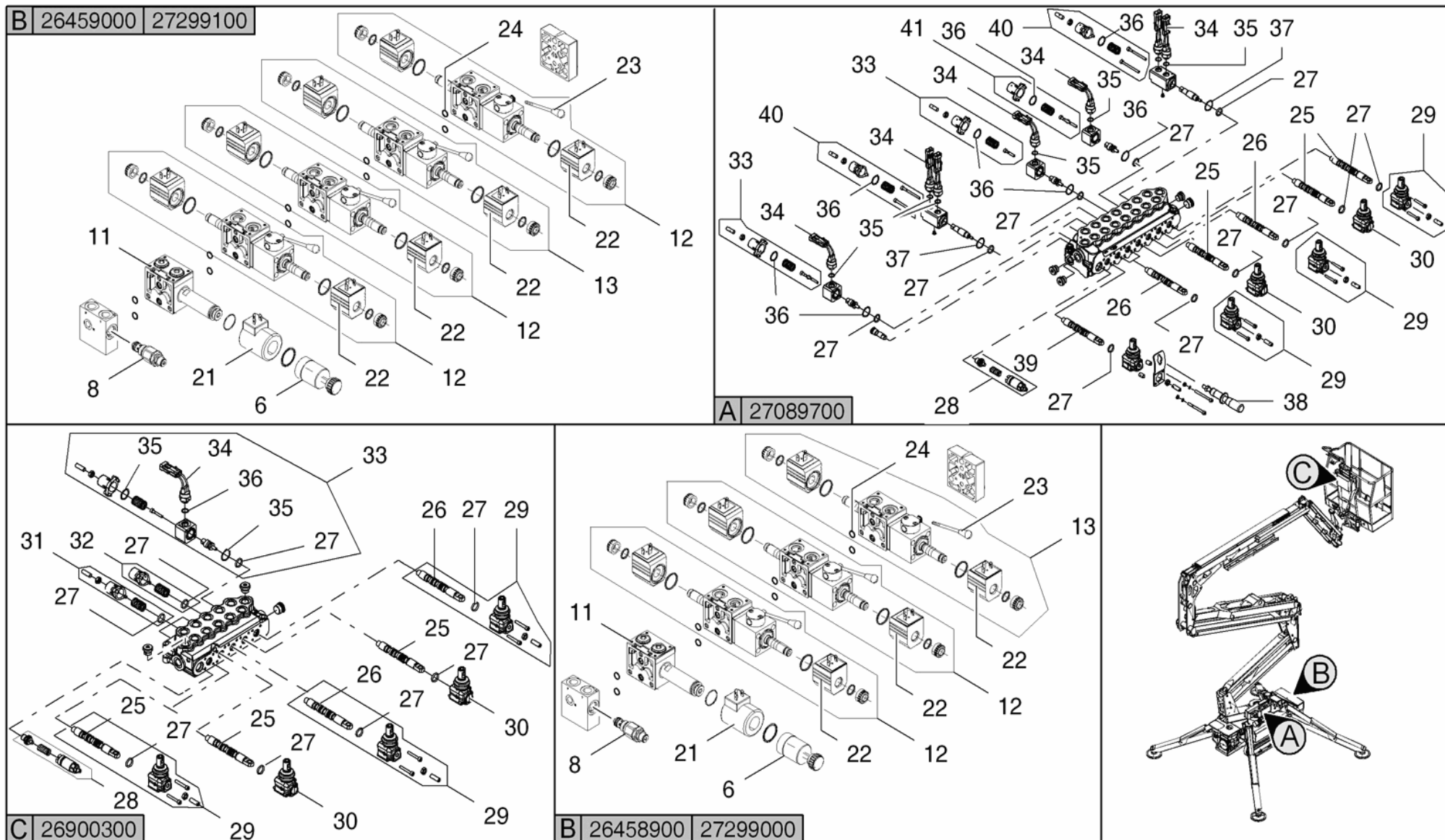





**C** 26900300

**B** 26458900 27299000





**A** 27089700

**B** 26459000 27299100

 DISTRIBUTORI IDRAULICI
HYDRAULISCHE REGELSTEUERGERÄTE 
 HYDRAULIC DISTRIBUTORS
DISTRIBUIDORES HIDRÁULICOS 
 DISTRIBUTEURS HYDRAULIQUES

POS Codice	Q.tà	 Descrizione	 Description	 Designation	 Benennung	 Descripción
6 07324900	1 NR	comando manuale emergenza con ritorno a molla	emergency maual control with spring return	commande manuel d'urgence	manuelles antrieb für notstand	mando manual de emergencia
6 2585420001	1 NR	comando manuale emergenza	emergency maual control	commande manuel d'urgence	manuelles antrieb für notstand	mando manual de emergencia
8 2645900002	1 NR	cartuccia valvola di massima pressione	cartridge pressure relief valve	cartouche huile hydr.	hydrauliköleinsatz	cartucho aceite hidr.
11 2645900007	1 NR	valvola proporzionale traini con bobina e senza comando manuale	proportional valve for track with coil and without manual override	section distributeur	regelsteuergerätab schn.	sección distribuidor
11 2729900001	1 NR	valvola proporzionale traini con bobina e senza comando manuale a molla	proportional valve for track with coil and without manual spring	valve hydraulique	hydraulikventil	vàlvula hidràulica
12 2645900005	2 NR	sezione distributore ab chiuso con leva (lato a) e bobina	section distributor ab closed with lever (side a) and coil	section distributeur	regelsteuergerätab schn.	sección distribuidor
12 2645900005	1 NR	sezione distributore ab chiuso con leva (lato a) e bobina	section distributor ab closed with lever (side a) and coil	section distributeur	regelsteuergerätab schn.	sección distribuidor
12 2645900005	3 NR	sezione distributore ab chiuso con leva (lato a) e bobina	section distributor ab closed with lever (side a) and coil	section distributeur	regelsteuergerätab schn.	sección distribuidor

 DISTRIBUTORI IDRAULICI
HYDRAULISCHE REGELSTEUERGERÄTE 
 HYDRAULIC DISTRIBUTORS
DISTRIBUIDORES HIDRÁULICOS 
 DISTRIBUTEURS HYDRAULIQUES





POS Codice	Q.tà	 Descrizione	 Description	 Designation	 Benennung	 Descripción
13 2645900006	1 NR	sezione distributore abt con leva (lato a) e bobina	section distributor abt with lever (side a) and coil	section distributeur	regelsteuergerätab schn.	sección distribuidor
21 06037100	1 NR	bobina per valvola proporzionale parte carro	coil proportional valve for undercarriage	bobine	spule	bobina
22 05913800	1 NR	bobina per on-off	coil for on-off	bobine	spule	bobina
22 05913800	8 NR	bobina per on-off	coil for on-off	bobine	spule	bobina
22 05913800	6 NR	bobina per on-off	coil for on-off	bobine	spule	bobina
23 07300200	1 NR	leva distributore	lever hydraulic distributor	levier	hebel	palanca
24 2585560005	1 NR	o-ring	o-ring	o-ring	o-ring	o-ring
25 2550970007	3 NR	cursore	cursor	curseur	cursor	cursor
26 2550970008	2 NR	cursore	cursor	curseur	cursor	cursor
26 2550970008	3 NR	cursore	cursor	curseur	cursor	cursor
27 2550970006	10 NR	o-ring	o-ring	o-ring	o-ring	o-ring
27 2550970006	14 NR	o-ring	o-ring	o-ring	o-ring	o-ring
28 2690030001	1 NR	valvola di sovrappressione	pressure relief valve	valve hydraulique	hydraulikventil	válvula hidráulica



 DISTRIBUTORI IDRAULICI

 HYDRAULISCHE REGELSTEUERGERÄTE 
 HYDRAULIC DISTRIBUTORS





 DISTRIBUIDORES HIDRÁULICOS 
 DISTRIBUTEURS HYDRAULIQUES



POS Codice	Q.tà	 Descrizione	 Description	 Designation	 Benennung	 Descripción
29 2690030003	3 NR	kit leva	lever kit	kit levier	hebelsatz	kit palanca
29 2690030003	4 NR	kit leva	lever kit	kit levier	hebelsatz	kit palanca
30 2690030002	2 NR	kit leva	lever kit	kit levier	hebelsatz	kit palanca
31 2690030004	3 NR	kit tappo con ritorno a molla e limitatore di corsa regolabile	cap kit with spring return and adjustable stroke limiter	kit bouchon fileté	abschlusskappens atz	kit tapón roscado
32 2690030005	1 NR	kit tappo con ritorno a molla	cap kit with spring return	kit bouchon fileté	abschlusskappens atz	kit tapón roscado
33 2690030006	1 NR	kit azionamento micro con ritorno a molla	micro drive kit with spring return	drive kit micro avec ressort de rappel	micro drive kit mit federrückstellung	micro kit de unidad con resorte de retorno
33 2690030006	4 NR	kit azionamento micro con ritorno a molla	micro drive kit with spring return	drive kit micro avec ressort de rappel	micro drive kit mit federrückstellung	micro kit de unidad con resorte de retorno
34 2690030009	1 NR	micro interruttore	microswitch	microinterruteur	mikroschalter	microinterruptor
34 2690030009	9 NR	micro interruttore	microswitch	microinterruteur	mikroschalter	microinterruptor
35 2690030010	1 NR	o-ring	o-ring	o-ring	o-ring	o-ring
35 2690030010	9 NR	o-ring	o-ring	o-ring	o-ring	o-ring
36 2690030011	12 NR	o-ring	o-ring	o-ring	o-ring	o-ring
36 2690030011	2 NR	o-ring	o-ring	o-ring	o-ring	o-ring



 DISTRIBUTORI IDRAULICI

 HYDRAULISCHE REGELSTEUERGERÄTE 
 HYDRAULIC DISTRIBUTORS

 DISTRIBUIDORES HIDRÁULICOS 
 DISTRIBUTEURS HYDRAULIQUES

POS Codice	Q.tà	 Descrizione	 Description	 Designation	 Benennung	 Descripción
37 2690030013	2 NR	o-ring	o-ring	o-ring	o-ring	o-ring
38 2552600009	1 NR	asta	rod	tige	stange	varilla
39 2708970001	1 NR	cursore elemento livellamento distributore	cursor element leveling distributor	curseur	cursor	cursor
40 2690030007	2 NR	kit azionamento micro con ritorno a molla	micro drive kit with spring return	drive kit micro avec ressort de rappel	micro drive kit mit federrückstellung	micro kit de unidad con resorte de retorno
41 2690030008	1 NR	kit azionamento micro con ritorno a molla	micro drive kit with spring return	drive kit micro avec ressort de rappel	micro drive kit mit federrückstellung	micro drive kit met veerteruggang

 IMPIANTO IDRAULICO TRAZIONE  
 HYDRAULIC SYSTEM FOR TRACTION  
 SYSTÈME HYDRAULIQUE DE TRACTION



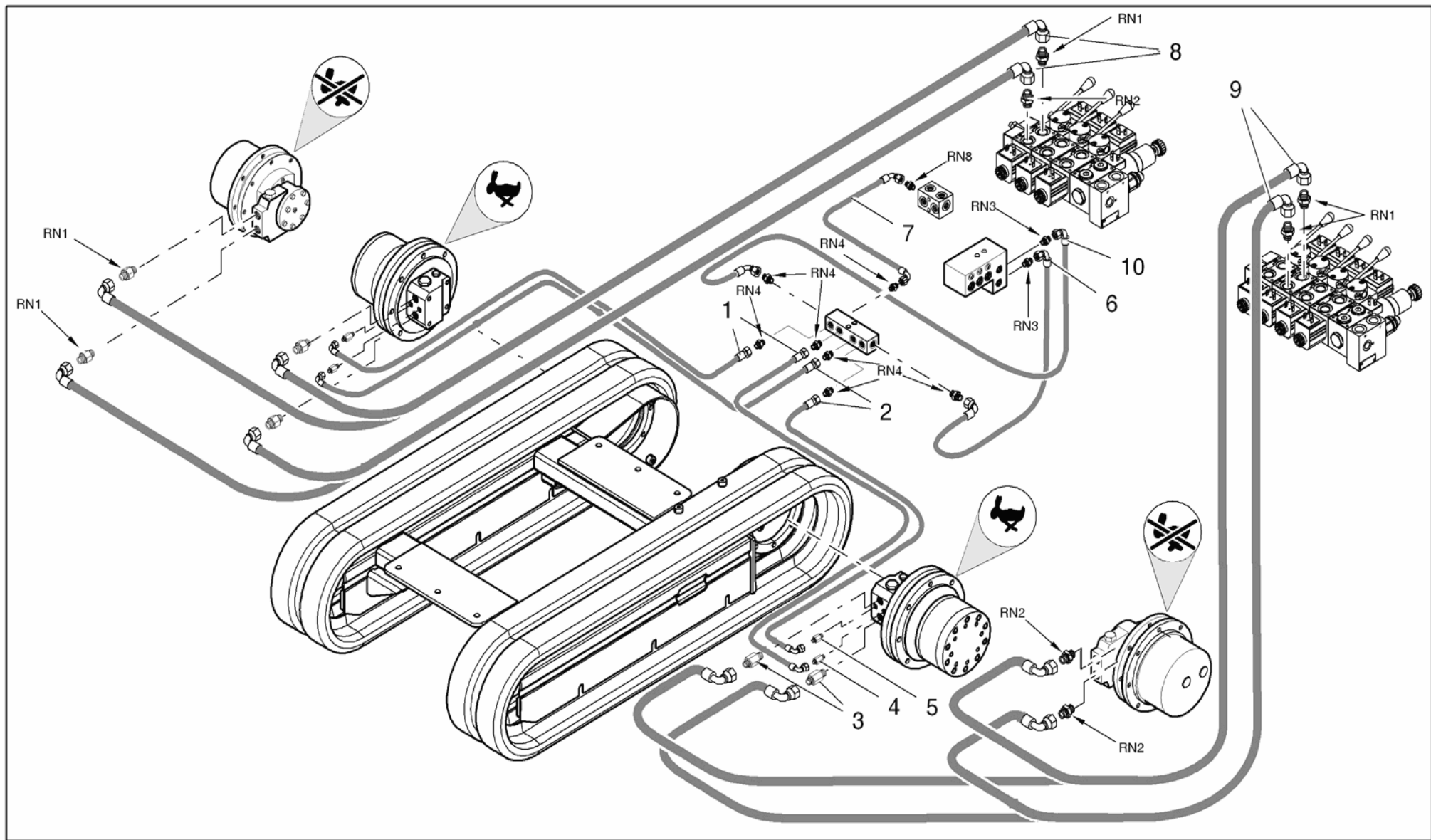

HYDRAULIKANLAGE ANTRIEB   
INSTALACIÓN HIDRÁULICA TRACCIÓN 



 IMPIANTO IDRAULICO TRAZIONE

 HYDRAULIKANLAGE ANTRIEB 
 HYDRAULIC SYSTEM FOR TRACTION

 INSTALACIÓN HIDRÁULICA TRACCIÓN 
 SYSTÈME HYDRAULIQUE DE TRACTION

POS Codice	Q.tà	 Descrizione	 Description	 Designation	 Benennung	 Descripción
1 07133800	2 NR	tubo flessibile	flexible pipe	tuyau flexible	schlauch	tubo flexible
2 07133700	2 NR	tubo flessibile	flexible pipe	tuyau flexible	schlauch	tubo flexible
3 05093900	4 NR	raccordo 12l-3/8 jis esagono 22 h40	12l-fitting 3/8 jis hex22 h40	raccord	anschluss	conexión
4 05717800	2 NR	raccordo 1/8"-8l jis h=60	fitting 1/8"-8l jis h = 60	raccord	anschluss	conexión
5 06244000	2 NR	raccordo 1/8"-8l jis h=38	fitting 1/8"-8l jis h=38	raccord	anschluss	conexión
6 07134100	1 NR	tubo flessibile	flexible pipe	tuyau flexible	schlauch	tubo flexible
7 07133900	1 NR	tubo flessibile	flexible pipe	tuyau flexible	schlauch	tubo flexible
8 06892300	2 NR	tubo flessibile	flexible pipe	tuyau flexible	schlauch	tubo flexible
9 06892200	2 NR	tubo flessibile	flexible pipe	tuyau flexible	schlauch	tubo flexible
10 07134000	1 NR	tubo flessibile	flexible pipe	tuyau flexible	schlauch	tubo flexible

 IMPIANTO IDRAULICO ALLARGAMENTO CARRO

HYDRAULIKANLAGE VERBREITERUNG WAGEN 

 HYDRAULIC SYSTEM UNDERCARRIAGE EXPANSION

INSTALACIÓN HIDRAULICA ENSANCHAMIENTO CARRO 

 SYSTÈME HYDRAULIQUE EXTENSION DU CHARIOT

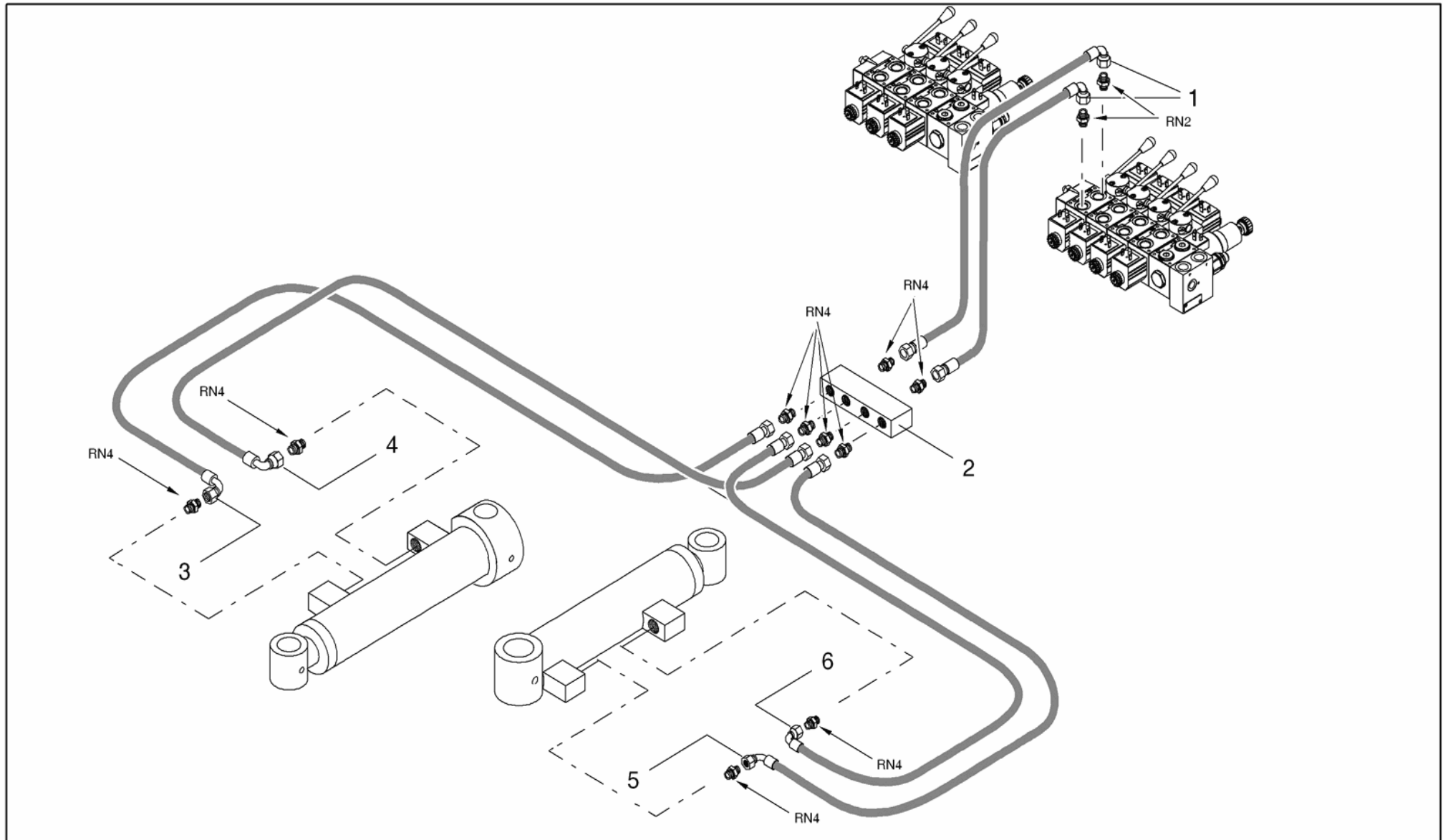





 IMPIANTO IDRAULICO ALLARGAMENTO CARRO

HYDRAULIKANLAGE VERBREITERUNG WAGEN 

 HYDRAULIC SYSTEM UNDERCARRIAGE EXPANSION

INSTALACIÓN HIDRAULICA ENSANCHAMIENTO CARRO 

 SYSTÈME HYDRAULIQUE EXTENSION DU CHARIOT

POS Codice	Q.tà	 Descrizione	 Description	 Designation	 Benennung	 Descripción
1 06892400	2 NR	tubo flessibile	flexible pipe	tuyau flexible	schlauch	tubo flexible
2 04707700	2 NR	collettore	manifold	collecteur	kollektor	colector
2 04707700	1 NR	collettore	manifold	collecteur	kollektor	colector
3 06047400	1 NR	tubo flessibile	flexible pipe	tuyau flexible	schlauch	tubo flexible
4 06047500	1 NR	tubo flessibile	flexible pipe	tuyau flexible	schlauch	tubo flexible
5 06047300	1 NR	tubo flessibile	flexible pipe	tuyau flexible	schlauch	tubo flexible
6 06047600	1 NR	tubo flessibile	flexible pipe	tuyau flexible	schlauch	tubo flexible

 IMPIANTO IDRAULICO STABILIZZATORI

ABSTÜTZUNG ABSTÜTZUNGSHYDRAULIKZYLIND 

 STABILIZERS HYDRAULIC SYSTEM

INSTALACIÓN HIDRAULICA ESTABILIZADORS 

 INSTALLATION HYDRAULIQUE STABILISATERS

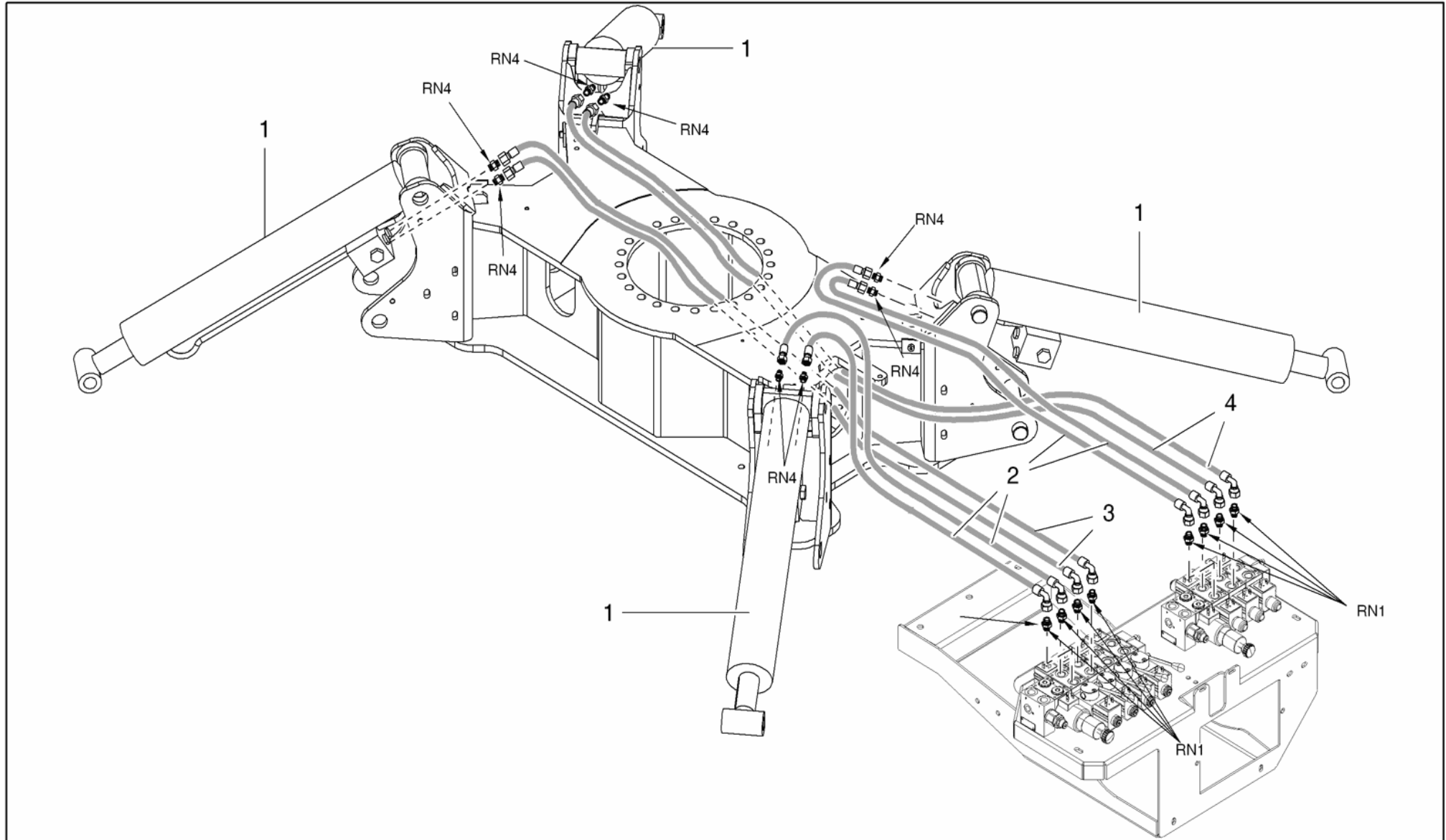





 IMPIANTO IDRAULICO STABILIZZATORI

ABSTÜTZUNG ABSTÜTZUNGSHYDRAULIKZYLIND 

 STABILIZERS HYDRAULIC SYSTEM

INSTALACIÓN HIDRAULICA ESTABILIZADORS 





 INSTALLATION HYDRAULIQUE STABILISATERS

POS Codice	Q.tà	 Descrizione	 Description	 Designation	 Benennung	 Descripcìon
1 27055400	4 NR	cilindro	cylinder	cylinder	zylinder	cilindro
2 06892000	4 NR	tubo flessibile	flexible pipe	tuyau flexible	schlauch	tubo flexible
3 06937600	2 NR	tubo flessibile	flexible pipe	tuyau flexible	schlauch	tubo flexible
4 06892100	2 NR	tubo flessibile	flexible pipe	tuyau flexible	schlauch	tubo flexible





 IMPIANTO IDRAULICO DEVIATORE-ROTAZIONE
HYDRAULIKANLAGE UMSTELLER 
 PLANT HYDRAULIC DIVERTER ROTATION
INSTALACIÓN HIDRAULICA DESVIADOR LA ROTACIÓN 
 SYSTÈME HYDRAULIQUE INVERSEUR ROTATION

POS Codice	Q.tà	 Descrizione	 Description	 Designation	 Benennung	 Descripción
1 06893100	2 NR	tubo flessibile	flexible pipe	tuyau flexible	schlauch	tubo flexible
2 06944300	1 NR	tubo flessibile	flexible pipe	tuyau flexible	schlauch	tubo flexible
3 06937700	1 NR	tubo flessibile	flexible pipe	tuyau flexible	schlauch	tubo flexible
4 06896400	1 NR	tubo flessibile	flexible pipe	tuyau flexible	schlauch	tubo flexible
5 06896300	1 NR	tubo flessibile	flexible pipe	tuyau flexible	schlauch	tubo flexible
6 06884900	1 NR	tubo rigido	rigid pipe	tuyau rigide	rohr	tubo rígido
7 06884300	1 NR	tubo rigido	rigid pipe	tuyau rigide	rohr	tubo rígido
8 06884200	1 NR	tubo rigido	rigid pipe	tuyau rigide	rohr	tubo rígido
9 06884100	1 NR	tubo rigido	rigid pipe	tuyau rigide	rohr	tubo rígido
10 06897800	1 NR	tubo flessibile	flexible pipe	tuyau flexible	schlauch	tubo flexible
11 06896700	2 NR	tubo flessibile	flexible pipe	tuyau flexible	schlauch	tubo flexible
12 06897700	1 NR	tubo flessibile	flexible pipe	tuyau flexible	schlauch	tubo flexible
13 27089700	1 NR	distributore idraulico 7 elementi parte aerea	hydraulic distributor 7 elements aerial part	distributeur hydraulique	hydr. regelsteuergerät	distribuidor hidráulico
14 06936300	2 NR	raccordo speciale 1/2" 10l ø=1,2mm	special fitting 1/2" 10l ø=1,2mm	raccord	anschluss	conexión

 IMPIANTO IDRAULICO CILINDRI 1-2-3 BRACCI

HYDRAULIKANLAGE ZYLINDER 1-2-3 ARM 

 1-2-3 ARMS CYLINDERS HYDRAULIC SYSTEM

INSTALACIÓN HIDRÁULICA CILINDROS 1-2-3 BRAZOS 



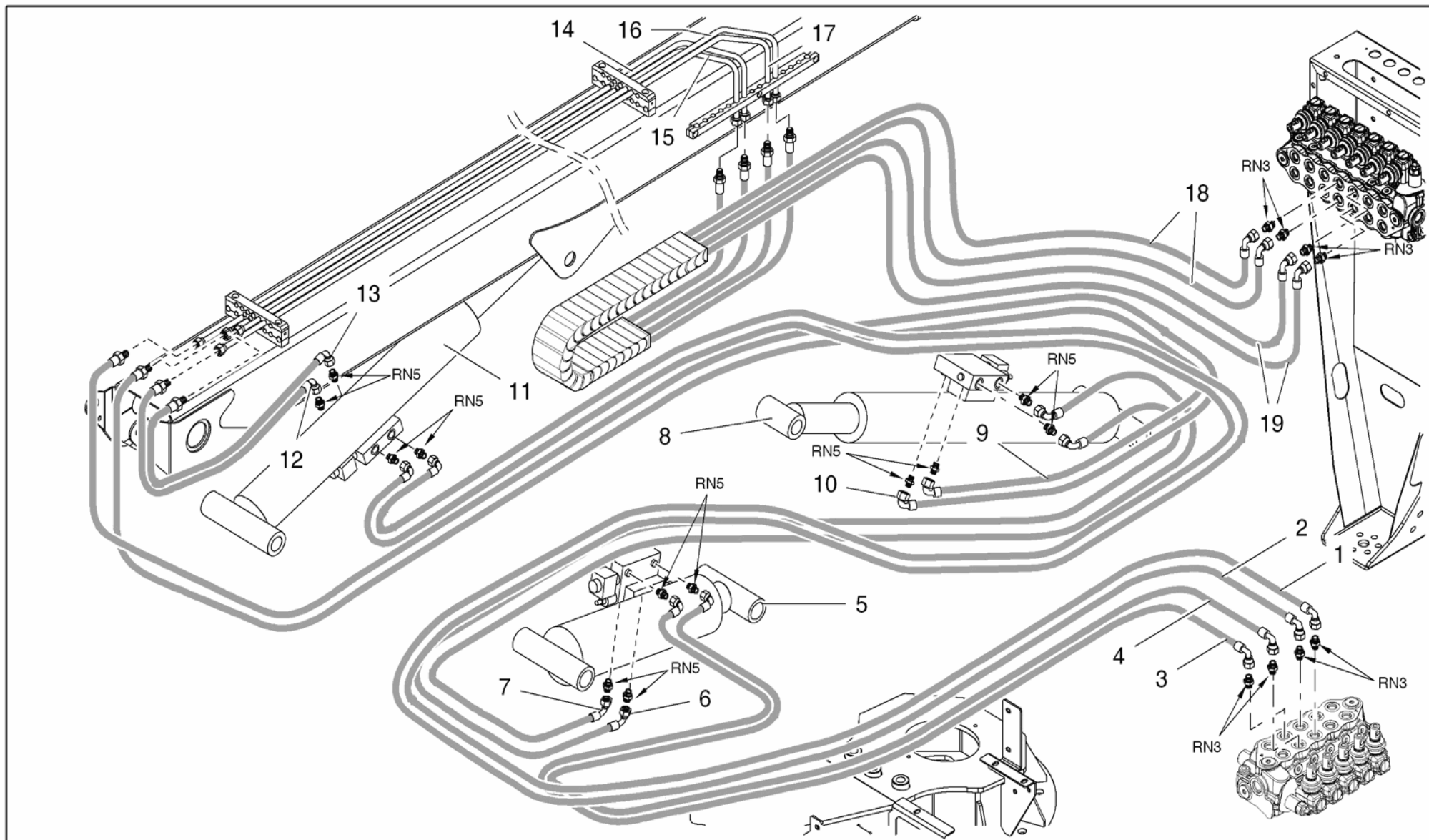

 SYSTÈME HYDRAULIQUE CYLINDRES 1-2-3 BRAS



 IMPIANTO IDRAULICO CILINDRI 1-2-3 BRACCI

 HYDRAULIKANLAGE ZYLINDER 1-2-3 ARM 
 1-2-3 ARMS CYLINDERS HYDRAULIC SYSTEM

 INSTALACIÓN HIDRÁULICA CILINDROS 1-2-3 BRAZOS 
 SYSTÈME HYDRAULIQUE CYLINDRES 1-2-3 BRAS

POS Codice	Q.tà	 Descrizione	 Description	 Designation	 Benennung	 Descripción
1 06893700	1 NR	tubo flessibile	flexible pipe	tuyau flexible	schlauch	tubo flexible
2 06893800	1 NR	tubo flessibile	flexible pipe	tuyau flexible	schlauch	tubo flexible
3 06893200	1 NR	tubo flessibile	flexible pipe	tuyau flexible	schlauch	tubo flexible
4 06893300	1 NR	tubo flessibile	flexible pipe	tuyau flexible	schlauch	tubo flexible
5 26835700	1 NR	cilindro primo braccio	cylinder first arm	cylindre première bras	zylinder erste arm	cilindro primera el brazo
6 06893400	1 NR	tubo flessibile	flexible pipe	tuyau flexible	schlauch	tubo flexible
7 06893500	1 NR	tubo flessibile	flexible pipe	tuyau flexible	schlauch	tubo flexible
8 26835800	1 NR	cilindro secondo braccio	cylinder second arm	cylindre deuxième bras	zylinder zweite arm	cilindro segundo brazo
9 06893600	1 NR	tubo flessibile	flexible pipe	tuyau flexible	schlauch	tubo flexible
10 06996300	1 NR	tubo flessibile	flexible pipe	tuyau flexible	schlauch	tubo flexible
11 26835900	1 NR	cilindro terzo braccio	third arm cylinder	cylindre troisième bras	zylinder dritten arm	cilindro tercero brazo
12 06893900	1 NR	tubo flessibile	flexible pipe	tuyau flexible	schlauch	tubo flexible
13 06937800	1 NR	tubo flessibile	flexible pipe	tuyau flexible	schlauch	tubo flexible
14 06884700	1 NR	tubo rigido	rigid pipe	tuyau rigide	rohr	tubo rígido
15 06884600	1 NR	tubo rigido	rigid pipe	tuyau rigide	rohr	tubo rígido





 IMPIANTO IDRAULICO CILINDRI 1-2-3 BRACCI

HYDRAULIKANLAGE ZYLINDER 1-2-3 ARM 

 1-2-3 ARMS CYLINDERS HYDRAULIC SYSTEM

INSTALACIÓN HIDRÁULICA CILINDROS 1-2-3 BRAZOS 

 SYSTÈME HYDRAULIQUE CYLINDRES 1-2-3 BRAS

POS Codice	Q.tà	 Descrizione	 Description	 Designation	 Benennung	 Descripción
16 06885200	1 NR	tubo rigido	rigid pipe	tuyau rigide	rohr	tubo rígido
17 06885100	1 NR	tubo rigido	rigid pipe	tuyau rigide	rohr	tubo rígido
18 06896800	2 NR	tubo flessibile	flexible pipe	tuyau flexible	schlauch	tubo flexible
19 06896900	2 NR	tubo flessibile	flexible pipe	tuyau flexible	schlauch	tubo flexible

 IMPIANTO IDRAULICO SFILO-JIB-ARIA

PFLANZE HYDRAULISCHE ERWEITERUNG AUSLEGER LUFT 

 TELESCOPIC-JIB-COMPRESSED AIR HYDRAULIC SYSTEM

PLANTA HIDRÁULICA EXTENSIÓN JIB AIRE 

 SYSTÈME HYDRAULIQUE TELESCOPIQUE-JIB-AIR COMPRIM

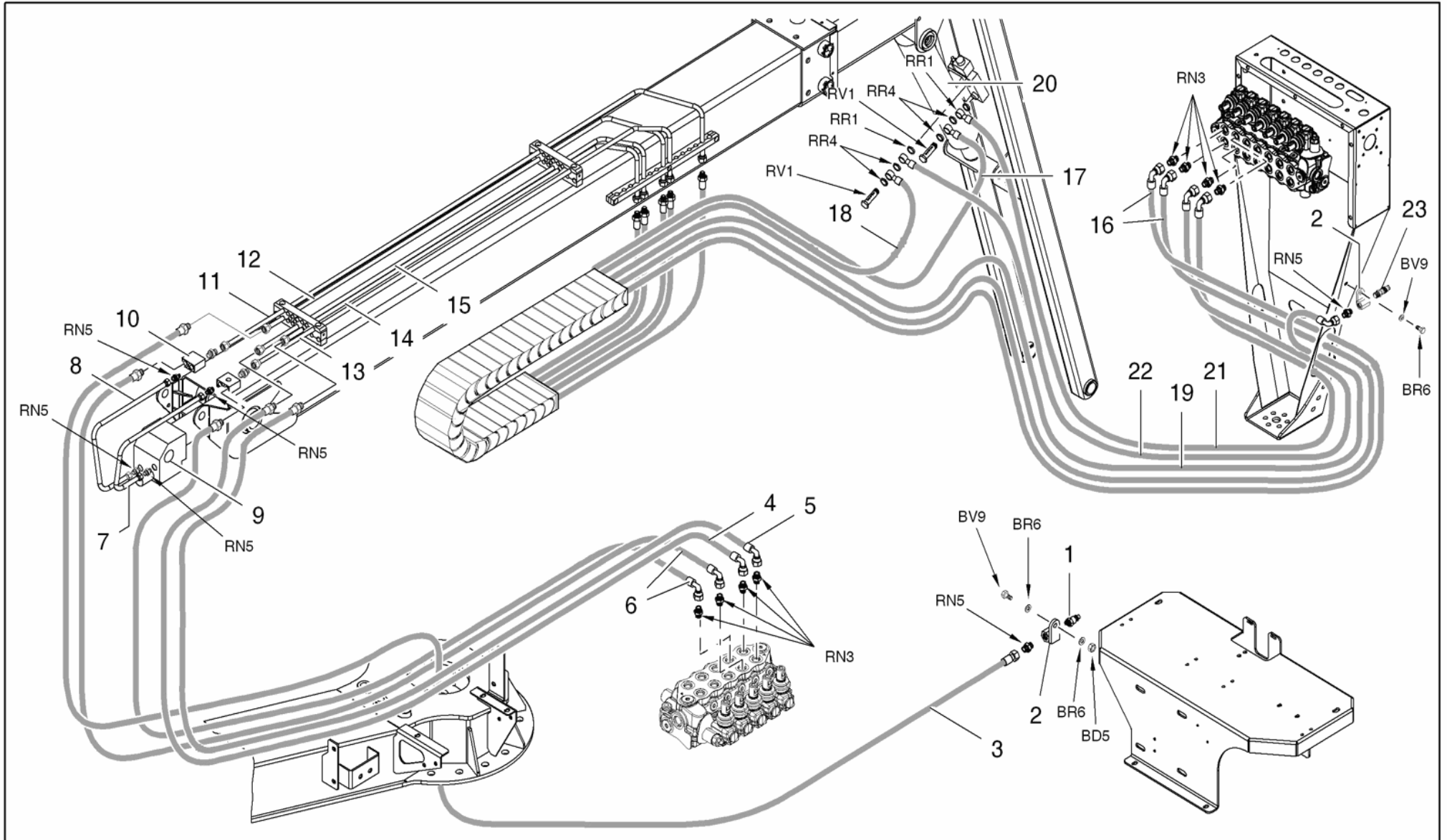





 IMPIANTO IDRAULICO SFILO-JIB-ARIA

 PFLANZE HYDRAULISCHE ERWEITERUNG AUSLEGER LUFT

 TELESCOPIC-JIB-COMPRESSED AIR HYDRAULIC SYSTEM

 PLANTA HIDRÁULICA EXTENSIÓN JIB AIRE

 SYSTÈME HYDRAULIQUE TELESCOPIQUE-JIB-AIR COMPRIM

POS Codice	Q.tà	 Descrizione	 Description	 Designation	 Benennung	 Descripcìon
1 05509900	1 NR	innesto rapido	quick coupling	raccord rapide	schnellkupplung	conexión rápida
2 04845100	1 NR	supporto	support	support	halterung	soporte
3 06896100	1 NR	tubo flessibile	flexible pipe	tuyau flexible	schlauch	tubo flexible
4 06894000	1 NR	tubo flessibile	flexible pipe	tuyau flexible	schlauch	tubo flexible
5 06937900	1 NR	tubo flessibile	flexible pipe	tuyau flexible	schlauch	tubo flexible
6 06896200	2 NR	tubo flessibile	flexible pipe	tuyau flexible	schlauch	tubo flexible
7 06900100	1 NR	tubo rigido	rigid pipe	tuyau rigide	rohr	tubo rígido
8 06900200	1 NR	tubo rigido	rigid pipe	tuyau rigide	rohr	tubo rígido
9 26836000	1 NR	cilindro sfilo	extension cylinder	cylindre sect.télescop.	teleskopzylinder	cil. brazo telescóp.
10 06900000	2 NR	blocchetto	block	bloc	block	bloque
11 06885500	1 NR	tubo rigido	rigid pipe	tuyau rigide	rohr	tubo rígido
12 06884800	1 NR	tubo rigido	rigid pipe	tuyau rigide	rohr	tubo rígido
13 06885000	1 NR	tubo rigido	rigid pipe	tuyau rigide	rohr	tubo rígido
14 06884400	1 NR	tubo rigido	rigid pipe	tuyau rigide	rohr	tubo rígido
15 06884500	1 NR	tubo rigido	rigid pipe	tuyau rigide	rohr	tubo rígido
16 06897300	2 NR	tubo flessibile	flexible pipe	tuyau flexible	schlauch	tubo flexible





 IMPIANTO IDRAULICO SFILO-JIB-ARIA

PFLANZE HYDRAULISCHE ERWEITERUNG AUSLEGER LUFT 

 TELESCOPIC-JIB-COMPRESSED AIR HYDRAULIC SYSTEM

PLANTA HIDRÁULICA EXTENSIÓN JIB AIRE 

 SYSTÈME HYDRAULIQUE TELESCOPIQUE-JIB-AIR COMPRIM

POS Codice	Q.tà	 Descrizione	 Description	 Designation	 Benennung	 Descripción
17 06938000	1 NR	tubo flessibile	flexible pipe	tuyau flexible	schlauch	tubo flexible
18 06897000	1 NR	tubo flessibile	flexible pipe	tuyau flexible	schlauch	tubo flexible
19 06897900	1 NR	tubo flessibile	flexible pipe	tuyau flexible	schlauch	tubo flexible
20 26853300	1 NR	cilindro jib	jib cylinder	cylindre fléchette	schwenkarmhzylin- der	cilindro jib
21 06897100	1 NR	tubo flessibile	flexible pipe	tuyau flexible	schlauch	tubo flexible
22 06897200	1 NR	tubo flessibile	flexible pipe	tuyau flexible	schlauch	tubo flexible
23 05580200	1 NR	rubinetto	faucet	robinet	wasserhahn	grifo



 IMPIANTO IDRAULICO LIVELLAMENTO-ROTAZIONE CESTO

HYDRAULIKANLAGE ZYLINDER ARM-KORBSCHWENKUNG 

 LEVELING CYLINDERS-CAGE ROTATION HYDRAULIC SYSTE

INSTALACIÓN HIDRÁULICA CILINDROS BRAZOS-ROTACIÓN CESTA 

 SYSTÈME HYDRAULIQUE CYLINDRES BRAS-ROTATION PANIER

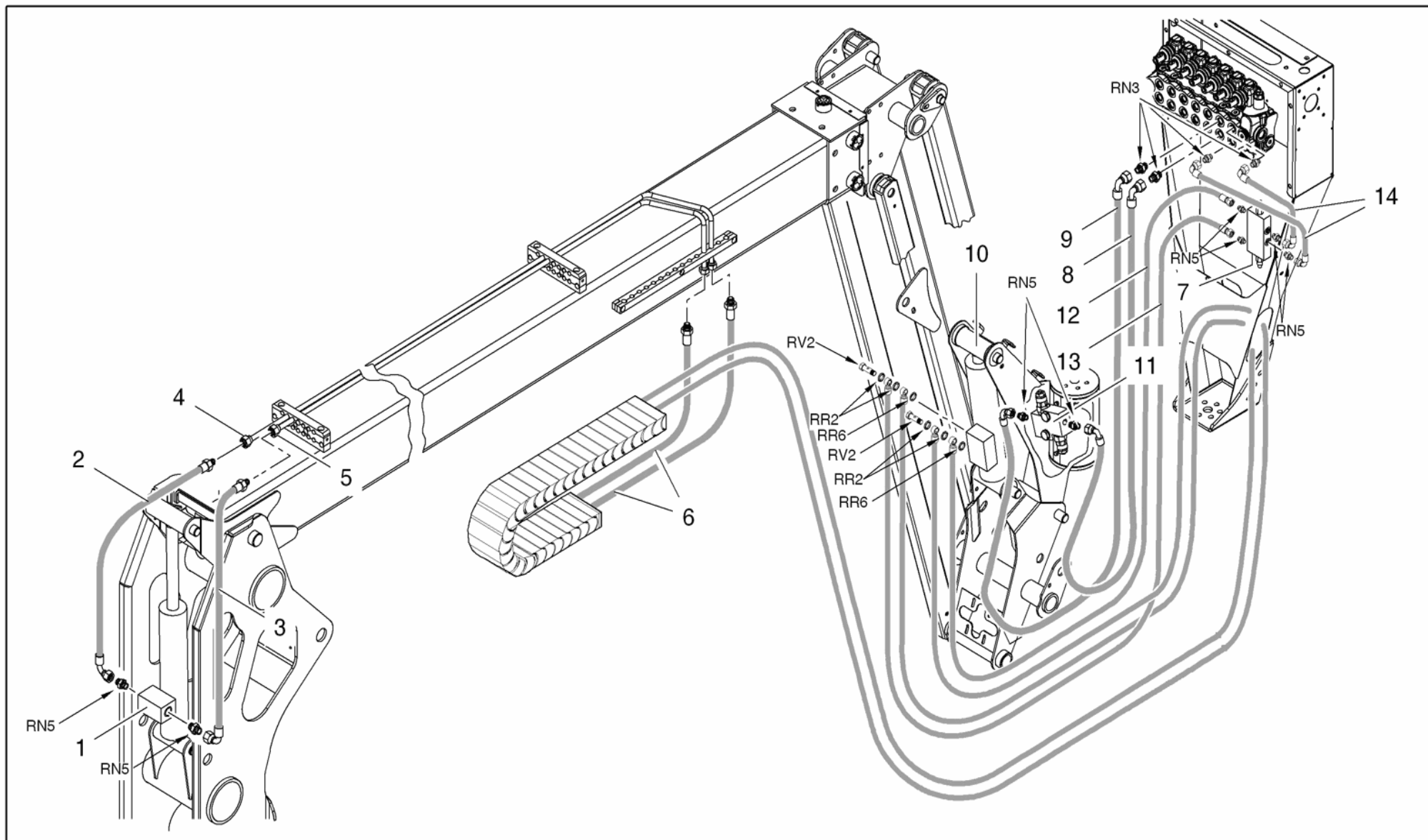





 IMPIANTO IDRAULICO LIVELLAMENTO-ROTAZIONE CESTO

HYDRAULIKANLAGE ZYLINDER ARM-KORBSCHWENKUNG 

 LEVELING CYLINDERS-CAGE ROTATION HYDRAULIC SYSTE

INSTALACIÓN HIDRÁULICA CILINDROS BRAZOS-ROTACIÓN CESTA 

 SYSTÈME HYDRAULIQUE CYLINDRES BRAS-ROTAZIONE PANIER

POS Codice	Q.tà	 Descrizione	 Description	 Designation	 Benennung	 Descripción
1 26269500	1 NR	cilindro	cylinder	vérin	zylinder	cilindro
2 06896600	1 NR	tubo flessibile	flexible pipe	tuyau flexible	schlauch	tubo flexible
3 06896500	1 NR	tubo flessibile	flexible pipe	tuyau flexible	schlauch	tubo flexible
4 06885400	1 NR	tubo rigido	rigid pipe	tuyau rigide	rohr	tubo rígido
5 06885300	1 NR	tubo rigido	rigid pipe	tuyau rigide	rohr	tubo rígido
6 07090000	2 NR	tubo flessibile	flexible pipe	tuyau flexible	schlauch	tubo flexible
7 27089600	1 NR	valvola idraulica	hydraulic valve	valve hydraulique	hydraulikventil	válvula hidráulica
8 06898000	1 NR	tubo flessibile	flexible pipe	tuyau flexible	schlauch	tubo flexible
9 06897600	1 NR	tubo flessibile	flexible pipe	tuyau flexible	schlauch	tubo flexible
10 26269600	1 NR	cilindro	cylinder	vérin	zylinder	cilindro
11 2648910001	1 NR	valvola idraulica	hydraulic valve	valve hydraulique	valve hydraulique	válvula hidráulica
12 07090200	1 NR	tubo flessibile	flexible pipe	tuyau flexible	schlauch	tubo flexible
13 07090100	1 NR	tubo flessibile	flexible pipe	tuyau flexible	schlauch	tubo flexible
14 07090300	2 NR	tubo flessibile	flexible pipe	tuyau flexible	schlauch	tubo flexible

 CILINDRI

ZYLINDER 



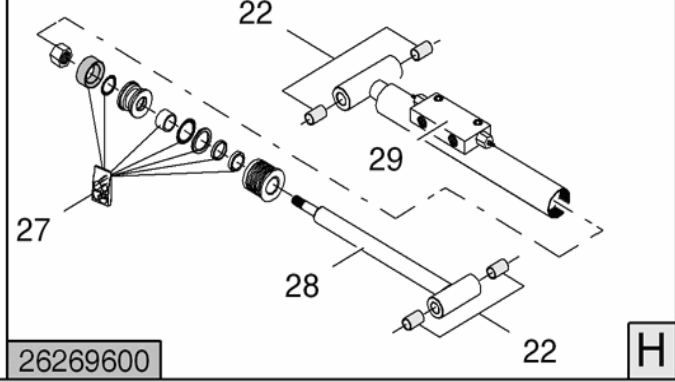
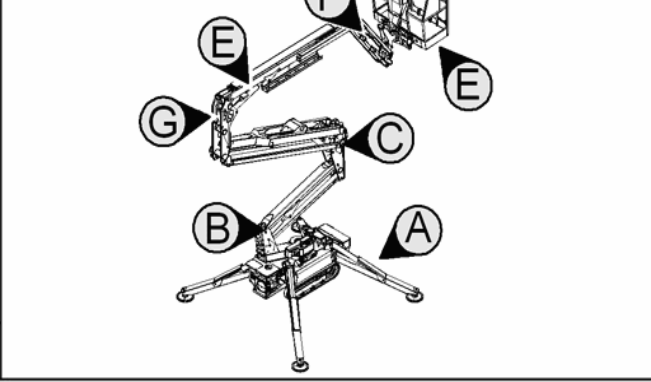
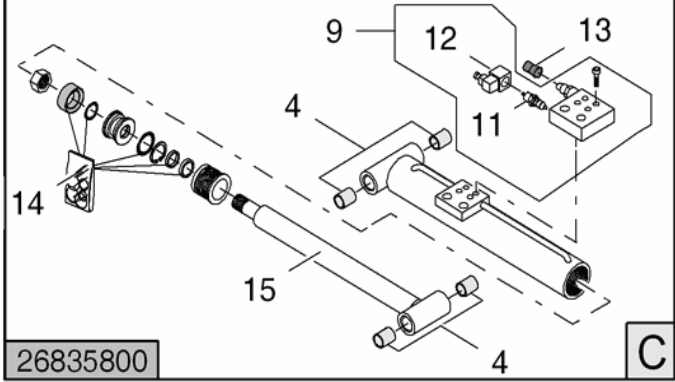
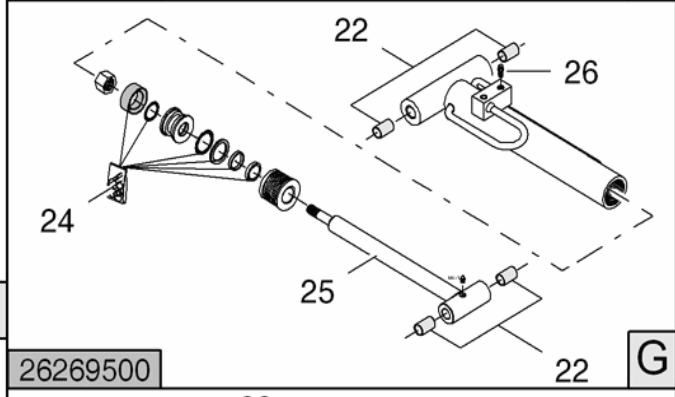
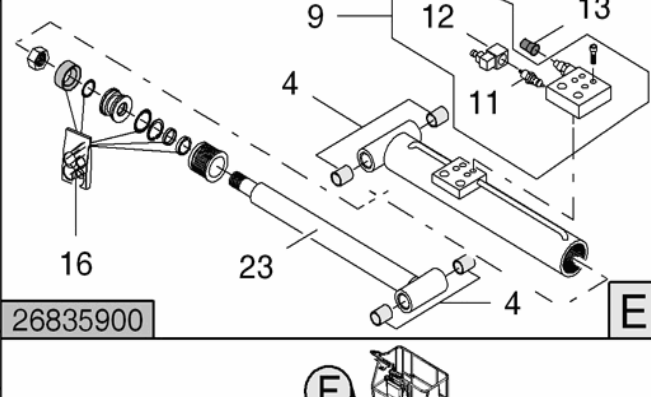
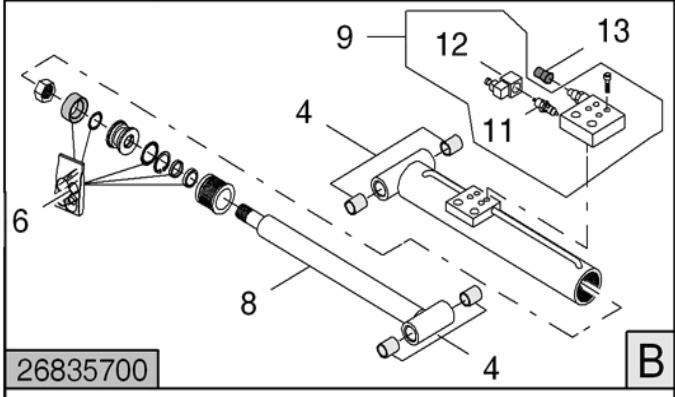
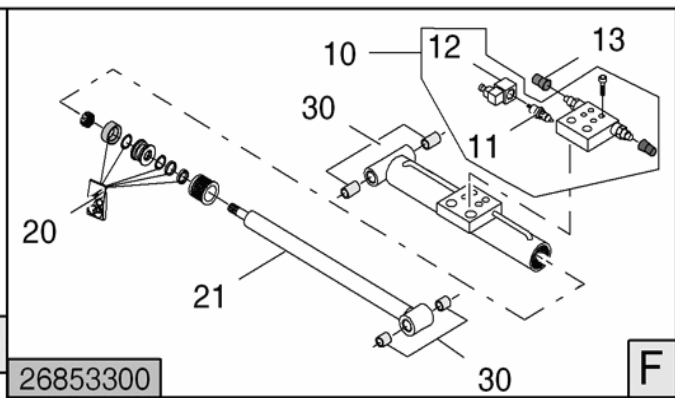
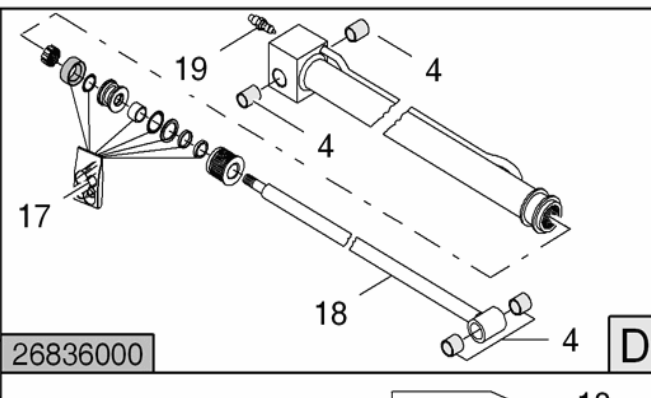
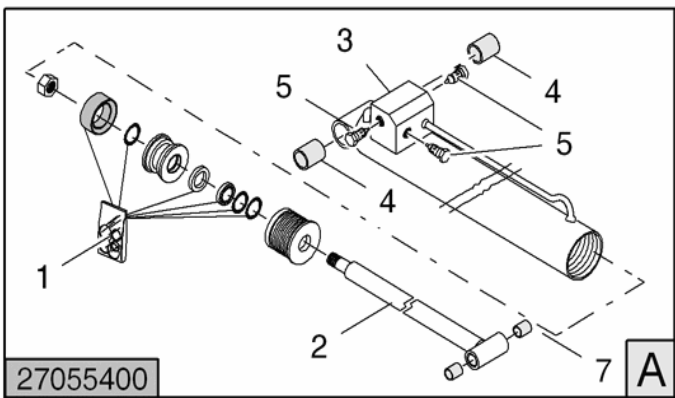

 CYLINDERS

CILINDROS 





 CYLINDRES



 CILINDRIZYLINDER  CYLINDERSCILINDROS  CYLINDRES

POS Codice	Q.tà	 Descrizione	 Description	 Designation	 Benennung	 Descripción
1 2705540001	1 NR	kit guarnizioni	gasket kit	kit joints	dichtungssatz	kit guarniciones
2 2687630002	1 NR	stelo	rod	tige	schaft	vástago
3 2705540002	1 NR	blocchetto	block	bloc	block	bloque
4 2627880005	2 NR	boccola	bush	douille	buchse	casquillo
4 2627880005	1 NR	boccola	bush	douille	buchse	casquillo
5 1541150011	3 NR	valvola idraulica	hydraulic valve	valve hydraulique	valve hydraulique	válvula hidráulica
6 2683570001	1 NR	kit guarnizioni	gasket kit	kit joints	dichtungssatz	kit guarniciones
7 2626900002	2 NR	boccola	bush	douille	buchse	casquillo
8 2683570002	1 NR	stelo	rod	tige	schaft	vástago
9 26137300	1 NR	valvola idraulica	hydraulic valve	valve hydraulique	valve hydraulique	válvula hidráulica
10 26119300	1 NR	valvola idraulica	hydraulic valve	valve hydraulique	valve hydraulique	válvula hidráulica
11 0552550001	1 NR	elettrovalvola	solenoid valve	électrovanne	magnetventil	electroválvula
12 0552550003	1 NR	bobina	coil	bobine	spule	bobina
13 05576200	36 NR	protezione	protection	protection	schutz	protección
14 2683580001	1 NR	kit guarnizioni	gasket kit	kit joints	dichtungssatz	kit guarniciones
15 2683580002	1 NR	stelo	rod	tige	schaft	vástago

 CILINDRIZYLINDER  CYLINDERSCILINDROS  CYLINDRES





POS Codice	Q.tà	 Descrizione	 Description	 Designation	 Benennung	 Descripción
16 2683590001	1 NR	kit guarnizioni	gasket kit	kit joints	dichtungssatz	kit guarniciones
17 2683600001	1 NR	kit guarnizioni	gasket kit	kit joints	dichtungssatz	kit guarniciones
18 2683600002	1 NR	stelo	rod	tige	schaft	vástago
19 05525600	1 NR	valvola idraulica	hydraulic valve	valve hydraulique	valve hydraulique	válvula hidráulica
20 2685330001	1 NR	kit guarnizioni	gasket kit	kit joints	dichtungssatz	kit guarniciones
21 2685330002	1 NR	stelo	rod	tige	schaft	vástago
22 2627890006	4 NR	boccola	bush	douille	buchse	casquillo
23 2683590002	1 NR	stelo	rod	tige	schaft	vástago
24 2626950001	1 NR	kit guarnizioni	gasket kit	kit joints	dichtungssatz	kit guarniciones
25 2626950002	1 NR	stelo	rod	tige	schaft	vástago
26 2588290008	1 NR	vite	screw	vis	schraube	tornillo
27 2626960001	1 NR	kit guarnizioni	gasket kit	kit joints	dichtungssatz	kit guarniciones
28 2626960002	1 NR	stelo	rod	tige	schaft	vástago
29 1553870008	1 NR	valvola idraulica	hydraulic valve	valve hydraulique	valve hydraulique	válvula hidráulica
30 2627910006	4 NR	boccola	bush	douille	buchse	casquillo



 COMPONENTI IMPIANTO ELETTRICO

 KOMponenten ELEKTROANLAGE 
 ELECTRICAL SYSTEM COMPONENTS





 COMPONENTES INSTALACIÓN ELÉCTRICA 
 COMPOSANTS INSTALLATION ÉLECTRIQUE

POS Codice	Q.tà	 Descrizione	 Description	 Designation	 Benennung	 Descripción
1 17048400	1 NR	scatola elettrica	electric box	boîte électrique	elektrogehäuse	caja eléctrica
2 1556350013	1 NR	spina fissa 230v 90°	plug 230v 90 °	cheville	stif	clavija
3 1591270001	1 NR	fotocellula	photocell	cellule photo-électrique	photozelle	fotocélula
4 159127000101	1 NR	cavo elettrico	electric cable	câble électrique	elektrokabel	cable eléctrico
5 1556350001	1 NR	luce stabilizzatore	stabilizer light	lumière stabilisateur	abstützungsbeleuch tung	luz estabilizador
6 1591270011	1 NR	microinterruttore 2 contatti nc testina a pulsante cavo lungo 2 metri	microswitch 2 nc contacts button head long cable 2m	microinterrupteur	mikroschalter	microinterruptor
7 1591270003	1 NR	microinterruttore 2 contatti nc testina rotella acciaio cavo lungo 2 metri	microswitch 2 nc contacts head steel wheel long cable 2m	microinterrupteur	mikroschalter	microinterruptor
8 1591270002	1 NR	catarifrangente	reflector	catadioptré	reflektor	catadióptrico
9 17194800	1 NR	scatola elettrica	electric box	boîte électrique	elektrogehäuse	caja eléctrica
10 27133100	1 NR	scheda elettronica sensore di carico (scatola in alluminio)	electronic board load sensor (aluminum case)	fiche électrique	elektronische platine	placa electrónica

 COMPONENTI IMPIANTO ELETTRICO

 KOMponenten ELEKTROANLAGE 
 ELECTRICAL SYSTEM COMPONENTS

 COMPONENTES INSTALACIÓN ELÉCTRICA 
 COMPOSANTS INSTALLATION ÉLECTRIQUE





POS Codice	Q.tà	 Descrizione	 Description	 Designation	 Benennung	 Descripción
11 07231500	1 NR	scheda elettronica	electronic board	fiche électrique	elektronische platine	placa electrónica
12 1690100001	1 NR	cavo telecomando	remote control cable	câble télécommande	fernbedienungskabel	cable telecomando
13 27174500	1 NR	ricevente radiocomando 868mhz	receiver radio control 868mhz	box contrôle de la radio 868mhz	box fernsteuerung 868mhz	caja control de radio 868mhz
14 1585570005	1 NR	presa elettrica 230v	electrical socket 230v	prise électrique	steckdose	enchufe eléctrico
15 1585570002	1 NR	scatola elettrica	electric box	boîte électrique	elektrogehäuse	caja eléctrica
16 1591270004	1 NR	pulsante	button	bouton	druckknopf	botón
17 25611500	1 NR	cella di carico	load cell	cellule de charge	messdose	célula de carga
18 1556350015	1 NR	interuttore automatico magnetotermico 220v	automatic thermal switch 220v	interrupteur	interruptores	interruptor
19 1690100002	1 NR	scatola elettrica rinvio 140x80x65	electrical box 140x80x65	boite	schachtel	caja
20 1651290010	1 NR	sensore di prossimità	proximity sensor	capteur de proximité	näherungssensor	sensor de proximidad



 COMPONENTI IMPIANTO ELETTRICO

 KOMponenten ELEKTROANLAGE 
 ELECTRICAL SYSTEM COMPONENTS

 COMPONENTES INSTALACIÓN ELÉCTRICA 
 COMPOSANTS INSTALLATION ÉLECTRIQUE

POS Codice	Q.tà	 Descrizione	 Description	 Designation	 Benennung	 Descripción
21 1590900003	1 NR	microinterruttore 2 contatti nc testina braccio disassato e rotella in plastica cavo lungo 2 metri	2 nc contacts microswitch head offset arm and wheel plastic long cable 2m	microinterruteur	mikroschalter	microinterrupor
22 27031700	1 NR	interuttore a pedale	foot switch	interrupteur	interruptores	interruptor
23 17298600	1 NR	cavo 7 poli da scatola rinvio a cesto completo di puntalini	7 pole cable from box reference to a basket	un cable 7 broches	a 7-poliges kabel	a cable 7-pin
24 17289500	1 NR	cavo 7 poli da terra a scatola rinvio completo di puntalini	cable 7 pole from floor to reference box complete	un cable 7 broches	a 7-poliges kabel	a cable 7-pin
25 17473700	1 NR	slitta per connettore 24 vie	slide for 24-way connector	coulisseau	schlitten	corredera
26 17473600	1 NR	parte di connettore 24vie	connector part 24 way	connecteur	verbinger	conectador
27 17306300	18 NR	puntalino femmina per connettore 56 vie scheda master d=1.5	ferrule female connector 56 way main board d = 1.5	butée femelle connecteur 56 voies carte master d = 1.5	auflagestift buchse 56-wege-verbinder masterplatine d = 1.5	conector punta hembra 56 vías tarjeta master d=1,5





 COMPONENTI IMPIANTO ELETTRICO

KOMPONENTEN ELEKTROANLAGE 

 ELECTRICAL SYSTEM COMPONENTS

COMPONENTES INSTALACIÓN ELÉCTRICA 

 COMPOSANTS INSTALLATION ÉLECTRIQUE

POS Codice	Q.tà	 Descrizione	 Description	 Designation	 Benennung	 Descripción
28 17473800	6 NR	puntalino femmina per connettore 24 vie scheda cella di carico d=2.8	ferrule female connector 24 way board load cell d = 2.8	embout femelle pour connecteur 24 voies carte cellule de charge d=2.8	verschraubung buchse für 24-wege-verbinder korblast-platine d=2,8	puntal hembra para conector 24 vías celula de carga d=2.8

 COMPONENTI IMPIANTO ELETTRICO

KOMPONENTEN ELEKTROANLAGE 

 ELECTRICAL SYSTEM COMPONENTS

COMPONENTES INSTALACIÓN ELÉCTRICA 



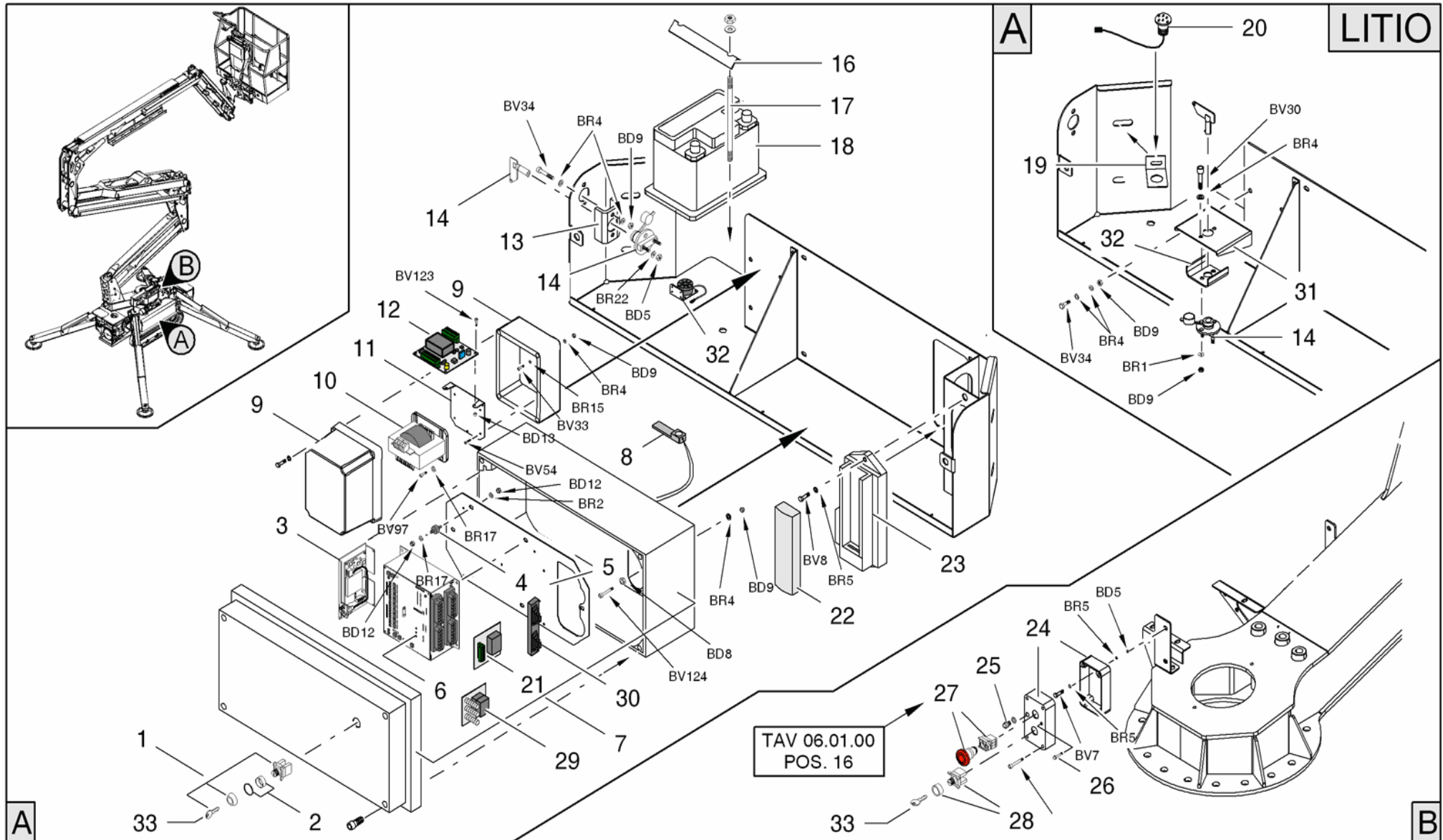

 COMPOSANTS INSTALLATION ÉLECTRIQUE



 COMPONENTI IMPIANTO ELETTRICO

 KOMponenten ELEKTROANLAGE 
 ELECTRICAL SYSTEM COMPONENTS





 COMPONENTES INSTALACIÓN ELÉCTRICA 
 COMPOSANTS INSTALLATION ÉLECTRIQUE

POS Codice	Q.tà	 Descrizione	 Description	 Designation	 Benennung	 Descripción
1 1585570006	1 NR	selettore	selector	sélecteur	wählschalter	selector
2 1602410001	1 NR	adattatore	adapter	adaptateur	adapter	adaptador
3 26608500	1 NR	scheda elettronica	electronic board	fiche électrique	elektronische platine	placa electrónica
4 05971800	1 NR	antivibrante	anti-vibrating	anti - vibrant	vibrationsdämpfer	antivibrante
5 06458600	1 NR	lamiera	plate	tôle	blech	chapa
6 26608200	1 NR	scheda elettronica (+17172600 se fornita a ricambio con software installato)	electronic board (+17172600 if supplied parts with software installed)	fiche électronique	elektronische platine	tarjeta electrónica
6 26907000	1 NR	scheda elettrica versione litio (+17172600 se fornita a ricambio con software installato)	electric board lithium version (+17172600 if supplied parts with software installed)	fiche électrique	elektrische platine	tarjeta eléctrica
7 17049500	1 NR	scatola elettrica	electric box	boîte électrique	elektrogehäuse	caja eléctrica
8 26608600	1 NR	antenna	antenna	antenne	antenne	antena
9 17047500	1 NR	scatola elettrica	electric box	boîte électrique	elektrogehäuse	caja eléctrica
10 1628400004	1 NR	trasformatore 230v	transformer 230v	transformateur 230v	transformator 230v	transformador 230v

 COMPONENTI IMPIANTO ELETTRICO

 KOMponenten ELEKTROANLAGE 
 ELECTRICAL SYSTEM COMPONENTS





 COMPONENTES INSTALACIÓN ELÉCTRICA 
 COMPOSANTS INSTALLATION ÉLECTRIQUE

POS Codice	Q.tà	 Descrizione	 Description	 Designation	 Benennung	 Descripción
11 06543500	1 NR	staffa	bracket	étrier	haltebügel	estribo
12 26608400	1 NR	scheda elettronica	electronic board	fiche électrique	elektronische platine	placa electrónica
13 05568700	1 NR	supporto	support	support	halterung	soporte
14 04774900	1 NR	stacca batteria	battery cut-off device	coupe batterie	batterietrennschalter	corta-batería
16 05561800	1 NR	lamiera	plate	tôle	blech	chapa
17 05535400	2 NR	tirante	tie rod	tirant	turmgestänge	tirante
18 04196900	1 NR	batteria tampone	buffer battery	batterie tampon	pufferbatterie	de amortiguamiento de la batería
18 041969R0	1 NR	batteria secca	dry battery	batterie sans acide	batterie ohne säure	batería sin acido
19 06964500	1 NR	supporto	support	support	halterung	soporte
21 1651290014	1 NR	scheda	board	fiche	platine	placa
22 26877100	2 NR	batteria radio comando	battery	batterie	batteire	batería
23 26877000	1 NR	carica batteria	battery charger	charge batterie	batterielader	carga baterías

 COMPONENTI IMPIANTO ELETTRICO

 KOMponenten ELEKTROANLAGE 
 ELECTRICAL SYSTEM COMPONENTS

 COMPONENTES INSTALACIÓN ELÉCTRICA 
 COMPOSANTS INSTALLATION ÉLECTRIQUE

POS Codice	Q.tà	 Descrizione	 Description	 Designation	 Benennung	 Descripción
24 17044200	1 NR	scatola elettrica versione motore termico	electric box thermic engine version	boîte électrique	elektrogehäuse	caja eléctrica
24 17044700	1 NR	scatola elettrica versione litio	electric box lithium version	boîte électrique	elektrogehäuse	caja eléctrica
25 1628400001	1 NR	pulsante	button	bouton	druckknopf	botón
26 1628400002	1 NR	spia	pilot light	témoin	kontrollleuchte	indicador luminoso
28 1556350007	1 NR	pulsante verde	button	bouton	druckknopf	botón
28 1651290001	1 NR	selettore 3 posizioni per chiave	3 position selector switch for key	sélecteur	wählschalter	selector
29 1690100003	1 NR	scheda elettronica	electronic board	fiche électrique	elektronische platine	placa electrónica
30 17306000	1 NR	parte di connettore	connector part	connecteur	verbinger	conectador
30 17306100	1 NR	coperchio	cover	couvercle	deckel	tapa
30 17306200	1 NR	slitta	slide	coulisseau	schlitten	corredera
30 17306300	1 NR	puntalino femmina per connettore 56 vie scheda master d=1.5	ferrule female connector 56 way main board d = 1.5	butée femelle connecteur 56 voies carte master d = 1.5	auflagestift buchse 56-wege-verbinder masterplatine d = 1.5	conector punta hembra 56 vías tarjeta master d=1,5
31 06922600	1 NR	supporto	support	support	halterung	soporte





 COMPONENTI IMPIANTO ELETTRICO

KOMPONENTEN ELEKTROANLAGE 

 ELECTRICAL SYSTEM COMPONENTS

COMPONENTES INSTALACIÓN ELÉCTRICA 

 COMPOSANTS INSTALLATION ÉLECTRIQUE

POS Codice	Q.tà	 Descrizione	 Description	 Designation	 Benennung	 Descripció
32 06639100	1 NR	avvisatore acustico	acoustic alarm	détecteur acoustique	akustischer melder	sirena
33 1651290015	1 NR	chiave	key	clés	schlüssel	clave
34 17506700	1 NR	kit banco programmazione schede piattaforme	programmation kit	kit programmation	programmationsatz	kit programacion

 COMPONENTI IMPIANTO ELETTRICO LITIO

KOMPONENTEN ELEKTROANLAGE LITHIUM 

 ELECTRICAL SYSTEM COMPONENTS LITHIUM

COMPONENTES INSTALACIÓN ELÉCTRICA LITHIUM 

 COMPOSANTS INSTALLATION ÉLECTRIQUE LITHIUM

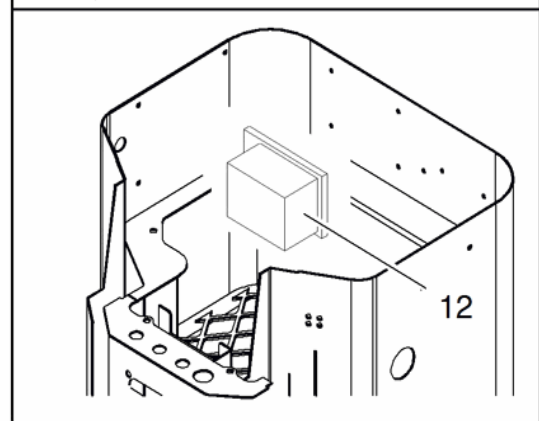
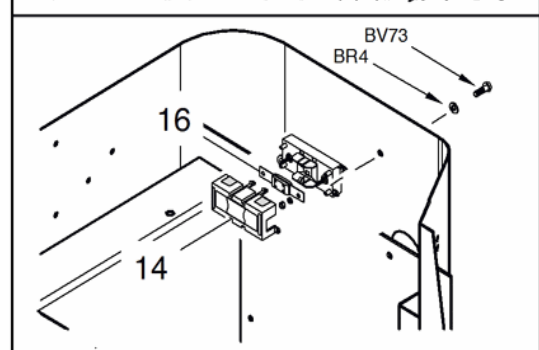
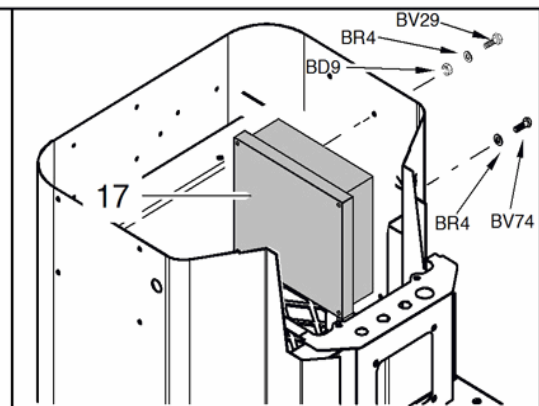
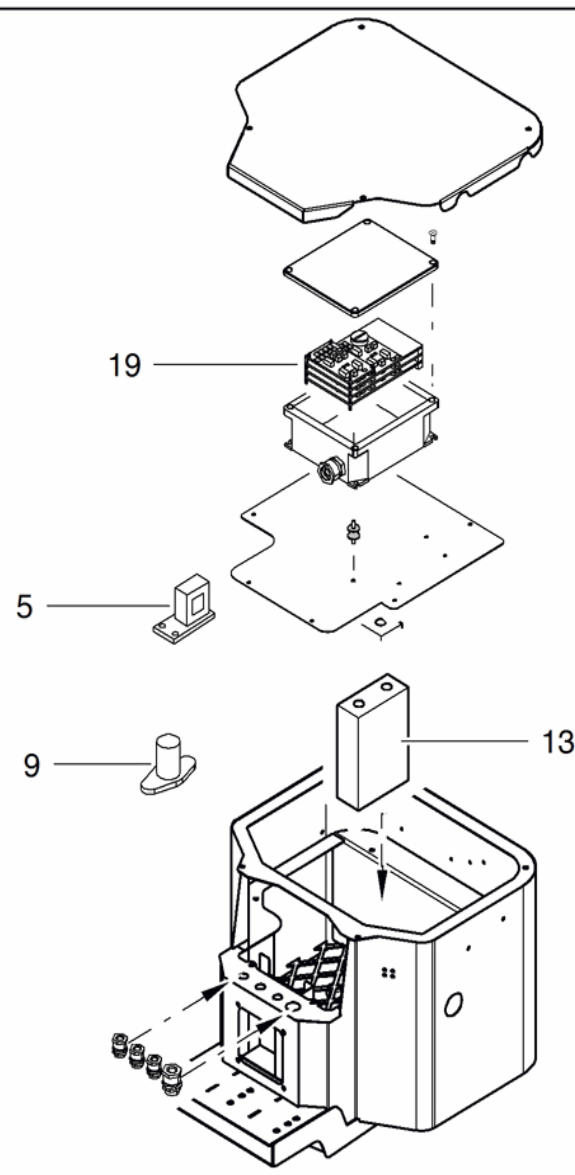
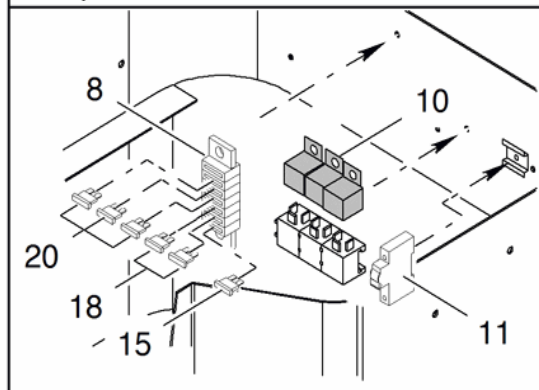
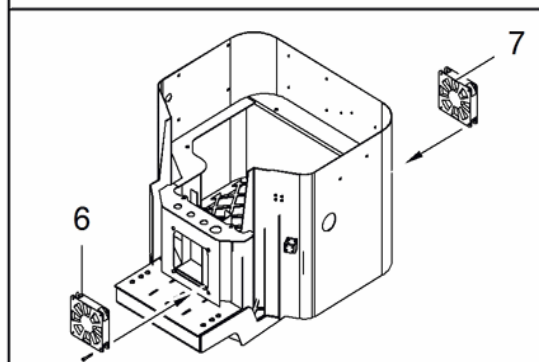
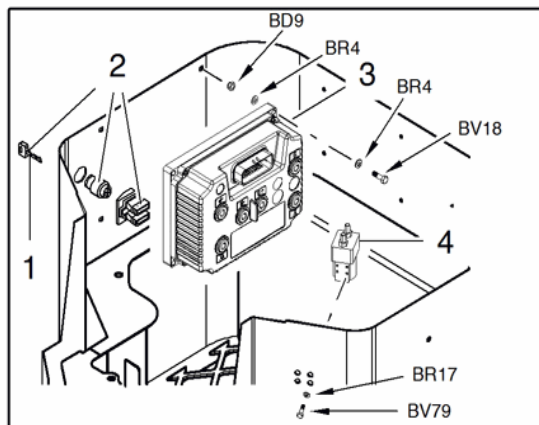







 COMPONENTI IMPIANTO ELETTRICO LITIO

 KOMponenten Elektroanlage Lithium

 ELECTRICAL SYSTEM COMPONENTS LITHIUM

 COMPONENTES INSTALACIÓN ELÉCTRICA LITHIUM

 COMPOSANTS INSTALLATION ÉLECTRIQUE LITHIUM

POS Codice	Q.tà	 Descrizione	 Description	 Designation	 Benennung	 Descripción
1 1692150002	1 NR	chiave accensione	ignition key	clef de démarrage	zündschlüssel	clave de encendido
2 1692150001	1 NR	blocchetto	block	bloc	block	bloque
3 26774600	1 NR	inverter	inverter	inverter	inverter	inverter
4 26429300	1 NR	teleruttore	remote-control switch	télérupteur	fernshalter	teleruptor
5 1735210002	1 NR	trasduttore di corrente (da c170000330)	current transducer (from c170000330)	transformateur d'intensité (da c170000330)	strommessumformer (da c170000330)	transductor de corriente eléctrica (da c170000330)
6 1690690001	1 NR	ventola anteriore	front fan	ventilateur	lüfterrad	ventilador
7 1690690002	1 NR	ventola posteriore	rear fan	ventilateur	lüfterrad	ventilador
8 1690690003	1 NR	blocchetto	fuse holders block	bloc	block	bloque
9 1690690020	1 NR	teleruttore	remote-control switch	télérupteur	fernshalter	teleruptor
10 1690690005	1 NR	relè	relay	relais	relais	relé
11 1690690006	1 NR	temporizzatore	timer	minuteur	timer	temporizador
12 27032500	1 NR	trasformatore	transformer	transformateur	transformator	transformador
13 1690690022	1 NR	cella singola versione a	single cell version a	cellule unique a	einzelzelle a	unicelulares a
13 1742410001	1 NR	cella litio versione b	cell lithium version b	cellule unique b	einzelzelle b	unicelulares b





 COMPONENTI IMPIANTO ELETTRICO LITIO

KOMPONENTEN ELEKTROANLAGE LITHIUM 

 ELECTRICAL SYSTEM COMPONENTS LITHIUM

COMPONENTES INSTALACIÓN ELÉCTRICA LITHIUM 

 COMPOSANTS INSTALLATION ÉLECTRIQUE LITHIUM

POS Codice	Q.tà	 Descrizione	 Description	 Designation	 Benennung	 Descripcìon
14 1690690009	1 NR	coperchio	cover	couvercle	deckel	tapa
15 05760800	1 NR	fusibile 7,5 a	fuse 7,5 a	fusible 7,5 a	sicherungsdraht 7,5 a	fusible 7,5 a
16 1690690011	1 NR	fusibile 160a	fuse 160a	fusible 160a	sicherungsdraht 160a	fusible 160a
17 27193200	1 NR	carica batteria 230v	battery charger 230v	charge batterie 230v	batterielader 230v	carga baterías 230v
18 05760600	1 NR	fusibile 3a	fuse 3a	fusible 3a	sicherungsdraht 3a	fusible 3a
19 1735210001	1 NR	bms 48v nuova versione (da c170000330)	bms 48v new version (from c170000330)	bms 48v	bms 48v	bms 48v
20 05760900	1 NR	fusibile 10a	fuse 10a	fusible 10a	sicherungsdraht 10a	fusible 10a

 TELECOMANDO

FERNSTEUERUNG 

 REMOTE CONTROL

TELECOMANDO 



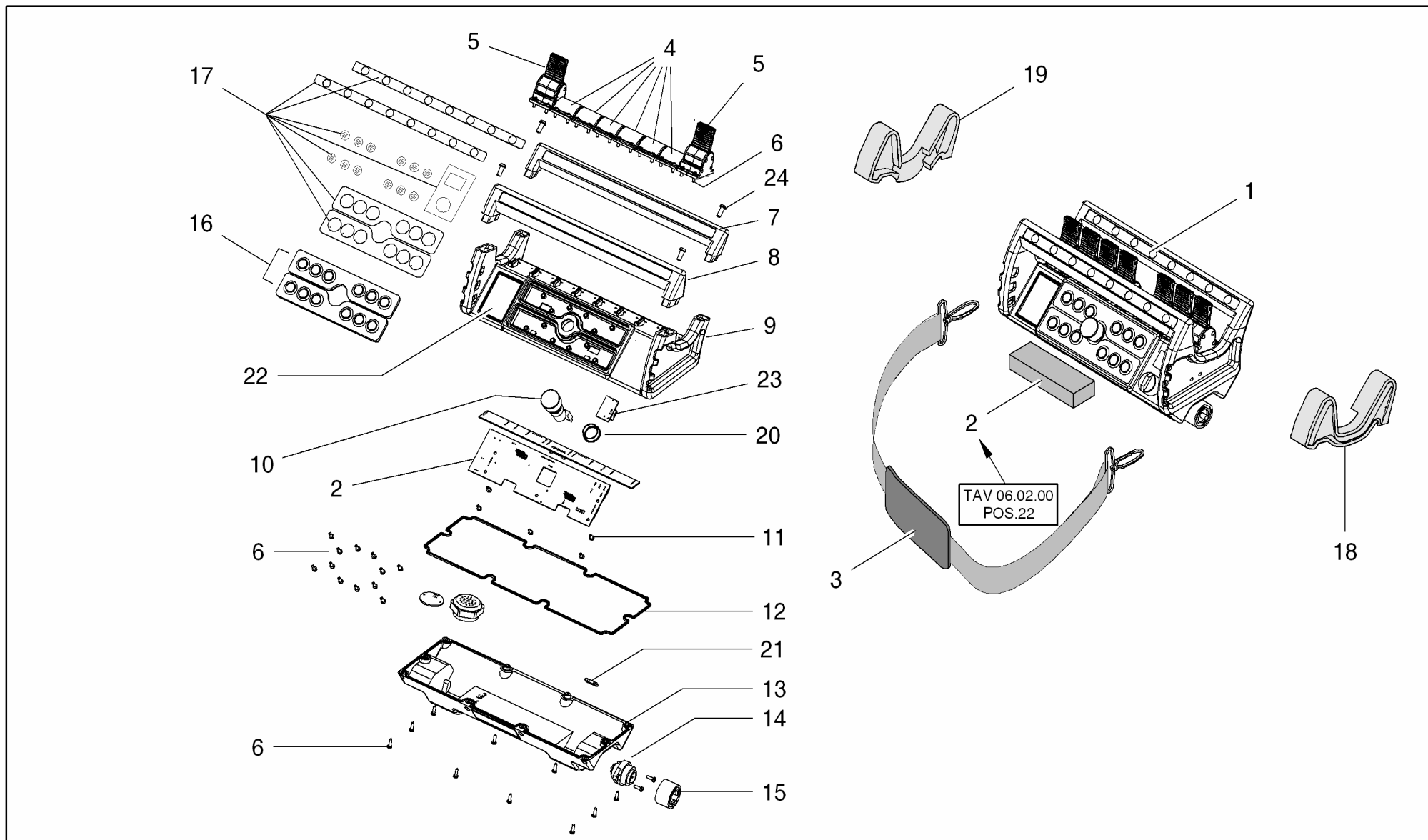

 TÉLÉCOMMANDE



 TELECOMANDO

 FERNSTEUERUNG 
 REMOTE CONTROL





 TELECOMANDO 
 TÉLÉCOMMANDE

POS Codice	Q.tà	 Descrizione	 Description	 Designation	 Benennung	 Descripción
1 27174400	1 NR	radiocomando 868mhz	remote control 868mhz	télécommande 868mhz	fernbedienung 868mhz	mando a distancia 868mhz
2 2717440001	1 NR	scheda elettronica con modulo 868mhz	electronic card with module 868mhz	fiche électrique	elektronische platine	placa electrónica
3 2646170030	1 NR	cinghia	belt	courroie	riemen	correa
4 2646170011	6 NR	coperchio	cover	couvercle	deckel	tapa
5 17550800	1 NR	kit protezione in gomma per joystick rossa	red rubber cover kit for joystick			
5 2646170010	2 NR	leva rossa	lever red	levier	hebel	palanca
6 2646170024	56 NR	vite	screw	vis	schraube	tornillo
7 2646170012	1 NR	impugnatura superiore	grip upper part	poignée	griff	empuñadura
8 2646170013	1 NR	impugnatura inferiore	grip lower part	poignée	griff	empuñadura

 TELECOMANDO

 FERNSTEUERUNG 
 REMOTE CONTROL





 TELECOMANDO 
 TÉLÉCOMMANDE

POS Codice	Q.tà	 Descrizione	 Description	 Designation	 Benennung	 Descripcìon
9 2717440002	1 NR	cover superiore radiocomando+ display e pulsanti (per ricambio serve sn telecomando)	upper huosing with display and buttons (as spare is compulsory the sn of remote control)	couvercle supérieur radiocommande	obere abdeckung funksteuerung	tapa superior radiomando
9 2717440003	1 NR	coperchio superiore radiocomando case blu solo coperchio, senza componenti e senza display	top cover radio control case blue only case, without components and display	couvercle	deckel	tapa
10 2646170008	1 NR	pulsante emergenza	emergency button	bouton d'urgence	notstand knopf	pulsador de emergencia
11 2646170003	5 NR	viti scheda elettronica	attachment screw electronic board	vis	schraube	tornillo
12 2646170022	1 NR	guarnizione	gasket	joint	dichtung	guarnición
13 2687680001	1 NR	coperchio	cover	couvercle	deckel	tapa
14 2646170025	1 NR	connettore	connector	connecteur	verbinger	conectador
15 2646170026	1 NR	coperchio connettore	cover connector	couvercle	deckel	tapa
16 2646170017	2 NR	pulsanti	buttons	boutons	druckknopf	botones
17 17002700	1 NR	kit adesivi	decals kit	kit collants	aufklebersatz	kit pegatinas

 TELECOMANDO

 FERNSTEUERUNG 
 REMOTE CONTROL

 TELECOMANDO 
 TÉLÉCOMMANDE

POS Codice	Q.tà	 Descrizione	 Description	 Designation	 Benennung	 Descripción
18 07027100	1 NR	protezione destra	right protection	protection droits	abdeckung rechts	protección derecha
19 07027200	1 NR	protezione sinistra	left protection	protection gauche	abdeckung links	protección izquierda
20 2646170007	1 NR	anello	ring	bague	ring	anillo
21 07359500	1 NR	contatto reed interno telecomando 3s	reed contact internal remote 3s	reed contact intérieur 3s distance	reedkontakt indoor remote 3s	contacto reed 3s remoto de interior
22 07320200	1 NR	schermo lcd (per ricambio è necessario il sn del telecomando)	display (as spare is compulsory the sn of remote control)	afficher	anzeige	pantalla
23 07359400	1 NR	contatto per stop emergenza telecomando 3s	contact for remote emergency stop 3s	contacter pour remote 3s arret d'urgence	kontakt für remote not 3s	contacto para remotos 3s parada de emergencia
24 2646170014	4 NR	vite	screw	vis	schraube	tornillo

**Cod. 17063700 (no a ricambio/no spare kit)**  
**KIT ADESIVI PIATTAFORMA AEREA /**  
**AERIAL PLATFORM KIT STICKERS**  
**JLG - X17J**

**+ kit in lingua non inclusi nel codice generale e non gestiti a ricambio**  
**+ language code not included in the standard kit and no spare kit**

**170637IT / 170637GB / 170637FR / 170637DE / 170637ES / 170637NL /**  
**170637PT / 170637DA / 170637SW / 170637NO / 170637JA**





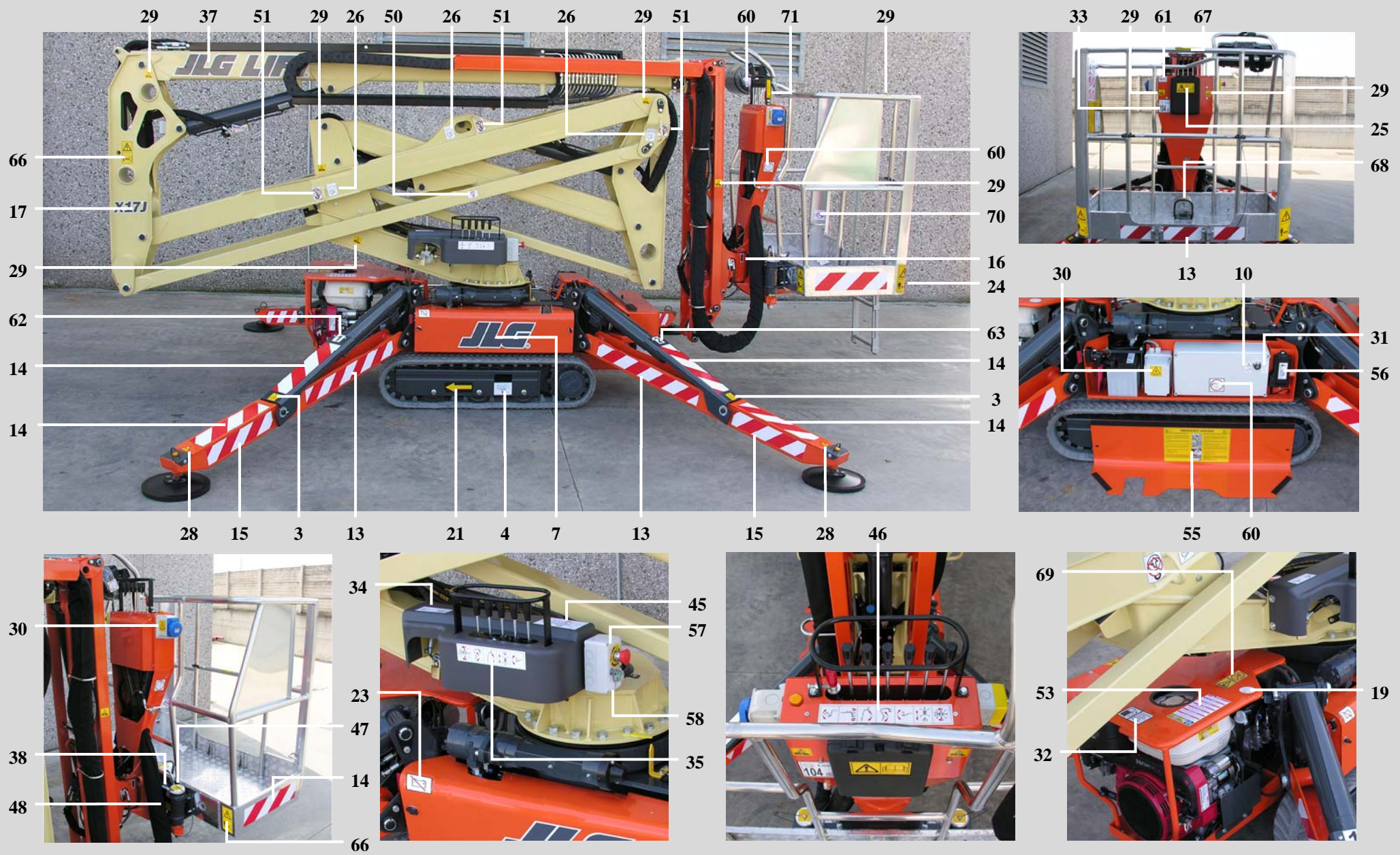

KIT ADESIVI - X17J

SET OF DECALS - X17J

KIT COLLANTS - X17J

AUFKLEBERSATZ - X17J

KIT ADHESIVOS - X17J

ADHESIEKIT - X17J

**Cod. 17063700**

Ed. 13/06/2013

Tav 01



KIT ADESIVI - X17J

SET OF DECALS - X17J

KIT COLLANTS - X17J

AUFKLEBERSATZ - X17J

KIT ADHESIVOS - X17J

ADHESIEKIT - X17J

**Cod. 17063700**

Ed. 13/06/2013

Tav 02

**Cod. 17063700 (no a ricambio/no spare kit)**

**KIT ADESIVI PIATTAFORMA AEREA /  
AERIAL PLATFORM KIT STICKERS  
JLG - X17J**

17063700 POSIZIONE ADESIVI / POSITION STICKERS JLG - X17J Aggiornato il 13/06/2013			IN LINGUA	JLG
			VOLTAGGIO	
POSIZIONE	CODICE	REV.	DESCRIZIONE	QUANTITA'
01				
02	06924300	A	ADESIVO CASCO - IMBRAGATURA - DIVIETI SERIE METAL-IIIS L= 170X250 MM	01
03	1608710003	A	ADESIVO PRESSIONE PIEDINI GL17.80XL L=45X48 GIALLO*	04
04	1608710004	A	ADESIVO PRESSIONE TOTALE AL SUOLO GL17.80XL L=100X69*	02
05	07059600	A	ADESIVO JLG - X17J PORTATA CESTO 2 PERSONE L=135X145 MM	01
06				
07	07060500	A	ADESIVO LOGO JLG L=432x150MM	02
08	1608710001	C	ADESIVO PULSANTI DISTR. A TERRA LATO SX GL17.80 L=194X50 mm	01
09	1608710002	C	ADESIVO PULSANTI DISTRIB A TERRA GL 17.80 LATO SX L= 150X50 mm	01
10	06085900	A	ADESIVO SISTEMA BYPASS PARTE AEREA L=30X50	01
11				
12				
13	06039700	A	ADESIVO CON RIGHE BIANCHE ROSSE L= 700 X 80	09
14	06086700	A	ADESIVO CON RIGHE BIANCHE E ROSSE L=430X100	10
15	06039900	A	ADESIVO CON RIGHE BIANCHE ROSSE L= 420 X 80	08
16	06706500	A	ADESIVO ALLINEAMENTO CESTO (2 PEZZI) L=16X50+13	01
17	07061100	A	ADESIVO JLG LOGO PIATTAFORMA AEREA CINGOLATA X17J L= 200X64,5 MM	02
18	06998800	A	ADESIVO DEVIATORE POMPA MANUALE PIATTAFORMA GL17. 80XL L=86X34	01
19	06060000	A	ADESIVO LIVELLO OLIO MOTORE Ø50mm	01
20				
21	06040500	A	ADESIVO DIREZ. TRASLAZIONE FRECCIA GIALLA SFONDO NERO L=61 X 160	02
22				
23	1702155	A	ADESIVO JLG STACCABATTERIA L= 63,5X50,80 MM	01
24	06040300	A	ADESIVO PERICOLO MANTENERE LE DISTANZE GIALLO L=100 X 200	02
25	06040900	A	ADESIVO LEGGERE IL MANUALE L=125 X 65 GIALLO	02

**17063700 POSIZIONE ADESIVI / POSITION STICKERS**

**JLG - X17J**

**Aggiornato il 13/06/2013**

**IN LINGUA**

**JLG**

**VOLTAGGIO**

POSIZIONE	CODICE	REV.	DESCRIZIONE	QUANTITA'
26	1703814	A	ADESIVO JLG ATTACCO ANCORAGGIO L=55,56X76,2 MM	06
27	1701504	A	ADESIVO JLG OLIO IDRAULICO L=50,8x63,5 MM	01
28	06041200	A	ADESIVO SCHIACCIAMENTO PIEDI TRIANGOLARE L=53X46 GIALLO	04
29	06041300	A	ADESIVO ATTENZIONE PERICOLO TAGLI L=45 X 40 GIALLO	14
30				
31	06086000	A	ADESIVO SISTEMA BYPASS TRASLAZIONE L=30X50	01
32	1701542	A	ADESIVO JLG CARBURANTE BENZINA L= 101X63,5	01
32	1701505	A	ADESIVO JLG CARBURANTE DIESEL L= 50,8X63,5	01
33	07034200	B	ADESIVO RUMORE 104 dB L=90X100	01
34	1608710017	A	ADESIVO DEVIATORE OLIO TERRA / AEREA GL17.80XL IIIS L=100 X 40	01
35	06899100	A	ADESIVO COMANDI A TERRA GL17.80 L= 196X44,5	01
36				
37	07060700	A	ADESIVO LOGO JLG LIFT L=809x130 MM	02
38	1704277	A	ADESIVO JLG ATTACCO CINTURE DI SICUREZZA L= 76,2X19,05 MM	02
39				
40	06044000	A	ADESIVO ATTACCO SOLLEVAMENTO SFONDO BIANCO COLORE BLU Ø40	04
41				
42				
43	06056300	A	ADESIVO PERICOLO SCOTTATURE L=60X51 TRIANGOLARE SFONDO GIALLO	01
44				
45	1608710018	A	ADESIVO PERICOLO NO ROTAZIONE GL17.80XL IIIS L=118 X 80	01
46	1608710006	A	ADESIVO COMANDI SUL CESTO GL 17.80XL IIIS L=266 X 47	01
47				
48				
49				

**17063700 POSIZIONE ADESIVI / POSITION STICKERS****JLG - X17J****Aggiornato il 13/06/2013****IN LINGUA****JLG****VOLTAGGIO**

POSIZIONE	CODICE	REV.	DESCRIZIONE	QUANTITA'
50	07056700	A	ADESIVO JLG DIVIETO DI SOLLEVAMENTO L=54,88X40	02
51	1701499	A	ADESIVO JLG DIVIETO DI SOLLEVAMENTO L= 55,56X76 MM	06
52				
53	06232100	A	ADESIVO "ATTENZIONE BENZINA INFIAMMABILE" 7 LINGUE L= 90X171	01
54	06165000	A	ADESIVO LIVELLO OLIO IDRAULICO Ø50 SFONDO BIANCO	01
55				
56	1608710016	A	ADESIVO MANTENERE 1 METRO DI DISTANZA GL17.80XL IIIS L= 75x35	02
57	1706898	A	ADESIVO JLG EMERGENCY STOP Ø EST.57,15 Ø INT. 30,58	02
58	1608710008	A	ADESIVO AVVIAMENTO MOTORE DA TERRA GL17.80 L=72X40,7	01
59				
60	1001125483	A	ADESIVO JLG VIETATO LAVARE L=63,5X63,5 MM	09
61	1608710015	A	ADESIVO PRESENZA TELECOMANDO GL 17.80XL L=60X40	01
62	06555500	A	ADESIVO NR 1 L=50X60 BIANCO	01
63	06555600	A	ADESIVO NR 2 L=50X60 BIANCO	01
64	06555700	A	ADESIVO N° 3 L=50X60 BIANCO	01
65	06555800	A	ADESIVO N° 4 L=50X60 BIANCO	01
66	07058800	A	ADESIVO PERICOLO MANTENERE LE DISTANZE L=65X130 MM	04
67	1706493	B	ADESIVO JLG SCORRIMENTO SBARRA CHIUSURA CESTO L= 76, 2X25,4 MM	01
68	1705828	B	ADESIVO JLG INTERRUOTORE PEDALE L= 69,85X54	01
69	1706098	B	ADESIVO JLG PERICOLO ESPLOSIONE L=63,5X117,475 MM	01
70	07050700	A	ADESIVO JLG DIVIETO ATTACCO CINTURE DI SICUREZZA L=76, 2X19,5	02
71				
72	07071000	B	ADESIVO JLG CLAXON SU PIATTAFORME L=38,3X28,55 MM	01
05	07059500	A	ADESIVO JLG - X17J PORTATA CESTO 1 PERSONA L=135X145 MM	01

**KIT ADESIVI IN LINGUA /  
LANGUAGEKIT STICKERS**

**JLG - X17J**

**Cod. (no a ricambio/no spare kit)**

**170637IT**

**170637GB**

**170637FR**

**170637DE**

**170637ES**

**170637NL**

**170637PT**

**170637DA**

**170637SW**

**170637NO**

**170637JA**

**170637\*\* ADESIVI IN LINGUA / ADHESIVES IN LANGUAGE**  
**JLG - X17J**  
**Aggiornato il 13/06/2013**

**IN LINGUA**

**JLG**

**VOLTAGGIO**

POSIZIONE	CODICE	REV.	DESCRIZIONE	QUANTITA'
	170637IT		ADESIVI PIATTAFORMA AEREA GL17.80XL LINGUA ITALIANO	
06	06555300	B	ADESIVO USO PIATTAFORMA AEREA CINGOLATA - ITALIANO L= 128X230 01-09-2008	01
30	06561200	A	ADESIVO PERICOLO 230 VOLT GIALLO L=47 X 47	04
47	06448200	A	ADESIVO "SBLOCCARE SOLO NEI CASI PREVISTI" L= 50X50 ITALIANO	02
48	06448100	A	ADESIVO "RIPRISTINARE I TAPPI FERMO GUIDA " ITALIANO L= 90X45	02
55	1608710007	B	ADESIVO ISTRUZIONI DISCESA DI EMERGENZA GL17803S ITALIANO L=290X175*	01
71	07064500	A	ADESIVO SBLOCCARE SOLO COME MANOVRA DI EMERGENZA - ITA L=120X22 MM	01
	170637GB		ADESIVI PIATTAFORMA AEREA GL17.80XL LINGUA INGLESE	
06	06562600	B	ADESIVO USO PIATTAFORMA AEREA CINGOLATA - INGLESE L= 128X230	01
30	06561200	A	ADESIVO PERICOLO 230 VOLT GIALLO L=47 X 47	04
30	06042400	A	ADESIVO PERICOLO 110 VOLT L=47 X 47 GIALLO	04
47	06462700	A	ADESIVO "SBLOCCARE SOLO NEI CASI PREVISTI" INGLESE L= 50X50	02
48	06462100	A	ADESIVO "RIPRISTINARE I TAPPI FERMO GUIDA" INGLESE L= 90X45	02
55	1608710009	B	ADESIVO ISTRUZIONI DISCESA DI EMERGENZA GL17803S INGLESE L=290X175*	01
	170637FR		ADESIVI PIATTAFORMA AEREA GL17.80XL LINGUA FRANCESE	
06	06562700	B	ADESIVO USO PIATTAFORMA AEREA CINGOLATA - FRANCESE L= 128X230	01
30	06561200	A	ADESIVO PERICOLO 230 VOLT GIALLO L=47 X 47	04
47	06462800	A	ADESIVO "SBLOCCARE SOLO NEI CASI PREVISTI" FRANCESE L= 50X50	02
48	06462200	A	ADESIVO "RIPRISTINARE I TAPPI FERMO GUIDA" FRANCESE L= 90X45	02
55	1608710010	B	ADESIVO ISTRUZIONI DISCESA DI EMERGENZA GL17803S FRANCESE L=290X175	01



<b>170637** ADESIVI IN LINGUA / ADHESIVES IN LANGUAGE</b> <b>JLG - X17J</b> <b>Aggiornato il 13/06/2013</b>	<b>IN LINGUA</b>	<b>JLG</b>
	<b>VOLTAGGIO</b>	

POSIZIONE	CODICE	REV.	DESCRIZIONE	QUANTITA'
	170637DE		ADESIVI PIATTAFORMA AEREA GL17.80XL LINGUA TEDESCO	
06	06562800	B	ADESIVO USO PIATTAFORMA AEREA CINGOLATA - TEDESCO L= 128X230	01
30	06561200	A	ADESIVO PERICOLO 230 VOLT GIALLO L=47 X 47	04
47	06462900	A	ADESIVO "SBLOCCARE SOLO NEI CASI PREVISTI " TEDESCO L= 50X50	02
48	06462300	A	ADESIVO "RIPRISTINARE I TAPPI FERMO GUIDA" TEDESCO L= 90X45	02
55	1608710011	B	ADESIVO ISTRUZIONI DISCESA DI EMERGENZA GL17803S TEDESCO L=290X175*	01
	170637ES		ADESIVI PIATTAFORMA AEREA GL17.80XL LINGUA SPAGNOLO	
06	06562900	B	ADESIVO USO PIATTAFORMA AEREA CINGOLATA - SPAGNOLO L=128X230	01
30	06561200	A	ADESIVO PERICOLO 230 VOLT GIALLO L=47 X 47	04
47	06463000	A	ADESIVO "SBLOCCARE SOLO NEI CASI PREVISTI" SPAGNOLO L= 50X50	02
48	06462400	A	ADESIVO "RIPRISTINARE I TAPPI FERMO GUIDA" SPAGNOLO L= 90X45	02
55	1608710012	B	ADESIVO ISTRUZIONI DISCESA DI EMERGENZA GL17803S SPAGNOLO L=290X175	01
	170637NL		ADESIVI PIATTAFORMA AEREA GL17.80XL LINGUA OLANDESE	
06	06563000	B	ADESIVO USO PIATTAFORMA AEREA CINGOLATA - OLANDESE L=128X230	01
30	06561200	A	ADESIVO PERICOLO 230 VOLT GIALLO L=47 X 47	04
47	06463100	A	ADESIVO "SBLOCCARE SOLO NEI CASI PREVISTI" OLANDESE L= 50X50	02
48	06462500	A	ADESIVO "RIPRISTINARE I TAPPI FERMO GUIDE" OLANDESE L= 90X45	02
55	1608710013	C	ADESIVO ISTRUZIONI DISCESA DI EMERGENZA GL17803S OLANDESE L=290X175	01
	170637PT		ADESIVI PIATTAFORMA AEREA GL17.80XL LINGUA PORTOGHESE	
06	06563100	B	ADESIVO USO PIATTAFORMA AEREA CINGOLATA PORTOGHESE L=128X230	01
30	06561200	A	ADESIVO PERICOLO 230 VOLT GIALLO L=47 X 47	04
47	06463200	A	ADESIVO "SBLOCCARE SOLO NEI CASI PREVISTI" PORTOGHESE L= 50X50	02
48	06462600	A	ADESIVO "RIPRISTINARE I TAPPI FERMO GUIDA" PORTOGHESE L= 90X45	02
55	1608710014	B	ADESIVO ISTRUZIONI DISCESA DI EMERGENZA GL17803S PORTOGHESE L=290X175	01

<b>170637** ADESIVI IN LINGUA / ADHESIVES IN LANGUAGE</b> <b>JLG - X17J</b> <b>Aggiornato il 13/06/2013</b>	<b>IN LINGUA</b>	<b>JLG</b>
	<b>VOLTAGGIO</b>	

POSIZIONE	CODICE	REV.	DESCRIZIONE	QUANTITA'
	170637SW		ADESIVI PIATTAFORMA AEREA GL17.80XL LINGUA SVEDESE	
06	07137300	B	ADESIVO USO PIATTAFORMA LINGUA SVEDESE L= 128X230 MM	01
30	06561200	A	ADESIVO PERICOLO 230 VOLT GIALLO L=47 X 47	04
47	07137500	A	ADESIVO "SBLOCCARE SOLO NEI CASI PREVISTI" SVEDESE" L= 50X50 MM	02
48	07137400	A	ADESIVO "RIPRISTINARE I TAPPI FERMO GUIDA" SVEDESE L= 90X45 MM	02
55	1608710020	A	ADESIVO ISTRUZIONI DISCESA DI EMERGENZA GL17803S SVEDESE L=290X175MM	01
	170637DA		ADESIVI PIATTAFORMA AEREA GL17.80XL LINGUA DANESE	
06	07138100	B	ADESIVO USO PIATTAFORMA LINGUA DANESE L= 128X230 MM	01
30	06561200	A	ADESIVO PERICOLO 230 VOLT GIALLO L=47 X 47 MM	04
47	07138000	A	ADESIVO " SBLOCCARE SOLO NEI CASI PREVIST I " DANESE L= 50X50 MM	02
48	07137900	A	ADESIVO "RIPRISTINARE I TAPPI FERMO GUIDA" DANESE L= 90X45 MM	02
55	1608710023	A	ADESIVO ISTRUZIONI DISCESA DI EMERG. GL17803S DANESE GIALLO L=290X175 MM	01
	170637NO		ADESIVI PIATTAFORMA AEREA GL17.80XL LINGUA NORVEGESE	
06	07162000	B	ADESIVO USO PIATTAFORMA LINGUA NORVEGESE L= 128X230 MM	01
30	06561200	A	ADESIVO PERICOLO 230 VOLT GIALLO L=47 X 47 MM	04
47	07161800	A	ADESIVO " SBLOCCARE SOLO NEI CASI PREVIST I " NORVEGESE L= 50X50 MM	02
48	07161900	A	ADESIVO "RIPRISTINARE I TAPPI FERMO GUIDA" NORVEGESE L= 90X45 MM	02
55	1608710024	A	ADESIVO ISTRUZ. DISCESA DI EMERG.GL17803S NORVEGESE GIALLO L=290X175 MM	01

**Cod. 17187700 (no a ricambio/no spare kit)**

**KIT INTEGRAZIONE ADESIVI PER PIATTAFORME AEREE LITHIUM-CE /  
INTEGRATION KIT STICKERS PLATFORMS LITHIUM-CE**

**X14J - X14J-H - X17J - X17JPLUS - X19J - X20JPLUS - X23J**

*Da usare in aggiunta a / To use in added to*

**X14J - cod.17063500 / X14J-H - cod.17065000 / X17J cod.17063700 / X17JPLUS cod. 17242800 /  
X19J cod.17063200 / X20JPLUS cod. 17351800 / X23J cod.17062700**

**+ kit in lingua non inclusi nel codice generale e non gestiti a ricambio**

**+ *language code not included in the standard kit and no spare kit***

**+171877IT + 171877GB + 171877FR + 171877DE + 171877ES + 171877NL**

**+ 171877PT + 171877SW + 171877DA + 171877NO + 171877JA**





9



16



4



5



KIT ADESIVI - X14J

SET OF DECALS - X14J

KIT COLLANTS - X14J

AUFKLEBERSATZ - X14J

KIT ADHESIVOS - X14J

ADHESIEKIT - X14J

**cod. 17187700**

Ed. 02/05/2013

Tav 01

9



1



4  
17

4



13



KIT ADESIVI - X14J

SET OF DECALS - X14J

KIT COLLANTS - X14J

AUFKLEBERSATZ - X14J

KIT ADHESIVOS - X14J

ADHESIEKIT - X14J

**cod. 17187700**

Ed. 02/05/2013

Tav 02



9



16



4



5



KIT ADESIVI - X17J

SET OF DECALS - X17J

KIT COLLANTS - X17J

AUFKLEBERSATZ - X17J

KIT ADHESIVOS - X17J

ADHESIEKIT - X17J

**cod. 17187700**

**Ed. 02/05/2013**

**Tav 01**



13

1



4

17

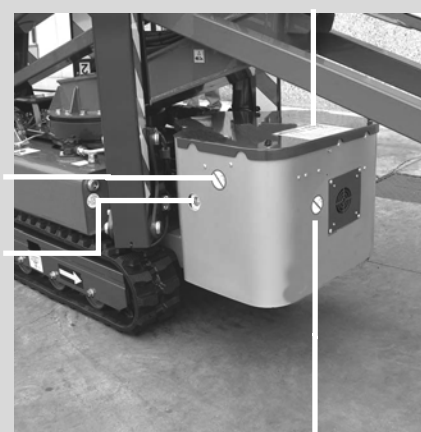

4



KIT ADESIVI - X17J

SET OF DECALS - X17J

KIT COLLANTS - X17J

AUFKLEBERSATZ - X17J

KIT ADHESIVOS - X17J

ADHESIEKIT - X17J

**cod. 17187700**

Ed. 02/05/2013

Tav 02





9



16



1

4

4

5



KIT ADESIVI - X17JPLUS

SET OF DECALS - X17JPLUS

KIT COLLANTS - X17JPLUS

AUFKLEBERSATZ - X17JPLUS

KIT ADHESIVOS - X17JPLUS

ADHESIEKIT - X17JPLUS

**cod. 17187700**

Ed. 02/05/2013

Tav 01



9



13



4

17



3



KIT ADESIVI - X17JPLUS

SET OF DECALS - X17JPLUS

KIT COLLANTS - X17JPLUS

AUFKLEBERSATZ - X17JPLUS

KIT ADHESIVOS - X17JPLUS

ADHESIEKIT - X17JPLUS

**cod. 17187700**

**Ed. 02/05/2013**

**Tav 02**



16



9

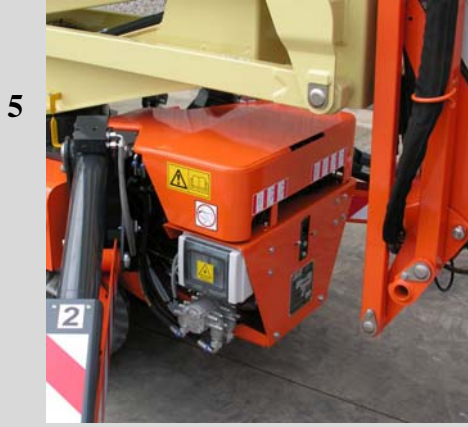

KIT ADESIVI - X19J

SET OF DECALS - X19J

KIT COLLANTS - X19J

AUFKLEBERSATZ - X19J

KIT ADHESIVOS - X19J

ADHESIEKIT - X19J

**cod. 17187700**

Ed. 02/05/2013

Tav 01



9

4

17



13



KIT ADESIVI - X19J

SET OF DECALS - X19J

KIT COLLANTS - X19J

AUFKLEBERSATZ - X19J

KIT ADHESIVOS - X19J

ADHESIEKIT - X19J

**cod. 17187700**

Ed. 02/05/2013

Tav 02



9

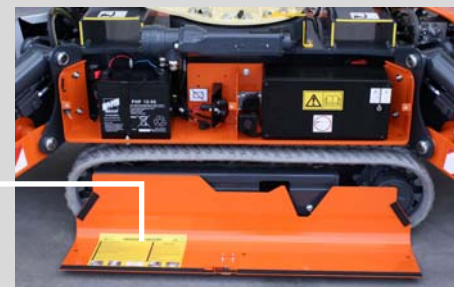

16



1

4

4



5



KIT ADESIVI - X20JPLUS

SET OF DECALS - X20JPLUS

KIT COLLANTS - X20JPLUS

AUFKLEBERSATZ - X20JPLUS

KIT ADHESIVOS - X20JPLUS

ADHESIEKIT - X20JPLUS

**cod. 17187700**

Ed. 02/05/2013

Tav 01



9



13



4

17



3



KIT ADESIVI - X20JPLUS

SET OF DECALS - X20JPLUS

KIT COLLANTS - X20JPLUS

AUFKLEBERSATZ - X20JPLUS

KIT ADHESIVOS - X20JPLUS

ADHESIEKIT - X20JPLUS

**cod. 17187700**

**Ed. 02/05/2013**

**Tav 02**



KIT ADESIVI - X23J

SET OF DECALS - X23J

KIT COLLANTS - X23J

AUFKLEBERSATZ - X23J

KIT ADHESIVOS - X23J

ADHESIEKIT - X23J

**cod. 17187700**

**Ed. 02/05/2013**

**Tav 01**

Sotto il carter / Under the hood

18

4



18



1

16



4



9



KIT ADESIVI - X23J

SET OF DECALS - X23J

KIT COLLANTS - X23J

AUFKLEBERSATZ - X23J

KIT ADHESIVOS - X23J

ADHESIEKIT - X23J

**cod. 17187700**

Ed. 02/05/2013

Tav 02



**Cod. 17187700** (*no a ricambio/no spare kit*)

**KIT INTEGRAZIONE ADESIVI PER PIATTAFORME AEREE LITHIUM-CE**  
***INTEGRATION KIT STICKERS PLATFORMS LITHIUM-CE***  
**X14J - X14J-H - X17J - X17JPLUS - X19J - X23J**

**17187700 POSIZIONE ADESIVI 7 LINGUE /  
POSITION LANGUAGE STICKERS**  
Aggiornato il / Updated 02/05/2013

**IN LINGUA / LANGUAGE**

**JLG**

**VOLTAGGIO / VOLTAGE**

POS.	COD.	REV.	DESCRIZIONE / DESCRIPTION	Q.tà
	17187700		KIT INTEGRAZIONE ADESIVI PER PIATTAFORME AEREE CE LITHIUM X14J - X14J-H - X17J - -X19J -	
01				
02				
03				
04	1001125483	A	ADESIVO JLG VIETATO LAVARE L=63,5X63,5 MM	03
05	06506400	B	ADESIVO " CHIAVE DI ACCENSIONE" ESTERNO Ø 49 FORO Ø 22 SERIE LITHIUM ION	01
06				
07				
08				02
09	06520600	B	ADESIVO RUMORE 88 dB L=90x100	02
10				
11				
12				
13				
14				
15				
16				
17	07264700	A	ADESIVO INDICATORE LED CARICABATTERIE 48V (Ø EST.31MM Ø INT.6 MM) VECCHIO BMS (FINO A C170000329)	01
	07394800	A	ADESIVO INDICATORE LED CARICABATTERIE 48V (Ø EST.31MM Ø INT.6 MM) NUOVO BMS/4 (DA C170000330)	01
18	07264800	A	ADESIVO INDICATORE LED RICARICA BATTERIE Ø EST.21MM Ø INT.4 MM	02

**KIT ADESIVI IN LINGUA PER /  
LANGUAGE KIT STICKERS FOR  
X14J - X14J-H - X17J - X17JPLUS - X19J - X20JPLUS - X23J**

***Cod. (no a ricambio/no spare kit)***

**- 171877IT + 171877GB + 171877FR + 171877DE + 171877ES  
+ 171877NL + 171877PT + 171877SW + 171877DA + 171877NO  
+ 171877JA**

**171877\*\* POSIZIONE ADESIVI IN LINGUA /  
POSITION LANGUAGE STICKERS**  
Aggiornato il / Updated 02/05/2013

**IN LINGUA / LANGUAGE**

**JLG**

**VOLTAGGIO / VOLTAGE**

POS.	COD.	REV.	DESCRIZIONE / DESCRIPTION	Q.tà
	171877IT		KIT ADESIVI INTEGR. PIATT. AEREA X14J-H- X14J - X17J - X19J X23J LITHIUM - LINGUA ITALIANO	
01	07188700	A	ADESIVO JLG ATTENZIONE PERICOLO BATTERIE - ITA L=210X145 MM	01
07				
10				
11				
12				
13	07188100	A	ADESIVO JLG RICARICARE LE BATTERIE DOPO L'USO O ALMENO OGNI 3 MESI L=50x50 MM – ITA	01
14				
16 solo X14J-H	1693870003	B	ADESIVO ISTRUZIONI DISCESA EMERGENZA GL1470LI ITALIANO GIALLO L=290x175 MM (**)	01
16 solo X17J	1705720001	A	ADESIVO ISTRUZIONI DISCESA DI EMERGENZA GL14703S LITHIUM ITALIANO L=290X175 MM (**)	01
16			<b>Per le / for X14J - X17JPLUS - X19J - X20JPLUS - X23J Vedere discesa di emergenza motore termico / See emergency lowering heat engine</b>	
	171877GB		KIT ADESIVI INTEGR. PIATT. AEREA X14J-H- X14J - X17J - X19J X23J LITHIUM - LINGUA INGLESE	
01	07201700	A	ADESIVO JLG ATTENZIONE PERICOLO BATTERIE - ING L=210X145 MM	01
07				
10				
11				
12				
13	07202100	A	ADESIVO JLG RICARICARE LE BATTERIE DOPO L'USO O ALMENO OGNI 3 MESI L=50x50 MM -ING	01
14				
16 per X14J-H	1693870004	B	ADESIVO ISTRUZIONI DISCESA EMERGENZA GL1470LI INGLESE GIALLO L=290x175 MM	01
16 per X17J	1705720002	A	ADESIVO ISTRUZIONI DISCESA DI EMERGENZA GL14703S LITHIUM INGLESE L=290X175 MM	01
16			<b>Per le / for X14J - X17JPLUS - X19J - X20JPLUS - X23J Vedere discesa di emergenza motore termico / See emergency lowering heat engine</b>	

**171877\*\* POSIZIONE ADESIVI IN LINGUA /  
POSITION LANGUAGE STICKERS**  
Aggiornato il / Updated 02/05/2013

**IN LINGUA / LANGUAGE**

**JLG**

**VOLTAGGIO / VOLTAGE**

POS.	COD.	REV.	DESCRIZIONE / DESCRIPTION	Q.tà
	171877FR		KIT ADESIVI INTEGR. PIATT. AEREA X14J-H- X14J - X17J - X19J X23J LITHIUM - LINGUA FRANCESE	
01	07201800	A	ADESIVO JLG ADESIVO ATTENZIONE PERICOLO BATTERIE - FRA L=210X145 MM	01
07				
10				
11				
12				
13	07202200	A	ADESIVO JLG RICARICARE LE BATTERIE DOPO L'USO ALMENO OGNI 3 MESI - FRA L=50x50 MM	01
14				
16 per X14J-H	1693870005	B	ADESIVO ISTRUZIONI DISCESA EMERGENZA GL1470LI FRANCESE GIALLO L=290x175 MM (**)	01
16 per X17J	1705720003	A	ADESIVO ISTRUZIONI DISCESA DI EMERGENZA GL14703S LITHIUM FRANCESE L=290X175 MM (**)	01
16	/	/	<b>Per le / for X14J - X17JPLUS - X19J - X20JPLUS - X23J Vedere discesa di emergenza motore termico / See emergency lowering heat engine</b>	01
	171877DE		KIT ADESIVI INTEGR. PIATT. AEREA X14J-H- X14J - X17J - X19J X23J LITHIUM - LINGUA TEDESCO	
01	07188800	A	ADESIVO JLG ATTENZIONE PERICOLO BATTERIE - TED L=210X145 MM	01
07				
10				
11				
12				
13	07188200	A	ADESIVO JLG RICARICARE LE BATTERIE DOPO L'USO O ALMENO OGNI 3 MESI L=50x50 MM –TED	01
14				
16 per X14J-H	1693870006	B	ADESIVO ISTRUZIONI DISCESA EMERGENZA GL1470LI TEDESCO GIALLO L=290x175 MM (**)	01
16 per X17J	1705720004	A	ADESIVO ISTRUZIONI DISCESA DI EMERGENZA GL14703S LITHIUM TEDESCO L=290X175 MM (**)	01
16	/	/	<b>Per le / for X14J - X17JPLUS - X19J - X20JPLUS - X23J Vedere discesa di emergenza motore termico / See emergency lowering heat engine</b>	01

**171877\*\* POSIZIONE ADESIVI IN LINGUA /  
POSITION LANGUAGE STICKERS**  
Aggiornato il / Updated 02/05/2013

**IN LINGUA / LANGUAGE**

**JLG**

**VOLTAGGIO / VOLTAGE**

POS.	COD.	REV.	DESCRIZIONE / DESCRIPTION	Q.tà
	171877ES		KIT ADESIVI INTEGR. PIATT. AEREA X14J-H- X14J - X17J - X19J X23J LITHIUM - LINGUA SPAGNOLO	
01	07201900	A	ADESIVO JLG ATTENZIONE PERICOLO BATTERIE - SPA L=210X145 MM -	01
07				
10				
11				
12				
13	07202300	A	ADESIVO JLG RICARICARE LE BATTERIE DOPO L'USO ALMENO OGNI 3 MESI - SPA L=50x50 MM	01
14				
16 per X14J-H	1693870007	B	ADESIVO ISTRUZIONI DISCESA EMERGENZA GL1470LI SPAGNOLO GIALLO L=290x175 (**)	01
16 per X17J	1705720005	A	ADESIVO ISTRUZIONI DISCESA DI EMERGENZA GL14703S LITHIUM SPAGNOLO L=290X175 MM (**)	01
16			<b>Per le / for X14J - X17JPLUS - X19J - X20JPLUS - X23J Vedere discesa di emergenza motore termico / See emergency lowering heat engine</b>	
	171877NL		KIT ADESIVI INTEGR. PIATT. AEREA X14J-H- X14J - X17J - X19J X23J LITHIUM - LINGUA OLANDESE	
01	07188900	A	ADESIVO JLG ATTENZIONE PERICOLO BATTERIE - OLA L=210X145 MM	01
07				
10				
11				
12				
13	07188300	A	ADESIVO JLG RICARICARE LE BATTERIE DOPO L'USO O ALMENO OGNI 3 MESI L=50x50 MM – OLA	01
14				
16 per X14J-H	1693870008	B	ADESIVO ISTRUZIONI DISCESA EMERGENZA GL1470LI OLANDESE GIALLO L=290x175 MM (**)	01
16 per X17J	1705720006	A	ADESIVO ISTRUZIONI DISCESA DI EMERGENZA GL14703S LITHIUM OLANDESE L=290X175 MM (**)	01
16			<b>Per le / for X14J - X17JPLUS - X19J - X20JPLUS - X23J Vedere discesa di emergenza motore termico / See emergency lowering heat engine</b>	01

**171877\*\* POSIZIONE ADESIVI IN LINGUA /  
POSITION LANGUAGE STICKERS**  
Aggiornato il / Updated 02/05/2013

**IN LINGUA / LANGUAGE**

**JLG**

**VOLTAGGIO / VOLTAGE**

POS.	COD.	REV.	DESCRIZIONE / DESCRIPTION	Q.tà
	171877PT		KIT ADESIVI INTEGR. PIATT. AEREA X14J-H-X14J-X17J-X19J-X23J LITHIUM - LINGUA PORTOGHESE	
01	07202000	A	ADESIVO JLG ATTENZIONE PERICOLO BATTERIE - POR L=210X145 MM	01
07				
10				
11				
12				
13	07202400	A	ADESIVO JLG RICARICARE LE BATTERIE DOPO L'USO O ALMENO OGNI 3 MESI L=50x50 MM – POR	01
14				
16 per X14J-H	1693870009	B	ADESIVO ISTRUZIONI DISCESA EMERGENZA GL1470LI PORTOGHESE GIALLO L=290x175 MM (**)	01
16 per X17J	1705720007	A	ADESIVO ISTRUZ. DISCESA DI EMERGENZA GL14703S LITHIUM PORTOGHESE L=290X175 MM (**)	01
16			<b>Per le / for X14J - X17JPLUS - X19J - X20JPLUS - X23J Vedere discesa di emergenza motore termico / See emergency lowering heat engine</b>	
	171877SW		KIT ADESIVI INTEGR. PIATT. AEREA X14J-H-X14J-X17J-X19J-X23J LITHIUM - SVEDESE	
01	07189000	A	ADESIVO JLG ATTENZIONE PERICOLO BATTERIE - SVE L=210X145 MM	01
07				
10				
11				
12				
13	07188400	A	ADESIVO JLG RICARICARE LE BATTERIE DOPO L'USO O ALMENO OGNI 3 MESI L=50x50 MM – SVE	01
14				
16 per X14J-H	1693870010	A	ADESIVO ISTRUZIONI DISCESA EMERGENZA GL1470LI SVEDESE GIALLO L=290x175 MM (**)	01
16 per X17J	1705720010	A	ADESIVO ISTRUZ. DISCESA DI EMERGENZA GL14703S LITHIUM SVEDESE L=290X175 MM (**)	01
16			<b>Per le / for X14J - X17JPLUS - X19J - X20JPLUS - X23J Vedere discesa di emergenza motore termico / See emergency lowering heat engine</b>	

**171877\*\* POSIZIONE ADESIVI IN LINGUA /  
POSITION LANGUAGE STICKERS**  
Aggiornato il / Updated 02/05/2013

**IN LINGUA / LANGUAGE**

**JLG**

**VOLTAGGIO / VOLTAGE**

POS.	COD.	REV.	DESCRIZIONE / DESCRIPTION	Q.tà
	171877DA		KIT ADESIVI INTEGR. PIATT. AEREA X14J-H-X14J-X17J-X19J-X23J LITHIUM - LINGUA DANESE	
01	07189100	A	ADESIVO JLG ATTENZIONE PERICOLO BATTERIE - DAN L=210X145 MM	01
07				
10				
11				
12				
13	07188500	A	ADESIVO JLG RICARICARE LE BATTERIE DOPO L'USO O ALMENO OGNI 3 MESI L=50x50 MM – DAN	01
14				
16 per X14J-H	1693870011	A	ADESIVO ISTRUZIONI DISCESA EMERGENZA GL1470LI SVEDESE DANESE L=290x175 MM (**)	01
16 per X17J	1705720011	A	ADESIVO ISTRUZ. DISCESA DI EMERGENZA GL14703S LITHIUM DANESE L=290X175 MM (**)	01
16			<b>Per le / for X14J - X17JPLUS - X19J - X20JPLUS - X23J Vedere discesa di emergenza motore termico / See emergency lowering heat engine</b>	
	171877NO		KIT ADESIVI INTEGR. PIATT. AEREA X14J-H-X14J-X17J-X19J-X23J LITHIUM - LINGUA NORVEGESE	
01	07189200	A	ADESIVO JLG ATTENZIONE PERICOLO BATTERIE - NOR L=210X145 MM	01
07				
10				
11				
12				
13	07188600	A	ADESIVO JLG RICARICARE LE BATTERIE DOPO L'USO O ALMENO OGNI 3 MESI L=50x50 MM – NOR	01
14				
16 per X14J-H	1693870012	A	ADESIVO ISTRUZIONI DISCESA EMERGENZA GL1470LI NORVEGESE GIALLO L=290x175 MM (**)	01
16 per X17J	1705720012	A	ADESIVO ISTRUZ. DISCESA DI EMERGENZA GL14703S LITHIUM NORVEGESE L=290X175 MM (**)	01
16	/	/	<b>Per le / for X14J - X17JPLUS - X19J - X20JPLUS - X23J Vedere discesa di emergenza motore termico / See emergency lowering heat engine</b>	





# TABELLA PERNI/SPINE (PINS TABLE)

LOCKING SYSTEM  
GHIERA  
(LOCKNUTS CODE)  
REF. TABLE BELOW

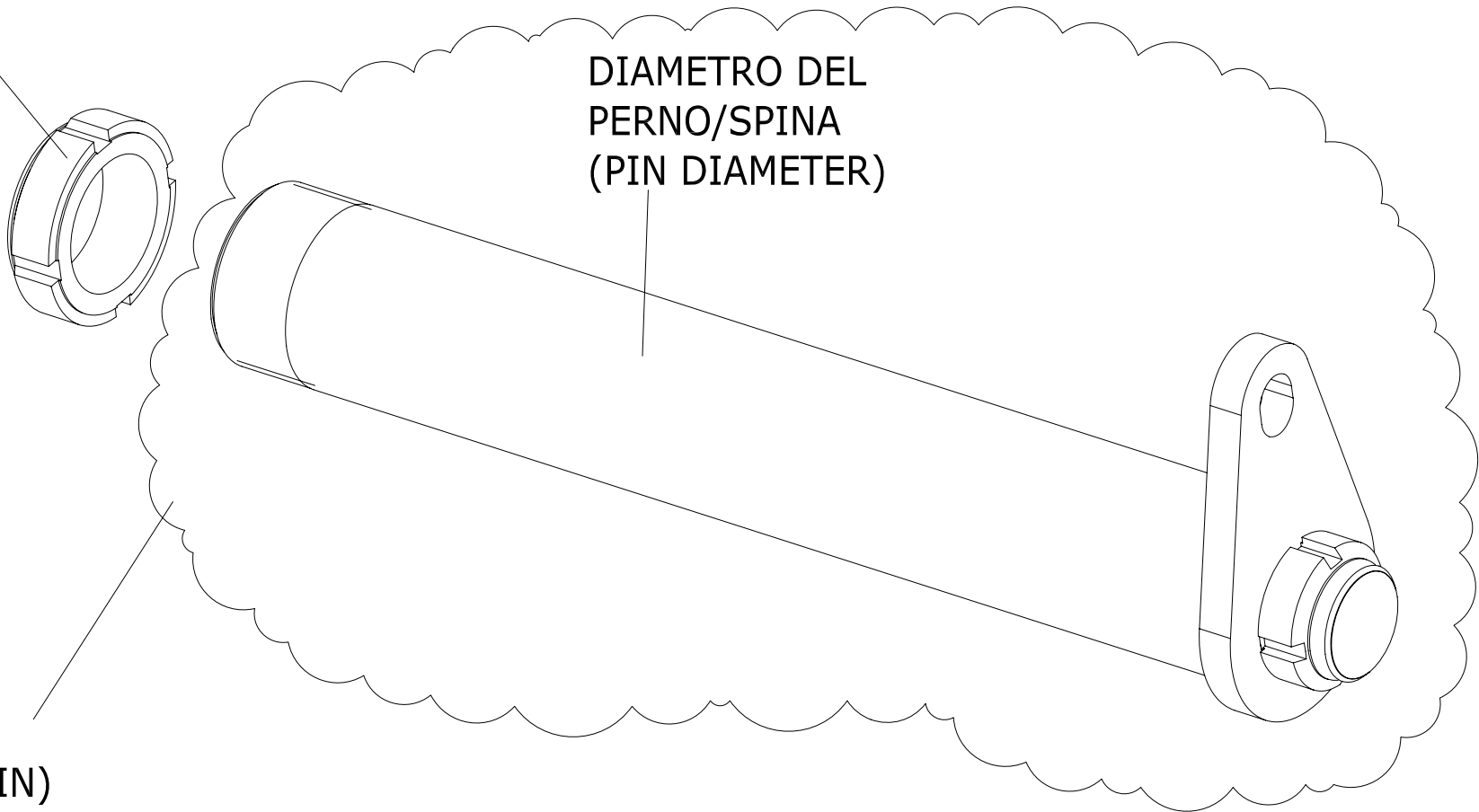



PERNO/SPINA (PIN)



IL CODICE DEL PERNO A RICAMBIO COMPRENDE LA GOCCIA MONTATA E LA GHIERA DI FISSAGGIO DELLA GOCCIA



THE CODE OF A PIN INCLUDES DROP PARTS MOUNTED AND THE LOCK NUT TO FIXING THE DROP, ALL THESE PARTS ARE SHIPPED ALREADY MOUNTED TOGETHER



<b>DIAMETRO DEL PERNO/SPINA mm SISTEMA METRICO (PIN DIAMETER mm METRIC)</b>	<b>GHIERA (LOCKNUTS CODE)</b>	<b>DADO (NUTS CODE)</b>
25	BG4	
30	BG5	
35	BG3	
40	BG2	
45	BG7	
50	BG8	
20 (DIAMETER OF THREADED PART M17 PITCH=1)	BG1	
20 (DIAMETER OF THREADED PART M20 PITCH=1)	BG6	
20 (DIAMETER OF THREADED PART M20 PITCH=1,5)	BG12	

POS	Codice	U.M.	 Descrizione	 Description
BC1	BC000100	NR	COPPIGLIA 4X40	COTTER PIN 4x40
BC2	BC000200	NR	COPPIGLIA 5X40	COTTER PIN 5x40
BC3	BC000300	NR	SEEGER ESTERNO Ø20	SEEGER EXTERNAL Ø20
BC4	BC000400	NR	SEEGER ESTERNO Ø8	SEEGER EXTERNAL Ø8
BD1	BD000100	NR	Dado Esagonale Flangiato Liscio PG DIN 6923 CI 8 M 14 Z.Bianca	Hex Flange Nut DIN 6923 CI Smooth PG 8 M 14 Z. white
BD2	BD000200	NR	Dado Esagonale Basso PG DIN 936 CI 04 M 8 Z.Bianca	Low Hex nut DIN 936 PG 04 M CI 8 Z. white
BD3	BD000300	NR	Dado Esagonale Alto PG UNI 5587 CI 8 M 8 Z.Bianca	Hex Nut High PG UNI 5587 CI 8 M 8 Z. white
BD4	BD000400	NR	Dado Alto Autobloccante PG DIN 982 CI 8 M 12 Z.Bianca	High Self Locking Nut DIN 982 PG 12 CI 8 M Z. white
BD5	BD000500	NR	Dado Alto Autobloccante PG DIN 982 CI 8 M 8 Z.Bianca	High Self Locking Nut DIN 982 PG CI 8 M 8 Z. white
BD6	BD000600	NR	Dado Esagonale Alto PG UNI 5587 CI 8 M 4 Z.Bianca	Hex Nut High PG UNI 5587 M 4 CI 8 Z. white
BD7	BD000700	NR	Dado Esagonale Basso PG DIN 936 CI 04 M 6 Z.Bianca	Low Hex nut DIN 936 PG 6 CI 04 M Z. white
BD8	BD000800	NR	Dado Basso Autobloccante PG DIN 985 CI 8 M 6 Z.Bianca	Low Self-locking nut DIN 985 PG 6 CI 8 M Z. white
BD9	BD000900	NR	Dado Alto Autobloccante PG DIN 982 CI 8 M 6 Z.Bianca	High Self Locking Nut DIN 982 PG CI 8 M6 Z. white
BD10	BD001000	NR	Dado Basso Autobloccante PG DIN 985 CI 8 M 5 Z.Bianca	Low Self-locking nut DIN 985 PG CI 8 M5 Z. white
BD11	BD001100	NR	Dado Alto Autobloccante PG DIN 982 CI 8 M 5 Z.Bianca	High Self Locking Nut DIN 982 PG CI 8 M5 Z. white
BD12	BD001200	NR	Dado Alto Autobloccante PG DIN 982 CI 8 M 4 Z.Bianca	High Self Locking Nut DIN 982 PG CI 8 M4 Z. white
BD13	BD001300	NR	Dado Alto Autobloccante PG DIN 982 CI 8 M 3 Z.Bianca	High Self Locking Nut DIN 982 PG CI 8 M3 Z. white



POS	Codice	U.M.	 Descrizione	 Description
BD14	BD001400	NR	Dado Alto Autobloccante PF DIN 982 CI 8 M 20 x 1,5 Z.Bianca	High Self Locking Nut DIN 982 PF CI 8 M 20 x 1.5 Z white
BD15	BD001500	NR	Dado Alto Autobloccante PG DIN 982 CI 8 M 10 Z.Bianca	High Self Locking Nut DIN 982 PG CI 8 M10 Z. white
BD16	BD001600	NR	Dado Esagonale Alto PG UNI 5587 CI 8 M 3 Z.Bianca	Hex Nut High PG UNI 5587 CI 8 M3 Z. white
BD17	BD001700	NR	Dado Basso Autobloccante PG DIN 985 CI 8 M 8 Z.Bianca	Low Self-locking nut DIN 985 PG CI 8 M8 Z. white
BD18	BD001800	NR	Dado Alto Autobloccante PG DIN 982 CI 8 M 16 Z.Bianca	High Self Locking Nut DIN 982 PG CI 8 M16 Z. white
BD19	BD001900	NR	Dado Alto Autobloccante PF DIN 982 CI 8 M 20 x 1,5 Z.Bianca H=20 ribassato	High Self Locking Nut DIN 982 PF CI 8 M 20 x 1.5 Z White H = 20 low
BD22	BD002200	NR	Dado Alto Autobloccante PG DIN 982 CI 8 M 14 Z.Bianca	Hex Flange Nut DIN 982 CI 8 M 14 Z. white
BD23	BD002300	NR	Dado Basso Autobloccante PG DIN 985 CI 8 M 10 Z.Bianca	Low Self-locking nut DIN 985 PG CI 8 M 10 Z. white
BD24	BD002400	NR	Dado Alto Autobloccante PG DIN 982 CI 8 M 24 Z.Bianca	High Self Locking Nut DIN 982 PG CI 8 M24 Z. white
BD25	BD002500	NR	Dado Esagonale Alto PG UNI 5587 CI 8 M 6 Z.Bianca	Hex Nut High PG UNI 5587 M 6 CI 8 Z. white
BD26	BD002600	NR	Dado Esagonale Alto PG UNI 5587 CI 8 M 10 Z.Bianca	Hex Nut High PG UNI 5587 M 10 CI 8 Z. white
BD27	BD002700	NR	Dado Alto Autobloccante PG DIN 982 CI 8 M 18 Z.Bianca	High Self Locking Nut DIN 982 PG CI 8 M18 Z. white
BD28	BD002800	NR	Dado Basso Autobloccante PG DIN 985 CI 8 M 16 Z.Bianca	Low Self-locking nut DIN 985 PG CI 8 M 16 Z. white
BD29	BD002900	NR	Dado Esagonale Alto PG UNI 5587 CI 8 M 5 Z.Bianca	Hex Nut High PG UNI 5587 M 5 CI 8 Z. white
BD30	BD003000	NR	Dado Esagonale Alto PG UNI 5587 CI 12 M 5 Z.Bianca	Hex Nut High PG UNI 5587 M 5 CI 12 Z. white
BD31	BD003100	NR	Dado Esagonale Alto PG UNI 5587 CI 16 M 5 Z.Bianca	Hex Nut High PG UNI 5587 M 5 CI 16 Z. white
BD32	BD003200	NR	Dado Alto Autobloccante PG DIN 982 CI 8 M 20 Z.Bianca	High Self Locking Nut DIN 982 PG CI 8 M20 Z. white

POS	Codice	U.M.	 Descrizione	 Description
BG1	BG000100	NR	Ghiera autobloccante GN CI 6 GN 3 D. 17 x 1 Z.Bianca	Self-locking nut GN GN 3 CI 6 D. 17 x 1 Z. white
BG2	BG000200	NR	Ghiera autobloccante pesante CI 6 GUP 40 x 1,5 Z.Bianca	Self-locking nut heavy CI 6 GUP 40 x 1.5 Z white
BG3	BG000300	NR	Ghiera autobloccante pesante CI 6 GUP 35 x 1,5 Z.Bianca	Self-locking nut heavy CI 6 GUP 35 x 1.5 Z white
BG4	BG000400	NR	Ghiera autobloccante pesante CI 6 GUP 25 x 1,5 Z.Bianca	Self-locking nut heavy CI 6 GUP 25 x 1.5 Z white
BG5	BG000500	NR	Ghiera autobloccante pesante CI 6 GUP 30 x 1,5 Z.Bianca	Self-locking nut heavy CI 6 GUP 30 x 1.5 Z white
BG6	BG000600	NR	Ghiera autobloccante pesante CI 6 GUP 20 x 1 Z.Bianca	Self-locking nut heavy CI 6 GUP 20 x 1 Z. white
BG7	BG000700	NR	Ghiera autobloccante GN CI 6 GN 3 D. 45 x 1,5 Z.Bianca	NUT
BG8	BG000800	NR	Ghiera autobloccante GN CI 6 GN 3 D. 50 x 1,5 Z.Bianca	NUT
BG9	BG000900	NR	Ghiera autobloccante GN CI 6 GN 3 D. 20 x 1,5 Z.Bianca	NUT
BG10	BG001000	NR	Ghiera autobloccante ribassata CI 6 GUK 25 x 1,5 Z.Bianca	Self-locking nut lowered CI 6 GUK 25 x 1.5 Z.Bianca
BG11	BG001100	NR	Ghiera autobloccante ribassata CI 6 GUK 20 x 1 Z.Bianca	Self-locking nut lowered CI 6 GUK 20 x 1 Z.Bianca
BG12	BG001200	NR	Ghiera autobloccante ribassata CI 6 GUA 20 x 1.5 Z.Bianca	Self-locking nut lowered CI 6 GUA 20 x 1.5 Z.Bianca
BG13	BG001300	NR	Ghiera autobloccante ribassata CI 6 GUK 30 x 1.5 Z.Bianca	Self-locking nut lowered CI 6 GUK 30 x 1.5 Z.Bianca
BG14	BG001400	NR	Ghiera autobloccante ribassata CI 6 GUK 45 x 1.5 Z.Bianca	Self-locking nut lowered CI 6 GUK 45 x 1.5 Z.Bianca
BG15	BG001500	NR	Ghiera autobloccante ribassata CI 6 GUK 50 x 1.5 Z.Bianca	Self-locking nut lowered CI 6 GUK 50 x 1.5 Z.Bianca
BG16	BG001600	NR	Ghiera autobloccante ribassata CI 6 GUK 55 x 1.5 Z.Bianca	Self-locking nut lowered CI 6 GUK 55 x 1.5 Z.Bianca
BI1	BI000100	NR	INSERTO ESAGONALE M6	INSERT HEX M6
BI2	BI000200	NR	INSERTO ESAGONALE M5	INSERT HEX M5

POS	Codice	U.M.	 Descrizione	 Description
BR1	BR000100	NR	Grower sez.rett.spigoli vivi pesante UNI 9195 Acc.Molle D 6 Z.D.Bianca	Grower sez.rett. sharp heavy UNI 9195 Acc.Molle D 6 Z.D. white
BR2	BR000200	NR	Rondella Piana DIN 125-A HV100 D 4 Z.Bianca	Plain washer DIN 125-A HV100 D 4 Z. white
BR3	BR000300	NR	Rondella Piana DIN 125-A HV100 D 5 Z.Bianca	Plain washer DIN 125-A HV100 D 5 Z. white
BR4	BR000400	NR	Rondella Piana DIN 125-A HV100 D 6 Z.Bianca	Plain washer DIN 125-A HV100 D 6 Z. white
BR5	BR000500	NR	Rondella Piana DIN 125-A HV100 D 8 Z.Bianca	Plain washer DIN 125-A HV100 D 8 Z. white
BR6	BR000600	NR	Rondella Piana DIN 125-A HV100 D 10 Z.Bianca	Plain washer DIN 125-A HV100 D 10 Z. white
BR7	BR000700	NR	Rondella Piana DIN 125-A HV100 D 12 Z.Bianca	Plain washer DIN 125-A HV100 D 12 Z. white
BR8	BR000800	NR	Rosetta piana fascia larga e=3d DIN 9021 HV100 D 10 x 30 x 2,5 Z.Bianca	Wide band and flat washer DIN 9021 HV100 3d = D 10 x 30 x 2.5 Z white
BR9	BR000900	NR	Rosetta piana fascia larga e=3d DIN 9021 HV100 D 12 x 36 x 2,5 Z.Bianca	Wide band and flat washer DIN 9021 HV100 3d = D 12 x 36 x 2.5 Z white
BR10	BR001000	NR	Rondella x Carpenteria DIN 6916 HV 300 D 16 Z.Bianca	Carpentry washer DIN 6916 HV 300 D 16 Z white
BR11	BR001100	NR	Rosette speciali HV100 D 25 x 51 x 1 Z.Bianca	Special washers HV100 D 25 x 51 x 1 Z. white
BR13	BR001300	NR	Rondella dentellatura esterna DIN 6798-A Acc.Molle D 3 Z.D.Bianca	Washer external serration DIN 6798-A Acc.Molle D 3 ZD white
BR14	BR001400	NR	Rosetta piana fascia larga e=3d DIN 9021 HV100 D 5 x 15 x 1,2 Z.Bianca	Wide band and flat washer DIN 9021 HV100 3d = D 5 x 15 x 1.2 Z whit
BR15	BR001500	NR	Rosetta piana fascia larga e=3d DIN 9021 HV100 D 6 x 18 x 1,5 Z.Bianca	Wide band and flat washer DIN 9021 HV100 3d = D 6 x 18 x 1.5 Z white
BR16	BR001600	NR	Rosetta piana fascia larga e=3d DIN 9021 HV100 D 8 x 24 x 2 Z.Bianca	Wide band and flat washer DIN 9021 HV100 3d = D 8 x 24 x 2 Z. white
BR17	BR001700	NR	Rosetta piana fascia larga e=3d DIN 9021 HV100 D 4 x 12 x 1 Z.Bianca	Wide band and flat washer DIN 9021 HV100 D = 3d 4 x 12 x 1 Z. white

POS	Codice	U.M.	 Descrizione	 Description
BR18	BR001800	NR	Rondella Piana DIN 125-A NYLON D 4	Plain washer DIN 125-A NYLON D 4
BR19	BR001900	NR	Rondella Piana DIN 125-A HV100 D 3 Z.Bianca	Plain washer DIN 125-A HV100 D 3 Z. white
BR20	BR002000	NR	Rondella Piana DIN 125-A HV100 D 16 Z.Bianca	Plain washer DIN 125-A HV100 D 16 Z. white
BR21	BR002100	NR	Rosetta piana fascia larga e=3d DIN 9021 HV100 D 16 x 48 x 4 Z.Bianca	Wide band and flat washer DIN 9021 HV100 3d = D 16 x 48 x 4 Z. white
BR22	BR002200	NR	Grower sez.rett.spigoli vivi pesante UNI 9195 Acc.Molle D 8 Z.D.Bianca	Grower section. rect. sharp heavy UNI 9195 Stainless Springs D 8 Z.D. white
BR23	BR002300	NR	Rosetta piana fascia larga e=3d DIN 9021 HV100 D 3 x 12 x 1 Z.Bianca	Wide band and flat washer DIN 9021 HV100 D = 3d 3 x 12 x 1 Z. white
BR24	BR002400	NR	Rosetta piana fascia larga e=3d DIN 9021 HV100 D 14 x 42 x 3 Z.Bianca	Wide band and flat washer DIN 9021 HV100 D = 3d 14 x 42 x 3 Z. white
BR25	BR002500	NR	Grower sez.rett.spigoli vivi pesante UNI 9195 Acc.Molle D 10 Z.D.Bianca	Grower sez.rett. sharp heavy UNI 9195 Acc.Molle D 10 Z.D. white
BR26	BR002600	NR	Rondella Piana DIN 125-A D 30 Z.Bianca	Plain washer DIN 125-A D 30 Z. white
BR27	BR002700	NR	Rondella Piana DIN 125-A HV100 D 14 Z.Bianca	Plain washer DIN 125-A HV100 D 14 Z. white
BR28	BR002800	NR	Rosetta piana fascia larga D 6 x 24 x 2 Z.Bianca	Wide band and flat washer D 6 x 24 x 2 Z white
BR29	BR002900	NR	Rondella Piana DIN 125-A HV100 D 18 Z.Bianca	Plain washer DIN 125-A HV100 D 18 Z. white
BR30	BR003000	NR	Rondella Piana DIN 125-A HV100 D 20 Z.Bianca	Plain washer DIN 125-A HV100 D 20 Z. white
BR31	BR003100	NR	Grower sez.rett.spigoli vivi pesante UNI 9195 Acc.Molle D 12 Z.D.Bianca	Grower sez.rett. sharp heavy UNI 9195 Acc.Molle D 12 Z.D. white
BR32	BR003200	NR	Rosette speciali HV100 D 30 x 42 x 0.5 Z.Bianca	Special washers HV100 D 30 x 42 x 0.5 Z. white
BR33	BR003300	NR	Rosette speciali HV100 D 30 x 61 x 1 Z.Bianca	Special washers HV100 D 30 x 61 x 1 Z. white
BR34	BR003400	NR	Rosette speciali HV100 D 42 x 52 x 0.2 Z.Bianca	Special washers HV100 D 42 x 52 x 0.2 Z. white



POS	Codice	U.M.	 Descrizione	 Description
BR35	BR003500	NR	Rosette speciali HV100 D 42 x 52 x 0.3 Z.Bianca	Special washers HV100 D 42 x 52 x 0.3 Z. white
BR36	BR003600	NR	Rosette speciali HV100 D 42 x 52 x 1 Z.Bianca	Special washers HV100 D 42 x 52 x 1 Z. white
BR37	BR003700	NR	Rosette speciali HV100 D 42 x 52 x 1.5 Z.Bianca	Special washers HV100 D 42 x 52 x 1.5 Z. white
BR38	BR003800	NR	Rosette speciali HV100 D 42 x 52 x 2 Z.Bianca	Special washers HV100 D 42 x 52 x 2 Z. white
BR39	BR003900	NR	Rosetta piana fascia larga e=3d DIN 9021 HV100 D 18 x 48 x 4 Z.Bianca	Wide band and flat washer DIN 9021 HV100 3d = D 18 x 48 x 4 Z. white
BR40	BR004000	NR	Rosetta SCHNORR zincate D 6	washer SCHNORR galvanized D 6
BR41	BR004100	NR	Grower sez.rett.spigoli vivi pesante UNI 9195 Acc.Molle D 14 Z.D.Bianca	Grower sez.rett. sharp heavy UNI 9195 Acc.Molle D 14 Z.D. white
BR42	BR004200	NR	Rondella x Carpenteria DIN 6916 HV 300 D 14 Z.Bianca	Carpentry washer DIN 6916 HV 300 D 14 Z white
BS1	BS000100	NR	GRANO FILETTATO M6X12	WHEAT THREAD M6X12
BS2	BS000200	NR	SPINA CIL. 8x16 UNI 6364-A h6 CMT + TMP	PIN CYLINDER 8 x 16 UNI 6364-A CMT h6 + TMP
BS3	BS000300	NR	PRIGIONIERO M10X35	STUD M10X35
BV1	BV000100	NR	Vite TE Parziale Filetto PG DIN 931 CI 8.8 M 8 x 80 Z.Bianca	Screw Partial Thread DIN 931 PG CI 8.8 M 8 x 80 Z. white
BV2	BV000200	NR	Vite TE Tutto Filetto PG DIN 933 CI 8.8 M 8 x 60 Z.Bianca	Screw All Thread DIN 933 PG CI 8.8 M 8 x 60 Z. white
BV3	BV000300	NR	Vite TCEI PG DIN 912 CI 8.8 M 8 x 60 Z.Bianca	Screw DIN 912 PG CI 8.8 M8 x 60 Z. white
BV4	BV000400	NR	Vite TE Parziale Filetto PG DIN 931 CI 8.8 M 8 x 50 Z.Bianca	Screw Partial Thread DIN 931 PG CI 8.8 M 8 x 50 Z. white
BV5	BV000500	NR	Vite TCEI PG DIN 912 CI 8.8 M 8 x 45 Z.Bianca	Screw DIN 912 PG CI 8.8 M8 x 45 Z. white
BV6	BV000600	NR	Vite TCEI PG DIN 912 CI 8.8 M 8 x 40 Z.Bianca	Screw DIN 912 PG CI 8.8 M8 x 40 Z.Bianca

POS	Codice	U.M.	 Descrizione	 Description
BV7	BV000700	NR	Vite TE Tutto Filetto PG DIN 933 CI 8.8 M 8 x 35 Z.Bianca	Screw All Thread DIN 933 PG CI 8.8 M 8 x 35 Z. white
BV8	BV000800	NR	Vite TE Tutto Filetto PG DIN 933 CI 8.8 M 8 x 30 Z.Bianca	Screw All Thread DIN 933 PG CI 8.8 M 8 x 30 Z. white
BV9	BV000900	NR	Vite TE Tutto Filetto PG DIN 933 CI 8.8 M 8 x 25 Z.Bianca	Screw All Thread DIN 933 PG CI 8.8 M 8 x 25 Z. white
BV10	BV001000	NR	Vite TCEI PG DIN 912 CI 8.8 M 8 x 25 Z.Bianca	Screw DIN 912 PG CI 8.8 M8 x 25 Z. white
BV11	BV001100	NR	Vite TE Tutto Filetto PG DIN 933 CI 8.8 M 8 x 20 Z.Bianca	Screw All Thread DIN 933 PG CI 8.8 M 8 x 20 Z. white
BV12	BV001200	NR	Vite TE Tutto Filetto PG DIN 933 CI 8.8 M 8 x 16 Z.Bianca	Screw All Thread DIN 933 PG CI 8.8 M 8 x 16 Z. white
BV13	BV001300	NR	Vite TCEI PG DIN 912 CI 8.8 M 8 x 16 Z.Bianca	Screw DIN 912 PG CI 8.8 M8 x 16 Z. white
BV14	BV001400	NR	Vite TE Tutto Filetto PG DIN 933 CI 8.8 M 8 x 14 Z.Bianca	Screw All Thread DIN 933 PG CI 8.8 M 8 x 14 Z. white
BV15	BV001500	NR	Vite TCEI PG DIN 912 CI 8.8 M 6 x 45 Z.Bianca	Screw DIN 912 M6 x 45 CI 8.8 Z. white
BV16	BV001600	NR	Vite TCEI PG DIN 912 CI 8.8 M 6 x 30 Z.Bianca	Screw DIN 912 M6 x 30 CI 8.8 Z. white
BV17	BV001700	NR	Vite TSPEI PG DIN 7991 CI 10.9 M 6 x 30 Z.Bianca	screw DIN 7991 CI 10.9 M 6 x 30 Z. white
BV18	BV001800	NR	Vite TE Tutto Filetto PG DIN 933 CI 8.8 M 6 x 30 Z.Bianca	Screw All Thread DIN 933 PG CI 8.8 M 6 x 30 Z. white
BV19	BV001900	NR	Vite TBEI PG ISO 7380 CI 10.9 M 6 x 30 Z.Bianca	screw ISO 7380 CI 10.9 M 6 x 30 Z. white
BV20	BV002000	NR	Vite TE Tutto Filetto PG DIN 933 CI 8.8 M 6 x 12 Z.Bianca	Screw All Thread DIN 933 PG CI 8.8 M 6 x 12 Z. white
BV21	BV002100	NR	Vite TCEI PG DIN 912 CI 8.8 M 6 x 12 Z.Bianca	Screw DIN 912 PG CI 8.8 M 6 x 12 Z. white
BV22	BV002200	NR	Vite TCEI PG DIN 912 CI 8.8 M 5 x 45 Z.Bianca	Screw DIN 912 PG CI 8.8 M 5 x 45 Z. white
BV23	BV002300	NR	Vite TE UNF ANSI B18.2.1 GR.5 5/16 x 1" Z.Bianca	Screw UNF ANSI B18.2.1 GR.5 5/16 x 1 "Z. White
BV24	BV002400	NR	Vite TC Croce PG DIN 7985 CI 4.8 M 4 x 8 Z.Bianca	Cross head screw DIN 7985 PG CI 4.8 M 4 x 8 Z. white

POS	Codice	U.M.	 Descrizione	 Description
BV25	BV002500	NR	Vite TCEI PG DIN 912 CI 8.8 M 4 x 16 Z.Bianca	Screw DIN 912 PG CI 8.8 M 4 x 16 Z. white
BV26	BV002600	NR	Vite TCEI PG DIN 912 CI 8.8 M 6 x 50 Z.Bianca	Screw DIN 912 PG CI 8.8 M 6 x 50 Z. white
BV27	BV002700	NR	Vite TSPEI PG DIN 7991 CI 10.9 M 6 x 40 Z.Bianca	screw DIN 7991 CI 10.9 M 6 x 40 Z. white
BV28	BV002800	NR	Vite TSPEI PG DIN 7991 CI 10.9 M 6 x 25 Z.Bianca	screw DIN 7991 CI 10.9 M 6 x 25 Z. white
BV29	BV002900	NR	Vite TE Tutto Filetto PG DIN 933 CI 8.8 M 6 x 25 Z.Bianca	Screw All Thread DIN 933 PG CI 8.8 M 6 x 25 Z. white
BV30	BV003000	NR	Vite TE Tutto Filetto PG DIN 933 CI 8.8 M 6 x 22 Z.Bianca	Screw All Thread DIN 933 PG CI 8.8 M 6 x 22 Z. white
BV31	BV003100	NR	Vite TSPEI PG DIN 7991 CI 10.9 M 6 x 20 Z.Bianca	screw DIN 7991 CI 10.9 M 6 x 20 Z. white
BV32	BV003200	NR	Vite TE Tutto Filetto PG DIN 933 CI 8.8 M 6 x 20 Z.Bianca	Screw All Thread DIN 933 PG CI 8.8 M 6 x 20 Z. white
BV33	BV003300	NR	Vite TCEI PG DIN 912 CI 8.8 M 6 x 20 Z.Bianca	Screw DIN 912 PG CI 8.8 M 6 x 20 Z. white
BV34	BV003400	NR	Vite TE Tutto Filetto PG DIN 933 CI 8.8 M 6 x 16 Z.Bianca	Screw All Thread DIN 933 PG CI 8.8 M 6 x 16 Z. white
BV35	BV003500	NR	Vite TBEI PG ISO 7380 CI 10.9 M 6 x 16 Z.Bianca	screw ISO 7380 CI 10.9 M 6 x 16 Z. white
BV36	BV003600	NR	Vite TCEI PG DIN 912 CI 8.8 M 5 x 8 Z.Bianca	Screw DIN 912 PG CI 8.8 M 5 x 8 Z. white
BV37	BV003700	NR	Vite TSPEI PG DIN 7991 CI 10.9 M 5 x 60 Z.Bianca	screw DIN 7991 CI 10.9 M 5 x 60 Z. white
BV38	BV003800	NR	Vite TE Parziale Filetto PG DIN 931 CI 8.8 M 5 x 60 Z.Bianca	Screw Partial Thread DIN 931 PG CI 8.8 M 5 x 60 Z. white
BV39	BV003900	NR	Vite TCEI PG DIN 912 CI 8.8 M 5 x 60 Z.Bianca	Screw DIN 912 PG CI 8.8 M 5 x 60 Z. white
BV40	BV004000	NR	Vite TE Parziale Filetto PG DIN 931 CI 8.8 M 5 x 55 Z.Bianca	Screw Partial Thread DIN 931 PG CI 8.8 M 5 x 55 Z. white
BV41	BV004100	NR	Vite TE Tutto Filetto PG DIN 933 CI 8.8 M 5 x 16 Z.Bianca	Screw All Thread DIN 933 PG CI 8.8 M 5 x 16 Z. white
BV42	BV004200	NR	Vite TC Croce PG DIN 7985 CI 4.8 M 5 x 16 Z.Bianca	Cross head screw DIN 7985 PG CI 4.8 M 5 x 16 Z. white

POS	Codice	U.M.	 Descrizione	 Description
BV43	BV004300	NR	Vite TE Tutto Filetto PG DIN 933 CI 8.8 M 5 x 12 Z.Bianca	Screw All Thread DIN 933 PG CI 8.8 M 5 x 12 Z. white
BV44	BV004400	NR	Vite TE UNF ANSI B18.2.1 GR.5 5/16 x 1"1/4 Z.Bianca	Screw UNF ANSI B18.2.1 GR.5 5/16 x 1 "1/4 Z. White
BV45	BV004500	NR	Vite TE UNF ANSI B18.2.1 GR.5 5/16 x 1"1/4 Z.Bianca	Screw UNF ANSI B18.2.1 GR.5 5/16 x 1 "1/4 Z. White
BV46	BV004600	NR	Vite TCEI PG DIN 912 CI 8.8 M 4 x 40 Z.Bianca	Screw DIN 912 PG CI 8.8 M 4 x 40 Z. white
BV47	BV004700	NR	Vite Trilob. Autoform. TC Croce PG DIN 7500-C C15 M 4 x 40 Z.Bianca	Trilob Screw. Autoform. TC Cross PH DIN 7500-C C 15 M 4 x 40 Z. white
BV48	BV004800	NR	Vite Trilob. Autoform. TC Croce PG DIN 7500-C C15 M 4 x 20 Z.Bianca	Trilob Screw. Autoform. TC Cross PG DIN 7500-C C15 M 4 x 20 Z. white
BV49	BV004900	NR	Vite TC Croce PG DIN 7985 CI 4.8 M 4 x 16 Z.Bianca	Cross head screw DIN 7985 PG CI 4.8 M 4 x 16 Z. white
BV50	BV005000	NR	VITE AUTOFIETTANTE TE C/BORDINO DIN 6928 C15 4,8X50 Z.Bianca	TAPPING SCREW TE C / BORDINO DIN 6928 C15 4.8 X50 Z. white
BV51	BV005100	NR	VITE AUTOFIETTANTE TE C/BORDINO DIN 6928 C15 4,8X25 Z.Bianca	TAPPING SCREW TE C / BORDINO DIN 6928 C15 4.8 X25 Z. white
BV52	BV005200	NR	Vite TCEI PG DIN 912 CI 12.9 M 3 x 25 Z.D.Bianca	Screw DIN 912 M 3 CI 12.9 x 25 Z.D. white
BV53	BV005300	NR	Vite TSPEI PG DIN 7991 CI 10.9 M 3 x 14 Z.Bianca	Screw DIN 7991 CI 10.9 M 3 x 14 Z. white
BV54	BV005400	NR	Vite Autofil.TC Croce DIN 7981 C15 3,5 x 6,5 Z.Bianca	Autofil.TC Cross Screw DIN 7981 C15 3.5 x 6.5 Z. white
BV55	BV005500	NR	Vite TE Parziale Filetto PG DIN 931 CI 10.9 M 16 x 55 Z.D.Bianca	Screw Partial Thread DIN 931 PG CI 10.9 M 16 x 55 ZD white
BV56	BV005600	NR	Vite TE Tutto Filetto PG DIN 933 CI 8.8 M 16 x 40 Z.Bianca	Screw All Thread DIN 933 PG CI 8.8 M 16 x 40 Z. white
BV57	BV005700	NR	Vite TE Parziale Filetto PG DIN 931 CI 10.9 M 16 x 220 Z.Deidro Bianche	Screw Partial Thread DIN 931 PG CI 10.9 M 16 x 220 Z. dehydro White
BV58	BV005800	NR	Vite TE 8.8 DIN933 M16x20 Testa Alta 8 Zn Bianca	Screw M16x20 DIN933 8.8 Head High 8 Zn White
BV59	BV005900	NR	Vite TE Tutto Filetto PG DIN 933 CI 8.8 M 12 x 16 Z.Bianca	Screw All Thread DIN 933 PG CI 8.8 M 12 x 16 Z. white

POS	Codice	U.M.	 Descrizione	 Description
BV60	BV006000	NR	Vite TE Parziale Filetto PG DIN 931 CI 8.8 M 12 x 120 Z.Bianca	Screw Partial Thread DIN 931 PG CI 8.8 M 12 x 120 Z. white
BV61	BV006100	NR	Vite TE Parziale Filetto PG DIN 931 CI 8.8 M 10 x 50 Z.Bianca	Screw Partial Thread DIN 931 PG CI 8.8 M 10 x 50 Z. white
BV62	BV006200	NR	Vite TE Tutto Filetto PG DIN 933 CI 8.8 M 10 x 35 Z.Bianca	Screw All Thread DIN 933 PG CI 8.8 M 10 x 35 Z. white
BV63	BV006300	NR	Vite TSPEI PG DIN 7991 CI 10.9 M 10 x 30 Z.Bianca	Screw DIN 7991 CI 10.9 M 10 x 30 Z. white
BV64	BV006400	NR	Vite TE Tutto Filetto PG DIN 933 CI 8.8 M 10 x 30 Z.Bianca	Screw All Thread DIN 933 PG CI 8.8 M 10 x 30 Z. white
BV65	BV006500	NR	Vite TCEI PG DIN 912 CI 12.9 M 10 x 25 Geo 321 A	Screw DIN 912 PG CI 12.9 M 10 x 25 Geo 321 A
BV66	BV006600	NR	Vite TCEI PG DIN 912 CI 8.8 M 10 x 25 Z.Bianca	Screw DIN 912 PG CI 8.8 M 10 x 25 Z. white
BV67	BV006700	NR	Vite TE Tutto Filetto PG DIN 933 CI 8.8 M 10 x 20 Z.Bianca	Screw All Thread DIN 933 PG CI 8.8 M 10 x 20 Z. white
BV68	BV006800	NR	Vite TE Tutto Filetto PG DIN 933 CI 8.8 M 10 x 18 Z.Bianca	Screw All Thread DIN 933 PG CI 8.8 M 10 x 18 Z. white
BV69	BV006900	NR	Vite Trilob. Autoform. TSP Croce PG DIN 7500-M C15 M 5 x 16 Z.Bianca	Trilob Screw. Autoform. TSP Cross PG DIN 7500-M C15 M 5 x 16 Z. white
BV70	BV007000	NR	Vite TE Parziale Filetto PG DIN 931 CI 8.8 M 8 x 70 Z.Bianca	Screw Partial Thread DIN 931 PG CI 8.8 M 8 x 70 Z. white
BV71	BV007100	NR	Vite TE Parziale Filetto PG DIN 931 CI 8.8 M 8 x 65 Z.Bianca	Screw Partial Thread DIN 931 PG CI 8.8 M 8 x 65 Z. white
BV72	BV007200	NR	Vite TE Parziale Filetto PG DIN 931 CI 8.8 M 6 x 55 Z.Bianca	Screw Partial Thread DIN 931 PG CI 8.8 M 6 x 55 Z. white
BV73	BV007300	NR	Vite TCEI PG DIN 912 CI 8.8 M 6 x 55 Z.Bianca	Screw DIN 912 PG CI 8.8 M 6 x 55 Z. white
BV74	BV007400	NR	Vite TCEI PG DIN 912 CI 8.8 M 6 x 16 Z.Bianca	Screw DIN 912 PG CI 8.8 M 6 x 16 Z. white
BV75	BV007500	NR	Vite TSPEI PG DIN 7991 CI 10.9 M 6 x 10 Z.Bianca	Screw DIN 7991 CI 10.9 M 6 x 10 Z. white
BV76	BV007600	NR	Vite TCEI PG DIN 912 CI 8.8 M 5 x 55 Z.Bianca	Screw DIN 912 PG CI 8.8 M 5 x 55 Z. white

POS	Codice	U.M.	 Descrizione	 Description
BV77	BV007700	NR	Vite TC Croce PG DIN 7985 CI 4.8 M 6 x 16 Z.Bianca	Cross head screw DIN 7985 PG CI 4.8 M 6 x 16 Z. white
BV78	BV007800	NR	Vite Trilob. Autoform. TC Croce PG DIN 7500-C C15 M 5 x 12 Z.Bianca	Trilob Screw. Autoform. TC Cross PG DIN 7500-C C15 M 5 x 12 Z. white
BV79	BV007900	NR	Vite TE Tutto Filetto PG DIN 933 CI 8.8 M 4 x 35 Z.Bianca	Screw All Thread DIN 933 PG CI 8.8 M 4 x 35 Z. white
BV80	BV008000	NR	VITE AUTOFIETTANTE TE C/BORDINO DIN 6928 C15 4,8X35 Z.Bianca	TAPPING SCREW TE C / BORDINO DIN 6928 C15 4.8 X35 Z. white
BV81	BV008100	NR	Vite TCEI PG DIN 912 CI 12.9 M 3 x 14 Z.D.Bianca	Screw DIN 912 M 3 CI 12.9 x 14 Z.D. white
BV82	BV008200	NR	Vite TE Parziale Filetto PG DIN 931 CI 8.8 M 16 x 70 Z.Bianca	Screw Partial Thread DIN 931 PG CI 8.8 M 16 x 70 Z. white
BV83	BV008300	NR	Vite TE Parziale Filetto PG DIN 931 CI 8.8 M 16 x 260 Z.Bianca	Screw Partial Thread DIN 931 PG CI 8.8 M 16 x 260 Z. white
BV84	BV008400	NR	Vite TE Parziale Filetto PG DIN 931 CI 8.8 M 12 x 110 Z.Bianca	Screw Partial Thread DIN 931 PG CI 8.8 M 12 x 110 Z. white
BV85	BV008500	NR	Vite TE Tutto Filetto PG DIN 933 CI 8.8 M 10 x 40 Z.Bianca	Screw Thread DIN 933 PG CI 8.8 M 10 x 40 Z. white
BV86	BV008600	NR	Vite TCEI PG DIN 912 CI 8.8 M 8 x 65 Z.Bianca	Screw DIN 912 PG CI 8.8 M 8 x 65 Z. white
BV87	BV008700	NR	Vite TCEI PG DIN 912 CI 8.8 M 8 x 20 Z.Bianca	Screw DIN 931 PG CI 8.8 M 10 x 40 Z. white
BV88	BV008800	NR	Vite TCEI PG DIN 912 CI 10.9 M 10 x 18 Z.Bianca	Screw DIN 912 PG CI 10.9 M 10 x 18 Z. white
BV89	BV008900	NR	Vite TCEI PG DIN 912 CI 8.8 M 8 x 70 Z.Bianca	Screw DIN 912 PG CI 8.8 M 8 x 70 Z. white
BV91	BV009100	NR	Vite TE Tutto Filetto PG DIN 933 CI 8.8 M 6 x 40 Z.Bianca	Screw All Thread DIN 933 PG CI 8.8 M 6 x 40 Z. white
BV92	BV009200	NR	Vite TE Tutto Filetto PG DIN 933 CI 8.8 M 10 x 60 Z.Bianca	Screw All Thread DIN 933 PG CI 8.8 M 10 x 60 Z. white
BV93	BV009300	NR	Vite TSPEI PG DIN 7991 CI 10.9 M 5 x 20 Z.Bianca	screw DIN 7991 CI 10.9 M 5 x 20 Z. white
BV94	BV009400	NR	Vite TC Croce PG DIN 7985 CI 4.8 M 4 x 12 Z.Bianca	Cross head screw DIN 7985 PG CI 4.8 M 4 x 12 Z. white



POS	Codice	U.M.	 Descrizione	 Description
BV95	BV009500	NR	Vite TE Tutto Filetto PG DIN 933 CI 8.8 M 4 x 12 Z.Bianca	Screw All Thread DIN 933 PG CI 8.8 M 4 x 12 Z. white
BV96	BV009600	NR	Vite TCEI PG DIN 912 CI 12.9 M 12 x 30 Dac 320A	Screw DIN 912 CI 12.9 M 12 x 30 Dac 320A
BV97	BV009700	NR	Vite Autofil. Testa Mezza Tonda C15 4,8 x 13 Z.Bianca	Half Round Head Self Tapping Screw C15 4,8 x 13
BV98	BV009800	NR	Vite TC Croce PG DIN 7985 CI 4.8 M 4 x 12 Z.Bianca	Screw DIN 7985 CI 4.8 M 4 x 12
BV99	BV009900	NR	Vite TE Parziale Filetto PG DIN 931 CI 8.8 M 5 x 65 Z.Bianca	Screw Partial Thread DIN 931 PG CI 8.8 M 5 x 65 Z. white
BV100	BV010000	NR	Vite Autofil. Testa Mezza Tonda C15 4,8 x 16 Z.Bianca	Half Round Head Self Tapping Screw C15 4,8 x 16
BV101	BV010100	NR	Vite TSPEI PG DIN 7991 CI 10.9 M 8 x 25 Z.Bianca	screw DIN 7991 CI 10.9 M 8 x 25 Z. white
BV102	BV010200	NR	Vite TCEI PG DIN 912 CI 8.8 M 4 x 30 Z.Bianca	Screw DIN 912 PG CI 8.8 M 4 x 30 White Z
BV103	BV010300	NR	Vite TSPEI PG DIN 7991 CI 10.9 M 5 x 16 Z.Bianca	Screw DIN 7991 CI 10.9 M 5 x 16 Z. white
BV104	BV010400	NR	Vite TCEI bassa PG DIN 7984 CI 10.9 M 12 x 18 Z.D.Bianca	Screw DIN 7984 low PG CI 10.9 M 12 x 18 Z. D. white
BV105	BV010500	NR	Vite TE Parziale Filetto PG DIN 931 CI 8.8 M 12 x 75 Z.Bianca	Screw Partial Thread DIN 931 PG CI 8.8 M 12 x 75 Z. white
BV106	BV010600	NR	Vite TE Tutto Filetto PG DIN 933 CI 8.8 M 8 x 22 Z.Bianca	Screw All Thread DIN 933 PG CI 8.8 M 8 x 22 Z. white
BV107	BV010700	NR	Vite TE Tutto Filetto PG DIN 933 CI 8.8 M 6 x 35 Z.Bianca	Screw All Thread DIN 933 PG CI 8.8 M 6 x 35 Z. white
BV108	BV010800	NR	Vite TE Parziale Filetto PG DIN 931 CI 8.8 M 4 x 45 Z.Bianca	Screw Partial Thread DIN 931 PG CI 8.8 M 4 x 45 Z. white
BV109	BV010900	NR	Vite TE Tutto Filetto PG DIN 933 CI 10.9 M 16 x 45 Z.D.Bianca	Screw All Thread DIN 933 PG CI 10.9 M 16 x 45 ZD white
BV110	BV011000	NR	Vite TE Parziale Filetto PG DIN 931 CI 10.9 M 16 x 100 Z.D.Bianca	Screw Partial Thread DIN 931 PG CI 10.9 M 16 x 100 ZD white
BV111	BV011100	NR	Vite TE Parziale Filetto PG DIN 931 CI 10.9 M 16 x 105 Z.D.Bianca	Screw Partial Thread DIN 931 PG CI 10.9 M 16 x 105 ZD white



POS	Codice	U.M.	 Descrizione	 Description
BV112	BV011200	NR	Vite TE Tutto Filetto PG DIN 933 CI 8.8 M 10 x 25 Z.Bianca	Screw All Thread DIN 933 PG CI 8.8 M 10 x 25 Z. white
BV113	BV011300	NR	Vite TSPEI PG DIN 7991 CI 10.9 M 6 x 50 Z.Bianca	TSPEI PG screw DIN 7991 CI 10.9 M 6 x 50 Z. white
BV114	BV011400	NR	Vite TSPEI PG DIN 7991 CI 10.9 M 8 x 25 Z.Bianca	TSPEI PG screw DIN 7991 CI 10.9 M 8 x 25 Z. white
BV115	BV011500	NR	Vite TE Tutto Filetto PG DIN 933 CI 8.8 M 10 x 45 Z.Bianca	Screw All Thread DIN 933 PG CI 8.8 M 10 x 45 Z. white
BV116	BV011600	NR	Vite TE Tutto Filetto PG DIN 933 CI 8.8 M 5 x 8 Z.Bianca	Screw All Thread DIN 933 PG CI 8.8 M 5 x 8 Z. white
BV117	BV011700	NR	Vite TE Tutto Filetto PG DIN 933 CI 8.8 M 8 x 18 Z.Bianca	Screw All Thread DIN 933 PG CI 8.8 M 8 x 18 Z. white
BV118	BV011800	NR	Vite TE Tutto Filetto PG DIN 933 CI 8.8 M 8 x 40 Z.Bianca	Screw All Thread DIN 933 PG CI 8.8 M 8 x 40 Z. white
BV119	BV011900	NR	Vite TCEI PG DIN 912 CI 8.8 M 8 x 100 Z.Bianca	Screw DIN 912 PG CI 8.8 M 8 x 100 Z. white
BV120	BV012000	NR	Vite TCEI PG DIN 912 CI 8.8 M 8 x 110 Z.Bianca	Screw DIN 912 PG CI 8.8 M 8 x 110 Z. white
BV121	BV012100	NR	Vite TE Parziale Filetto PG DIN 931 CI 8.8 M 5 x 75 Z.Bianca	Screw Partial Thread DIN 931 PG CI 8.8 M 5 x 75 Z. white
BV122	BV012200	NR	Vite TE Parziale Filetto PG DIN 931 CI 8.8 M 12 x 130 Z.Bianca	Screw Partial Thread DIN 931 PG CI 8.8 M 12 x 130 Z. white
BV123	BV012300	NR	Vite TC Croce PG DIN 7985 CI 4.8 M 4 x 8 Z.Bianca	Cross head screw DIN 7985 PG CI 4.8 M 4 x 8 Z. white
BV124	BV012400	NR	Vite TCEI PG DIN 912 CI 8.8 M 6 x 40 Z.Bianca	Screw DIN 912 PG CI 8.8 M 6 x 40 Z. white
BV125	BV012500	NR	Vite TE Tutto Filetto PG DIN 933 CI 8.8 M 4 x 20 Z.Bianca	Screw All Thread DIN 933 PG CI 8.8 M 4 x 20 Z. white
BV126	BV012600	NR	Vite TE UNC ANSI B18.2.1 GR.5 3/8 x 1" Z.Bianca	Screw UNC ANSI B18.2.1 GR.5 3/8 x 1" Z. White
BV127	BV012700	NR	Vite TE UNC ANSI B18.2.1 GR.5 3/8 x 1" 1/4Z.Bianca	Screw UNC ANSI B18.2.1 GR.5 3/8 x 1" 1/4 Z. White
BV128	BV012800	NR	Vite TE Tutto Filetto PG DIN 933 CI 8.8 M 4 x 16 Z.Bianca	Screw All Thread DIN 933 PG CI 8.8 M 4 x 16 Z. white
BV129	BV012900	NR	Vite TCEI PG DIN 912 CI 8.8 M 5 x 16 Z.Bianca	Screw DIN 912 PG CI 8.8 M 5 x 16 Z. white



POS	Codice	U.M.	 Descrizione	 Description
BV130	BV013000	NR	Vite TCEI PG DIN 912 CI 8.8 M 3 x 12 Z.Bianca	Screw DIN 912 PG CI 8.8 M 3 x 12 Z. white
BV131	BV013100	NR	Vite TSPEI PG DIN 7991 CI 10.9 M 5 x 30 Z.Bianca	TSPEI PG screw DIN 7991 CI 10.9 M 5 x 30 Z. white
BV132	BV013200	NR	Vite TSPEI PG DIN 7991 CI 10.9 M 5 x 55 Z.Bianca	TSPEI PG screw DIN 7991 CI 10.9 M 5 x 55 Z. white
BV133	BV013300	NR	Vite TE Tutto Filetto PG DIN 933 CI 8.8 M 3 x 25 Z.Bianca	Screw All Thread DIN 933 PG CI 8.8 M 3 x 25 Z. white
BV134	BV013400	NR	Vite TE Parziale Filetto PG DIN 931 CI 8.8 M 10 x 65 Z.Bianca	Screw Partial Thread DIN 931 PG CI 8.8 M 10 x 65 Z. white
BV135	BV013500	NR	Vite TCEI PG DIN 912 CI 8.8 M 12 x 50	Screw DIN 912 CI 8.8 M 12 x 50
BV136	BV013600	NR	Vite TSPEI PG DIN 7991 CI 10.9 M 5 x 25 Z.Bianca	TSPEI PG screw DIN 7991 CI 10.9 M 5 x 25 Z. white
BV137	BV013700	NR	Vite TCEI PG DIN 912 CI 8.8 M 8 x 30	Screw DIN 912 CI 8.8 M 8 x 30
BV138	BV013800	NR	Vite TC Croce PG DIN 7985 CI 4.8 M 5 x 10 Z.Bianca	Screw DIN 7985 CI 4.8 M 5 x 10
BV139	BV013900	NR	Vite TCEI PG DIN 912 CI 12.9 M 4 x 25 Z. Bianca	Screw DIN 912 CI 12.9 M 4 x 25 Z. Withe
BV140	BV014000	NR	Vite TE Parziale Filetto PG DIN 931 CI 8.8 M 5 x 70 Z.Bianca	Screw Partial Thread DIN 931 PG CI 8.8 M 5 x 70 Z. white
BV141	BV014100	NR	Vite TE Parziale Filetto PG DIN 931 CI 8.8 M 12 x 90 Z.Bianca	Screw Partial Thread DIN 931 PG CI 8.8 M 12 x 90 Z. white
BV142	BV014200	NR	Vite TE Parziale Filetto PG DIN 931 CI 8.8 M 8 x 55 Z.Bianca	Screw Partial Thread DIN 931 PG CI 8.8 M 8 x 55 Z. white
BV143	BV014300	NR	Vite TSPEI PG DIN 7991 CI 10.9 M 10 x 20 Z.Bianca	TSPEI PG screw DIN 7991 CI 10.9 M 10 x 20 Z. white
BV144	BV014400	NR	Vite TE Tutto Filetto PG DIN 933 CI 8.8 M 12 x 20 Z.Bianca	Screw All Thread DIN 933 PG CI 8.8 M 12 x 20 Z. white
BV145	BV014500	NR	Vite TE Tutto Filetto PG DIN 933 CI 8.8 M 12 x 35 Z.Bianca	Screw All Thread DIN 933 PG CI 8.8 M 12 x 35 Z. white
BV146	BV014600	NR	Vite TE Tutto Filetto PF DIN 961 CI 8.8 M 10 x 1,25 x 25 Z.Bianca	All PF thread hex head screw DIN 961 CI 8.8 M 10 x 1,25 x 25 Z.Bianca



POS	Codice	U.M.	 Descrizione	 Description
BV147	BV014700	NR	Vite TSPEI PG DIN 7991 CI 10.9 M 12 x 90 Z.Bianca	TSPEI PG screw DIN 7991 CI 10.9 M12 x 90 Z. white
BV148	BV014800	NR	Vite TSPEI PG DIN 7991 CI 10.9 M 6 x 16 Z.Bianca	TSPEI PG screw DIN 7991 CI 10.9 M6 x 16 Z. white
BV149	BV014900	NR	Vite TBEI PG ISO 7380 CI 10.9 M 6 x 20 Z.Bianca	Hex socket screw ISO 7380 PG CI 10.9 M 6 x 20 Z. white
BV150	BV015000	NR	Vite TE Tutto Filetto PG DIN 933 CI 10.9 M 14 x 40 Z.Bianca	Screw All Thread DIN 933 PG CI 10.9 M 14 x 40 Z. white
BV151	BV015100	NR	Vite TE Parziale Filetto PG DIN 931 CI 8.8 M 10 x 85 Z.Bianca	Screw Partial Thread DIN 931 PG CI 8.8 M 10 x 85 Z. white
BV152	BV015200	NR	Vite TE Parziale Filetto PG DIN 931 CI 8.8 M 10 x 75 Z.Bianca	Screw Partial Thread DIN 931 PG CI 8.8 M 10 x 75 Z. white
BV153	BV015300	NR	Vite TE Tutto Filetto PG DIN 933 CI 8.8 M14 x 45 Z.Bianca	Screw All Thread DIN 933 PG CI 8.8 M14 x 45 Z. white
BV154	BV015400	NR	Vite TCEI PG DIN 912 CI 12.9 M 8 x 35 GEOMET 321A	Screw DIN 912 CI 12.9 M 8 x 35 GEOMET 321A
BV155	BV015500	NR	Vite TCEI PG DIN 912 CI 12.9 M 5 x 20 GEOMET 321A	Screw DIN 912 CI 12.9 M 5 x 20 GEOMET 321A
BV156	BV015600	NR	Vite TBEI PG ISO 7380 CI 10.9 M 6 x 25 Z.Bianca	Hex socket screw ISO 7380 PG CI 10.9 M 6 x 25 Z. white
BV157	BV015700	NR	Vite TBEI PG ISO 7380 CI 10.9 M 8 x 20 Z.Bianca	Hex socket screw ISO 7380 PG CI 10.9 M 8 x 20 Z. white
BV158	BV015800	NR	Vite TBEI PG ISO 7380 CI 10.9 M 6 x 70 Z.Bianca	Hex socket screw ISO 7380 PG CI 10.9 M 6 x 70 Z. white
BV159	BV015900	NR	Vite TBEI PG ISO 7380 CI 10.9 M 10 x 20 Z.Bianca	Hex socket screw ISO 7380 PG CI 10.9 M 10 x 20 Z. white
BV160	BV016000	NR	Vite TSPEI PG DIN 7991 CI 10.9 M 4 x 16 Z.Bianca	TSPEI PG screw DIN 7991 CI 10.9 M4 x 16 Z. white
BV161	BV016100	NR	Vite TE UNC ANSI B18.2.1 GR.5 1/2 passo 13 L= 1" 1/4	UNC hex head screw ANSI B18.2.1 GR.5 1/2 11 L = 1 "1/4
BV162	BV016200	NR	Vite TCEI PG DIN 912 CI 12.9 M14 x 45 GEOMET 321A	Screw DIN 912 CI 12.9 M14 x 45 GEOMET 321A
BV163	BV016300	NR	Vite TCEI PG DIN 912 CI 8.8 M6 x 35 GEOMET 321A	Screw DIN 912 CI 8.8 M6 x 35 GEOMET 321A

POS	Codice	U.M.	 Descrizione	 Description
BV164	BV016400	NR	Vite TCEI PG DIN 912 CI 8.8 M10 x 35 GEOMET 321A	Screw DIN 912 CI 8.8 M10 x 35 GEOMET 321A
BV165	BV016500	NR	Vite TE Tutto Filetto PG DIN 933 CI 8.8 M8 x 12 Z.Bianca	Screw All Thread DIN 933 PG CI 8.8 M8 x 12 Z. white
BV166	BV016600	NR	Vite TCEI PG DIN 912 CI 8.8 M4 x 20 GEOMET 321A	Screw DIN 912 CI 8.8 M4 x 20 GEOMET 321A
BV167	BV016700	NR	Vite TCEI PG DIN 912 CI 8.8 M4 x 20 GEOMET 321A	All PF thread hex head screw DIN 961 CI 8.8 M 12 x 1,25 x 30 Z.Bianca
BV168	BV016800	NR	Vite TE Tutto Filetto PF DIN 961 CI 8.8 M 10 x 1,25 x 30 Z.Bianca	All PF thread hex head screw DIN 961 CI 8.8 M 10 x 1,25 x 30 Z.Bianca
BV169	BV016900	NR	Vite TCEI PG DIN 912 CI 8.8 M 10 x 1,25 x 30	Screw DIN 912 CI 8.8 M10 x 1,25 x 30
BV170	BV017000	NR	Vite TE Tutto Filetto PF DIN 961 CI 8.8 M 10 x 1,25 x 30 Z.Bianca	All PF thread hex head screw DIN 961 CI 8.8 M 10 x 1,25 x 60 Z.Bianca
BV171	BV017100	NR	Vite TE Tutto Filetto PF DIN 961 CI 8.8 M 12 x 1,25 x 25 Z.Bianca	All PF thread hex head screw DIN 961 CI 8.8 M 12 x 1,25 x 25 Z.Bianca
BV172	BV017200	NR	Vite TE UNC ANSI B18.2.1 GR.5 5/8 passo 11 L= 1" 1/2	UNC hex head screw ANSI B18.2.1 GR.5 5/8 11 L = 1 "1/2
BV173	BV017300	NR	Vite TE Tutto Filetto PG DIN 933 CI 8.8 M12 x 30 Z.Bianca	Screw All Thread DIN 933 PG CI 8.8 M12 x 30 Z. white
BV174	BV017400	NR	Vite TE Tutto Filetto PG DIN 933 CI 8.8 M5 x 45 Z.Bianca	Screw All Thread DIN 933 PG CI 8.8 M5 x 45 Z. white
BV175	BV017500	NR	Vite TE Tutto Filetto PG DIN 933 CI 8.8 M12 x 80 Z.Bianca	Screw All Thread DIN 933 PG CI 8.8 M12 x 80 Z. white
BV176	BV017600	NR	Vite TCEI PG DIN 912 CI 8.8 M6 x 25 GEOMET 321A	Screw DIN 912 CI 8.8 M6 x 25 GEOMET 321A
BV177	BV017700	NR	Vite TE Tutto Filetto PG DIN 933 CI 8.8 M12 x 85 Z.Bianca	Screw All Thread DIN 933 PG CI 8.8 M12 x 85 Z. white
BV178	BV017800	NR	Vite TE Tutto Filetto PG DIN 933 CI 8.8 M8 x 90 Z.Bianca	Screw All Thread DIN 933 PG CI 8.8 M8 x 90 Z. white
BV179	BV017900	NR	Vite TE Tutto Filetto PG DIN 933 CI 8.8 M5 x 40 Z.Bianca	Screw All Thread DIN 933 PG CI 8.8 M5 x 40 Z. white
BV180	BV018000	NR	Vite TE Tutto Filetto PG DIN 933 CI 8.8 M6 x 75 Z.Bianca	Screw All Thread DIN 933 PG CI 8.8 M6 x 75 Z. white

POS	Codice	U.M.	 Descrizione	 Description
BV181	BV018100	NR	Vite TE Tutto Filetto PG DIN 933 CI 8.8 M10 x 40 Z.Bianca	Screw All Thread DIN 933 PG CI 8.8 M10 x 40 Z. white
BV182	BV018200	NR	Vite TE Tutto Filetto PG DIN 933 CI 10.9 M 16 x 70 Z.Bianca	Screw All Thread DIN 933 PG CI 10.9 M 16 x 70 Z. white
BV183	BV018300	NR	Vite TE Tutto Filetto PG DIN 933 CI 8.8 M5 x 10 Z.Bianca	Screw All Thread DIN 933 PG CI 8.8 M5 x 10 Z. white
BV184	BV018400	NR	Vite TE Tutto Filetto PG DIN 933 CI 8.8 M10 x 16 Z.Bianca	Screw All Thread DIN 933 PG CI 8.8 M10 x 16 Z. white
BV185	BV018500	NR	Vite TCEI PG DIN 912 CI 8.8 M8 x 55 GEOMET 321A	Screw DIN 912 CI 8.8 M8 x 55 GEOMET 321A
BV186	BV018600	NR	Vite TCEI PG DIN 912 CI 12.9 M10 x 30 GEOMET 321A	Screw DIN 912 CI 12.9 M10 x 30 GEOMET 321A
BV187	BV018700	NR	Vite TCEI PG DIN 912 CI 12.9 M14 x 40 GEOMET 321A	Screw DIN 912 CI 12.9 M14 x 40 GEOMET 321A
BV188	BV018800	NR	Vite TE Tutto Filetto PG DIN 933 CI 8.8 M 12 x 60 Z.Bianca	Screw All Thread DIN 933 PG CI 8.8 M12 x 60 Z. white
BV189	BV018900	NR	Vite TE Tutto Filetto PG DIN 933 CI 8.8 M 12 x 55 Z.Bianca	Screw All Thread DIN 933 PG CI 8.8 M12 x 55 Z. white
BV190	BV019000	NR	Vite TE Tutto Filetto PG DIN 933 CI 8.8 M 12 x 50 Z.Bianca	Screw All Thread DIN 933 PG CI 8.8 M12 x 50 Z. white
BV191	BV019100	NR	Vite TE Tutto Filetto PG DIN 933 CI 8.8 M 16 x 50 Z.Bianca	Screw All Thread DIN 933 PG CI 8.8 M16 x 50 Z. white
BV192	BV019200	NR	Vite TE Tutto Filetto PG DIN 933 CI 8.8 M 16 x 55 Z.Bianca	Screw All Thread DIN 933 PG CI 8.8 M16 x 55 Z. white
BV193	BV019300	NR	Vite TE Parziale Filetto PG DIN 931 CI 8.8 M 10 x 55 Z.Bianca	Screw Partial Thread DIN 931 PG CI 8.8 M 10 x 55 Z. white
BV194	BV019400	NR	Vite TE Parziale Filetto PG DIN 931 CI 8.8 M 16 x 230 Z.Bianca	Screw Partial Thread DIN 931 PG CI 8.8 M 16 x 230 Z. white
BV195	BV019500	NR	Vite TE Parziale Filetto PG DIN 931 CI 8.8 M 6 x 50 Z.Bianca	Screw Partial Thread DIN 931 PG CI 8.8 M 6 x 50 Z. white
BV196	BV019600	NR	Vite TE Parziale Filetto PG DIN 931 CI 8.8 M 6 x 65 Z.Bianca	Screw Partial Thread DIN 931 PG CI 8.8 M 6 x 65 Z. white
BV197	BV019700	NR	Vite TE Parziale Filetto PG DIN 931 CI 8.8 M 8 x 45 Z.Bianca	Screw Partial Thread DIN 931 PG CI 8.8 M 8 x 45 Z. white



POS	Codice	U.M.	 Descrizione	 Description
BV198	BV019800	NR	Vite TE Parziale Filetto PG DIN 931 CI 8.8 M 8 x 55 Z.Bianca	Screw Partial Thread DIN 931 PG CI 8.8 M 8 x 55 Z. white
BV199	BV019900	NR	Vite TE Parziale Filetto PG DIN 931 CI 8.8 M 8 x 60 Z.Bianca	Screw Partial Thread DIN 931 PG CI 8.8 M 8 x 60 Z. white
BV200	BV020000	NR	Vite TE Tutto Filetto PG DIN 933 CI 10.9 M 16 x 40 Z.Bianca	Screw All Thread DIN 933 PG CI 10.9 M 16 x 40 Z. white
BV201	BV020100	NR	Vite TSPEI PG DIN 7991 CI 10.9 M16 x 45 Z.Bianca	TSPEI PG screw DIN 7991 CI 10.9 M16 x 45 Z. white
BV202	BV020200	NR	Vite TCEI PG DIN 912 CI 12.9 M3 x 12 ZINC. iridescente Fe/Zn5IVs	Screw DIN 912 CI 12.9 M3 x 12 ZINC. iridescente Fe/Zn5IVs
BV203	BV020300	NR	Vite TC Croce PG DIN 7985 CI 4.8 M M 3 x 5 Z.Bianca	Screw DIN 7985 CI 4.8 M M 3 x 5
BV204	BV020400	NR	Vite TC Croce PG DIN 7985 CI 4.8 M M 3 x 8 Z.Bianca	Screw DIN 7985 CI 4.8 M M 3 x 8
BV205	BV020500	NR	Vite TTQST DIN 603/555 CI 4.8 M 8 x 35 Z.Bianca	TTQST Screw DIN 603/555 CL 4.8 M 8 x 35 Z. White
BV206	BV020600	NR	Vite TC Croce PG DIN 7985 CI 4.8 M M 5 x 80 Z.Bianca	Screw DIN 7985 CI 4.8 M M 5 x 80
BV207	BV020700	NR	Vite TE Parziale Filetto PG DIN 931 CI 8.8 M 10 x 80 Z.Bianca	Screw Partial Thread DIN 931 PG CI 8.8 M 10 x 80 Z. white
BV208	BV020800	NR	Vite TE Tutto Filetto PG DIN 933 CI 8.8 M 16 x 35 Z.D.Bianca	Screw All Thread DIN 933 PG CI 8.8 M 16 x 35 ZD white
BV209	BV020900	NR	Vite TE Parziale Filetto PG DIN 931 CI 8.8 M 10 x 95 Z.Bianca	Screw Partial Thread DIN 931 PG CI 8.8 M 10 x 95 Z. white
BV210	BV021000	NR	Vite TE Tutto Filetto PG DIN 933 CI 8.8 M 6 x 14 Z.D.Bianca	Screw All Thread DIN 933 PG CI 8.8 M 6 x 14 ZD white
BV211	BV021100	NR	Vite TE Tutto Filetto PG DIN 933 CI 8.8 M 12 x 25 Z.D.Bianca	Screw All Thread DIN 933 PG CI 8.8 M 12 x 25 ZD white
BV212	BV021200	NR	Vite TE Tutto Filetto PG DIN 933 CI 8.8 M 4 x 14 Z.D.Bianca	Screw All Thread DIN 933 PG CI 8.8 M 4 x 14 ZD white
BV213	BV021300	NR	Vite TE Tutto Filetto PG DIN 933 CI 8.8 M 16 x 60 Z.D.Bianca	Screw All Thread DIN 933 PG CI 8.8 M 16 x 60 ZD white
BV214	BV021400	NR	Vite TE Parziale Filetto PG DIN 931 CI 8.8 M 6 x 100 Z.Bianca	Screw Partial Thread DIN 931 PG CI 8.8 M 6 x 100 Z. white



POS	Codice	U.M.	 Descrizione	 Description
BV215	BV021500	NR	Vite TE Parziale Filetto PG DIN 931 CI 10.9 M 16 x 110 Z.D.Bianca	Screw Partial Thread DIN 931 PG CI 10.9 M 16 x 110 ZD white
BV216	BV021600	NR	Vite TE Parziale Filetto PG DIN 931 CI 10.9 M 16 x 240 Z.D.Bianca	Screw Partial Thread DIN 931 PG CI 10.9 M 16 x 240 ZD white
BV217	BV021700	NR	Vite TSPEI PG DIN 7991 CI 10.9 M 8 x 30 Z.Bianca	TSPEI PG screw DIN 7991 CI 10.9 M8 x 30 Z. white
BV218	BV021800	NR	Vite TSPEI PG DIN 7991 CI 10.9 M 5 x 6 Z.Bianca	TSPEI PG screw DIN 7991 CI 10.9 M5 x 6 Z. white
BV219	BV021900	NR	Vite TSPEI PG DIN 7991 CI 10.9 M 5 x 70 Z.Bianca	TSPEI PG screw DIN 7991 CI 10.9 M5 x 70 Z. white
BV220	BV022000	NR	Vite TSPEI PG DIN 7991 CI 10.9 M 12 x 35 Z.Bianca	TSPEI PG screw DIN 7991 CI 10.9 M12 x 35 Z. white
BV221	BV022100	NR	Vite TCEI PG DIN 912 CI 12.9 M10 x 20 GEOMET 321A	Screw DIN 912 CI 12.9 M10 x 20 GEOMET 321A
BV222	BV022200	NR	Vite TCEI PG DIN 912 CI 12.9 M8 x 90 GEOMET 321A	Screw DIN 912 CI 12.9 M8 x 90 GEOMET 321A
BV223	BV022300	NR	Vite TCEI PG DIN 912 CI 12.9 M3 x 5 ZINC.	Screw DIN 912 CI 12.9 M3 x 5 ZINC.
BV224	BV022400	NR	Vite TBEI PG ISO 7380 CI 10.9 M 8 x 22 Z.Bianca	Hex socket screw ISO 7380 PG CI 10.9 M 8 x 22 Z. white
BV225	BV022500	NR	Vite TE Parziale Filetto PG DIN 931 CI 8.8 M 10 x 100 Z.Bianca	Screw Partial Thread DIN 931 PG CI 8.8 M 10 x 100 Z. white
BV226	BV022600	NR	Vite TE Parziale Filetto PG DIN 931 CI 8.8 M 10 x 110 Z.Bianca	Screw Partial Thread DIN 931 PG CI 8.8 M 10 x 110 Z. white
BV227	BV022700	NR	Vite TE Tutto Filetto PG DIN 933 CI 10.9 M 12 x 45 Z.D.Bianca	Screw All Thread DIN 933 PG CI 10.9 M 12 x 45 ZD white
BV228	BV022800	NR	Vite TE Tutto Filetto PG DIN 933 CI 10.9 M 14 x 35 Z.D.Bianca	Screw All Thread DIN 933 PG CI 10.9 M 14 x 35 ZD white
BV229	BV022900	NR	Vite TSPEI PG DIN 7991 CI 10.9 M 12 x 30 Z.Bianca	TSPEI PG screw DIN 7991 CI 10.9 M12 x 30 Z. white
BV230	BV023000	NR	Vite TE flangiata Tutto Filetto PG DIN 6921 CI 8.8 M 5 x 12 Zinconickel nero +sigillante	Flange Screw All Thread DIN 6921 PG CI 8.8 M 5 x 12 Zincnickel black +sealant

POS	Codice	U.M.	 Descrizione	 Description
BV231	BV023100	NR	Vite TE flangiata Tutto Filetto PG DIN 6921 CI 8.8 M 6 x 16 Zinconickel nero +sigillante	Flange Screw All Thread DIN 6921 PG CI 8.8 M 6 x 16 Zincnickel black +sealant
BV232	BV023200	NR	Vite TE Tutto Filetto PG DIN 933 CI 8.8 M 5 x 25 Z.D.Bianca	Screw All Thread DIN 933 PG CI 8.8 M 5 x 25 ZD white
BV233	BV023300	NR	Vite TE Tutto Filetto PG DIN 933 CI 8.8 M 8 x 130 Z.D.Bianca	Screw All Thread DIN 933 PG CI 8.8 M 8 x 130 ZD white
BV234	BV023400	NR	Vite TBEI PG ISO 7380 CI 10.9 M 8 x 22 Z.Bianca	Hex socket screw ISO 7380 PG CI 10.9 M 8 x 22 Z. white
BV235	BV023500	NR	Vite TE Tutto Filetto PG DIN 933 CI 10.9 M 16 x 35 Z.D.Bianca	Screw All Thread DIN 933 PG CI 10.9 M 16 x 35 ZD white
BV236	BV023600	NR	Vite TE Parziale Filetto PG DIN 931 CI 8.8 M 6 x 45 Z.Bianca	Screw Partial Thread DIN 931 PG CI 8.8 M 6 x 45 Z. white
BV237	BV023700	NR	Vite TE Tutto Filetto PG DIN 933 CI 10.9 M 12 x 30 Z.D.Bianca	Screw All Thread DIN 933 PG CI 10.9 M 12 x 30 ZD white



POS	Codice	U.M.	 Descrizione	 Description
RB1	RB000100	NR	DADO PER OGIVA Ø=12	NUT FOR OGIVA Ø = 12
RD1	RD000100	NR	RACCORDO CORPO A "T" EO F(DKOL)-M-M 8L	FITTING BODY A "T" EO F (DKOL) M-M-8L
RD2	RD000200	NR	RACCORDO CORPO A "T" EO F(DKOL)-M-M 10L	FITTING BODY A "T" EO F (DKOL) M-M-10L
RD3	RD000300	NR	RACCORDO CORPO A "T" EO F(DKOL)-M-M 12L	FITTING BODY A "T" EO F (DKOL) M-M-12L
RD4	RD000400	NR	RACCORDO CORPO A "T" EO F(DKOL)-M-M 15L	FITTING BODY A "T" EO F (DKOL) M-M-15L
RD5	RD000500	NR	RACCORDO CORPO A "T" EO M-F(DKOL)-M 10L	FITTING BODY A "T" EO M-F (DKOL) M-10L
RD6	RD000600	NR	RACCORDO CORPO A "T" EO M-F(DKOL)-M 12L	FITTING BODY A "T" EO M-F (DKOL) M-12L
RD7	RD000700	NR	RACCORDO CORPO A "T" EO 8L M 14*1.5	FITTING BODY A "T" EO 8L M 14 * 1.5
RD8	RD000800	NR	RACCORDO CORPO A "T" EO 10L M 16*1.5	FITTING BODY A "T" M 10L EO 16 * 1.5
RD9	RD000900	NR	RACCORDO CORPO A "T" EO 28L M 36*2	FITTING BODY A "T" M 28L EO 36 * 2
RD10	RD001000	NR	RACCORDO CORPO A "T" EO 28L M 36*2	FITTING BODY A "T" EO M-F (DKOL) M-10L
RD11	RD001100	NR	RACCORDO CORPO A "T" EO M-F(DKOL)-M 10L	FITTING BODY A "T" EO M-F (DKOL) M-10L
RG1	RG000100	NR	RACCORDO CORPO A GOMITO 10L MASCH.-FEMM. DKOL	ELBOW FITTING BODY 10L Masch.-FEMM. DKOL
RG2	RG000200	NR	RACCORDO CORPO A GOMITO 12L MASCH.-FEMM. DKOL	ELBOW FITTING BODY 12L Masch.-FEMM. DKOL
RG3	RG000300	NR	RACCORDO CORPO A GOMITO 20S MASCHIO-FEMMINA DKOS	20S BODY FITTING ELBOW MALE-FEMALE DKOS
RG4	RG000400	NR	RACCORDO CORPO A GOMITO 28L MASCHIO-FEMMINA DKOL	28L BODY FITTING ELBOW MALE-FEMALE DKOL
RG5	RG000500	NR	RACCORDO A L MASCHIO-FEMMINA 1/8	BODY 90 ° M / F 1/8 "



POS	Codice	U.M.	 Descrizione	 Description
RN1	RN000100	NR	RACCORDO CORPO D'ESTREMITA' TENUTA ED 8L * 3/8 GAS *K*	END FITTING WITH SEAL ED 8L * 3/8 GAS * K *
RN2	RN000200	NR	RACCORDO CORPO D'ESTREMITA' TENUTA ED 12L * 3/8 GAS *K*	END FITTING WITH SEAL ED 12L * 3/8 GAS * K *
RN3	RN000300	NR	RACCORDO CORPO D'ESTREMITA' TENUTA ED 10L * 3/8 GAS *K*	FITTING END OF BODY 'AND SEAL 10L * 3/8 GAS * K *
RN4	RN000400	NR	RACCORDO CORPO D'ESTREMITA' TENUTA ED 8L * 1/4 GAS *K*	END FITTING WITH SEAL ED 8L * 1/4 GAS * K *
RN5	RN000500	NR	RACCORDO CORPO D'ESTREMITA' TENUTA ED 10L * 1/4 GAS *K*	FITTING END OF BODY 'AND SEAL 10L * 1/4 GAS * K *
RN6	RN000600	NR	RACCORDO CORPO D'ESTREMITA' TENUTA ED 12L * 1/4 GAS	FITTING END OF BODY 'AND SEAL 12L * 1/4 GAS
RN7	RN000700	NR	RACCORDO NIPLES GAS CON.- GAS CON. 1/4" * 1/4"	FITTING
RN8	RN000800	NR	RACCORDO CORPO D'ESTREMITA' TENUTA ED 15L * 1/2 GAS *K*	END FITTING WITH SEAL ED 15L * 1/2 * K * GAS
RN9	RN000900	NR	RACCORDO CORPO D'ESTREMITA' TENUTA ED 10L * 1/2 GAS *K*	FITTING END OF BODY 'AND SEAL 10L * 1/2 * K * GAS
RN10	RN001000	NR	RACCORDO CORPO D'ESTREMITA' TENUTA ED 15L * 3/4 GAS *K*	END FITTING WITH SEAL ED 15L * 3/4 GAS * K *
RN11	RN001100	NR	RACCORDO CORPO D'ESTREMITA' TENUTA ED 12L * 1/2 GAS *K*	END FITTING WITH SEAL ED 12L * 1/2 GAS * K *
RN12	RN001200	NR	RACCORDO CORPO D'ESTR. TENUTA ED 8L * 1/2 GAS	END FITTING WITH SEAL ED 8L * 1/2 GAS
RN13	RN001300	NR	RACCORDO CORPO D'ESTR. TENUTA ED 8L * 3/4 GAS	CONNECTOR BODY OF EXTR. SEAL AND 8L * 3/4 GAS
RN14	RN001400	NR	RACCORDO CORPO D'ESTR. TENUTA ED 12L * 3/4 GAS	CONNECTOR BODY OF EXTR. SEAL AND 12L * 3/4 GAS
RN15	RN001500	NR	RACCORDO CORPO D'ESTR. TENUTA ED 15L * 3/8 GAS	END FITTING WITH SEAL ED 15L * 3/8 GAS
RN16	RN001600	NR	RACCORDO CORPO D'ESTR. TENUTA ED 22L * 3/4 GAS	END FITTING WITH SEAL ED 22L * 3/4 GAS

POS	Codice	U.M.	 Descrizione	 Description
RN17	RN001700	NR	RACCORDO CORPO D'ESTR. TENUTA ED 28L * 3/4" GAS	END FITTING WITH SEAL ED 28L * 3/4 BSP
RN18	RN001800	NR	RACCORDO CORPO D'ESTR. TENUTA ED 20S * 3/4 GAS	CONNECTOR BODY OF EXTR. SEAL AND 20S * 3/4 GAS
RN19	RN001900	NR	RACCORDO CORPO D'ESTREMITA' 8L * M 12X1.5 ED	END FITTING 8L * M 12x1.5 ED
RN20	RN002000	NR	RACCORDO CORPO D'ESTREMITA' 8L * M 14X1.5 ED	FITTING END OF BODY 'AND 8L * M 14x1.5
RN21	RN002100	NR	RACCORDO CORPO D'ESTREMITA' 10L * M 18X1.5 ED	END FITTING 10L * M 18x1.5
RN22	RN002200	NR	RACCORDO CORPO D'ESTR. TENUTA ED 15L * M 18X1.5	CONNECTOR BODY OF EXTR. SEAL AND 15L * M 18x1.5
RN23	RN002300	NR	RACCORDO CORPO D'ESTR. TENUTA ED 15L * M 22X1.5	END FITTING WIHT SEAL ED 15L * M 22x1.5
RN24	RN002400	NR	RACCORDO CORPO D'ESTR. TENUTA ED 22L * M26X1.5	CONNECTOR BODY OF EXTR. SEAL AND 22L * M26x1.5
RN25	RN002500	NR	RACCORDO CORPO D'ESTR. TENUTA ED 20S * M27X2	CONNECTOR BODY OF EXTR. SEAL AND 20S * M27X2
RN26	RN002600	NR	RACCORDO CORPO D'ESTR. 8L * 9/16-18 UNF-2A	END FITTING 8L * 9/16-18 UNF-2A
RN27	RN002700	NR	RACCORDO CORPO D'ESTR. 12L * 3/4 -16 UNF-2A	END FITTING 12L * 3/4 -16 UNF-2A
RN28	RN002800	NR	RACCORDO CORPO D'ESTR. 20S * 1.5/16 -12 UN-2A	END FITTING 20S * 1.5/16 -12 UN-2A
RN29	RN002900	NR	RACCORDO CORPO D'ESTR. TENUTA ED 22L * M26X1.5	END FITTING WITH SEAL ED 22L * M26x1.5
RN30	RN003000	NR	RACCORDO CORPO D'ESTR. TENUTA ED 22L * M26X1.5	END FITTING WITH SEAL ED 22L * M26x1.5
RN31	RN003100	NR	RACCORDO CORPO D'ESTREMITA' TENUTA ED 6L * 1/4 GAS *K*	END FITTING WITH SEAL 1/4 BSPP 6L
RN32	RN003200	NR	RACCORDO CORPO D'ESTREMITA' TENUTA ED 8L * 3/8 GAS *K*	END FITTING WITH SEAL ED 8L * 3/8 GAS * K *
RO1	RO000100	NR	OGIVA PER TUBO Ø=12	OGIVE FOR TUBE Ø = 12

POS	Codice	U.M.	 Descrizione	 Description
RR1	RR000100	NR	RONDELLA RAME 1/4	COPPER WASHER 1/4
RR2	RR000200	NR	RONDELLA BONDED GAS 3/8" *K*	BONDED WASHER GAS 3/8 " * K *
RR3	RR000300	NR	RONDELLA BONDED METRICA 12 *K*	METRIC BONDED WASHER 12 * K *
RR4	RR000400	NR	RONDELLA BONDED GAS 1/4" *K*	BONDED WASHER GAS 1/4 " * K *
RR5	RR000500	NR	RONDELLA BONDED GAS 1/2" *K*	BONDED WASHER GAS 1/2 " * K *
RR6	RR000600	NR	RONDELLA RAME 3/8	COPPER WASHER 3/8
RR7	RR000700	NR	RONDELLA BONDED GAS 1/8" *K*	BONDED WASHER GAS 1/8 " * K *
RR8	RR000800	NR	RONDELLA BONDED GAS 1" *K*	BONDED WASHER GAS 1 " * K *
RR9	RR000900	NR	RONDELLA BONDED GAS 3/4" *K*	BONDED WASHER GAS 3/4 " * K *
RR10	RR001000	NR	RONDELLA BONDED GAS 1.1/4"	BONDED WASHER GAS 1.1 / 4 "
RR11	RR001100	NR	RONDELLA RAME 1/8	COPPER WASHER 1/8
RR12	RR001200	NR	RONDELLA RAME 1/2	COPPER WASHER 1/2
RS1	RS000100	NR	COPPIA SEMIFLANGE SAE 6000 3/4"	PAIR 6000 SAE flange halves 3/4 "
RS2	RS000200	NR	RACC.M 20S(M30x2) - ED M 1"5/16 UNF H=33	FITTING M 20S (M30x2) - ED M 1 "5/16 UNF H = 33
RS3	RS000300	NR	RIDUZIONE M-F GAS 1" * 1/2"	REDUCING GAS M-F 1 " * 1/2"
RS4	RS000400	NR	RACCORDO COLONNETTA M15L - 3/8" GAS H=50	COLUMN CONNECTION M15L - 3/8 "GAS H = 50
RS5	RS000500	NR	RACCORDO COLONNETTA M15L - 3/8" GAS H=96	COLUMN CONNECTION M15L - 3/8 "GAS H = 96
RS6	RS000600	NR	CODOLO M1/4" ED X FG 8L (M14X1.5)	FITTING M1 / 4 "X AND FG 8L (M14X1.5)

POS	Codice	U.M.	 Descrizione	 Description
RS7	RS000700	NR	RIDUZIONE M-F GAS 1" * 1/2"	REDUCING GAS M-F 1 " * 1/2"
RS8	RS000800	NR	RACCORDO CODOLO D' ESTR. FEM. DKO 12I*3/8 GAS ED	END FITTING FEM. DKO 12I*3/8 GAS ED
RT1	RT000100	NR	TAPPO MASCHIO TE GAS 3/8" SVASATO 60° *K*	SCREW EYE FOR GAS 1/2 "H = 50
RT2	RT000200	NR	TAPPO MASCHIO ESAGONO INTERNO GAS 1/4" SVASATO 60° *K*	MALE PLUG GAS INTERNAL HEX 1/4 "FLARE 60 ° * K *
RT3	RT000300	NR	TAPPO MASCHIO TE GAS 1/2" SVASATO 60° *K*	MALE PLUG TE GAS 1/2 "FLARE 60 ° * K *
RT4	RT000400	NR	TAPPO MASCHIO TE GAS 1/4" SVASATO 60° *K*	MALE PLUG TE GAS 1/4 "FLARE 60 ° * K *
RT5	RT000500	NR	TAPPO MASCHIO ESAGONO INTERNO GAS 3/8" SVASATO 60° *K*	MALE PLUG GAS INTERNAL HEX 3/8 "FLARE 60 ° * K *
RT6	RT000600	NR	TAPPO MASCHIO ESAGONO INTERNO GAS 1" SVASATO 60° *K*	MALE PLUG GAS INTERNAL HEX 1 "FLARE 60 ° * K *
RV1	RV000100	NR	VITE PER OCCHIO GAS 1/4" H=29 *K*	SCREW EYE FOR GAS 1/4 "H = 29 * K *
RV2	RV000200	NR	VITE PER OCCHIO DOPPIA GAS 3/8"	SCREW EYE DOUBLE FOR GAS 3/8 "
RV3	RV000300	NR	VITE PER OCCHIO GAS 1/2" H= 50	SCREW EYE FOR GAS 1/2 "H = 50
RV4	RV000400	NR	VITE PER OCCHIO DOPPIA GAS 1/4"	DOUBLE EYE SCREW FOR GAS 1/4"
RV5	RV000500	NR	VITE PER OCCHIO GAS 3/8"	SCREW EYE FOR GAS 3/8"





3121700



An Oshkosh Corporation Company

**Corporate Office**  
**JLG Industries, Inc.**  
**1 JLG Drive**  
**McConnellsburg, PA 17233-9533 USA**  
**☎ (717) 485-5161 (Corporate)**  
**☎ (877) 554-5438 (Customer Support)**  
**☎ (717) 485-6417**

**Visit our website for JLG Worldwide Locations.**  
**[www.jlg.com](http://www.jlg.com)**