



An Oshkosh Corporation Company

---

# ***Illustrated Parts Manual***

***Compact Crawler  
X14JH***

***Diesel 100 Machines***

***ANSI***









**31219116**







December 31, 2020 - Rev A

---



Tav.	 Indice	 Index	 Index	 Inhalt	 Indice	 Inhoud
01.01.00	CARRO CON CINGOLO IN GOMMA	UNDERCARRIAGE WITH RUBBER TRACK	CHENILLARD AVEC CHENILLES EN CAOUTCHOUC	FAHRWERK MIT GUMMIKETTE	CARRO CON ORUGA DE GOMA	ONDERSTEL MET RUBBEREN RUPSBAND
01.02.00	ALLARGAMENTO IDRAULICO	HYDRAULIC EXTENSION	ECARTEMENT HYDRAULIQUE	HYDR. SPURWEITENVERSTELLEINRICHTUNG	EXTENSION HIDRAULICA	VOOR HYDRAULISCHE VERBREDING
02.01.00	BASE TORRETTA	TURRET BASE	BASE TOURELLE	ARBEITSTURM	BASE TORRETA GIRATORIA	BASIS TORENTJE
02.01.01	SERBATOIO OLIO	OIL TANK	RÉSERVOIR D'HUILE	ÖLTANK	DEPÓSITO DE ACEITE	OLIETANK
03.01.00	PRIMO BRACCIO	FIRST ARM	PREMIER BRAS	ERSTER AUSLEGERARM	PRIMO BRAZO	EERSTE ARM
03.02.00	SECONDO BRACCIO	SECOND ARM	SECOND BRAS	ZWEITER AUSLEGERARM	SEGUNDO BRAZO	TWEEDE ARM
03.03.00	TERZO BRACCIO	THIRD ARM	TROISIÈME BRAS	DRITTER AUSLEGERARM	TERCER BRAZO	DERDE ARM
03.04.00	BRACCI-SFILO E JIB	ARMS-TELESCOPIC EXTENSION AND JIB	BRAS-SECTION TELESCOPIQUE ET FLECHETTE	ARME-TELESKOP UND SCHWENKARM	BRAZO ARTICULADO-BRAZO TELESCOPICO Y PLUMA	ARMESECTIE-EXTRA CTIE EN JIB
03.05.00	SUPPORTO CESTO	BASKET SUPPORT	PANIER CUPPORT	HALTERUNG ARBEITSKORB	SOPORTE CESTA	ONDERSTEUNEN WERKBAK
04.01.00	ACCOPPIAMENTO MOTORE - POMPA	ENGINE COUPLING - PUMP	ACCOUPLLEMENT MOTEUR- POMPE	PUMPEN / MOTOR KUPPLUNG	ACOPLAMIENTO MOTOR - BOMBA	KOPPELING MOTOR - POMP
04.02.00	MOTORE ELETTRICO	ELECTRIC MOTOR	MOTEUR ÉLECTRIQUE	E-MOTOR	MOTOR ELÉCTRICO	ELECTRICHE MOTOR
05.01.00	IMPIANTO IDRAULICO MANDATE E SCARICO	SUPPLY AND DISCHARGE HYDRAULIC SYSTEM	SYSTÈME HYDRAULIQUE REFOULEMENT ET DÉCHARGEMENT	HYDRAULIKANLAGE VORLÄUFE UND RÜCKLAUF	INSTALACIÓN HIDRÁULICA IMPULSIONES Y DESCARGA	HYDRAULISCHE INSTALLATIE UITSTROMINGEN EN ONTLADING
05.02.00	IMPIANTO IDRAULICO MANDATE E SCARICO	SUPPLY AND DISCHARGE HYDRAULIC SYSTEM	SYSTÈME HYDRAULIQUE REFOULEMENT ET DÉCHARGEMENT	HYDRAULIKANLAGE VORLÄUFE UND RÜCKLAUF	INSTALACIÓN HIDRÁULICA IMPULSIONES Y DESCARGA	HYDRAULISCHE INSTALLATIE UITSTROMINGEN EN ONTLADING

Tav.	 Indice	 Index	 Index	 Inhalt	 Indice	 Inhoud
05.02.01	IMPIANTO IDRAULICO DEVIATORE	REVERSING VALVE HYDRAULIC SYSTEM	INSTALLATION HYDRAULIQUE DEVIATEUR	HYDRAULIKKREIS DES UMSTEUERVENTILS	INSTALACIÓN HIDRÁULICA DESVIADOR	HYDRAULISCHE INSTALLATIE OMLEIDER
05.02.02	DISTRIBUTORI IDRAULICI	HYDRAULIC DISTRIBUTORS	DISTRIBUTEURS HYDRAULIQUES	HYDRAULISCHE REGELSTEUERGERÄTE	DISTRIBUIDORES HIDRÁULICOS	HYDRAULISCHE VERDELERS
05.02.03	DISTRIBUTORI IDRAULICI	HYDRAULIC DISTRIBUTORS	DISTRIBUTEURS HYDRAULIQUES	HYDRAULISCHE REGELSTEUERGERÄTE	DISTRIBUIDORES HIDRÁULICOS	HYDRAULISCHE VERDELERS
05.03.00	IMPIANTO IDRAULICO TRAZIONE	HYDRAULIC SYSTEM FOR TRACTION	SYSTÈME HYDRAULIQUE DE TRACTION	HYDRAULIKANLAGE ANTRIEB	INSTALACIÓN HIDRÁULICA TRACCIÓN	HYDRAULISCHE AANDRIJFINSTALLATIE
05.03.01	IMPIANTO IDRAULICO ALLARGAMENTO CARRO	HYDRAULIC SYSTEM UNDERCARRIAGE EXPANSION	SYSTÈME HYDRAULIQUE EXTENSION DU CHARIOT	HYDRAULIKANLAGE VERBREITERUNG WAGEN	INSTALACIÓN HIDRÁULICA ENSANCHAMIENTO CARRO	HYDRAULISCHE INSTALLATIE WAGENVERBREIDING
05.04.00	IMPIANTO IDRAULICO CILINDRI STABILIZZATORI	STABILIZERS CYLINDERS HYDRAULIC SYSTEM	INSTALLATION HYDRAULIQUE CYLINDRES STABILISATERS	ABSTÜTZUNGZYLINDER ABSTÜTZUNGSHYDRAULIKZYLINDER	INSTALACIÓN HIDRÁULICA CILINDROS ESTABILIZADORS	HYDRAULISCHE INSTALLATIE STABILIZATORCILINDERS
05.04.01	IMPIANTO IDRAULICO ROTAZIONE	ROTATION HYDRAULIC SYSTEM	SYSTÈME HYDRAULIQUE ROTATION	HYDRAULIKANLAGE KORBSCHWENKUNG	INSTALACIÓN HIDRÁULICA ROTACIÓN	HYDRAULISCHE INSTALLATIE ROTATIE
05.05.00	IMPIANTO IDRAULICO CILINDRI 1-2 BRACCI	1-2 ARMS CYLINDERS HYDRAULIC SYSTEM	SYSTÈME HYDRAULIQUE CYLINDRES 1-2 BRAS	HYDRAULIKANLAGE ZYLINDER 1-2 ARM	INSTALACIÓN HIDRÁULICA CILINDROS 1-2 BRAZOS	HYDRAULISCHE INSTALLATIE CILINDERS 1-2 ARM
05.05.01	IMPIANTO IDRAULICO CILINDRO 3 BRACCIO	3 ARM CYLINDER HYDRAULIC SYSTEM	SYSTÈME HYDRAULIQUE CYLINDRE 3 BRAS	HYDRAULIKANLAGE ZYLINDER 3 ARM	INSTALACIÓN HIDRÁULICA CILINDRO 3 BRAZO	HYDRAULISCHE INSTALLATIE CILINDER 3 ARM
05.06.00	IMPIANTO IDRAULICO SFILO	TELESCOPIC HYDRAULIC SYSTEM	TELESCOPIQUE HIDRAULIQUE	TELESKOPHYDRAULIK	INSTALACIÓN EXTENSIÓN HIDRÁULICA	EXTRACTIE HYDRAULISCHE
05.07.00	IMPIANTO JIB	JIB HYDRAULIC SYSTEM	SYSTÈME HYDRAULIQUE JIB	ZYLINDER JIB ARM	INSTALACIÓN HIDRÁULICA JIB	HYDRAULISCHE INSTALLATIE JIB









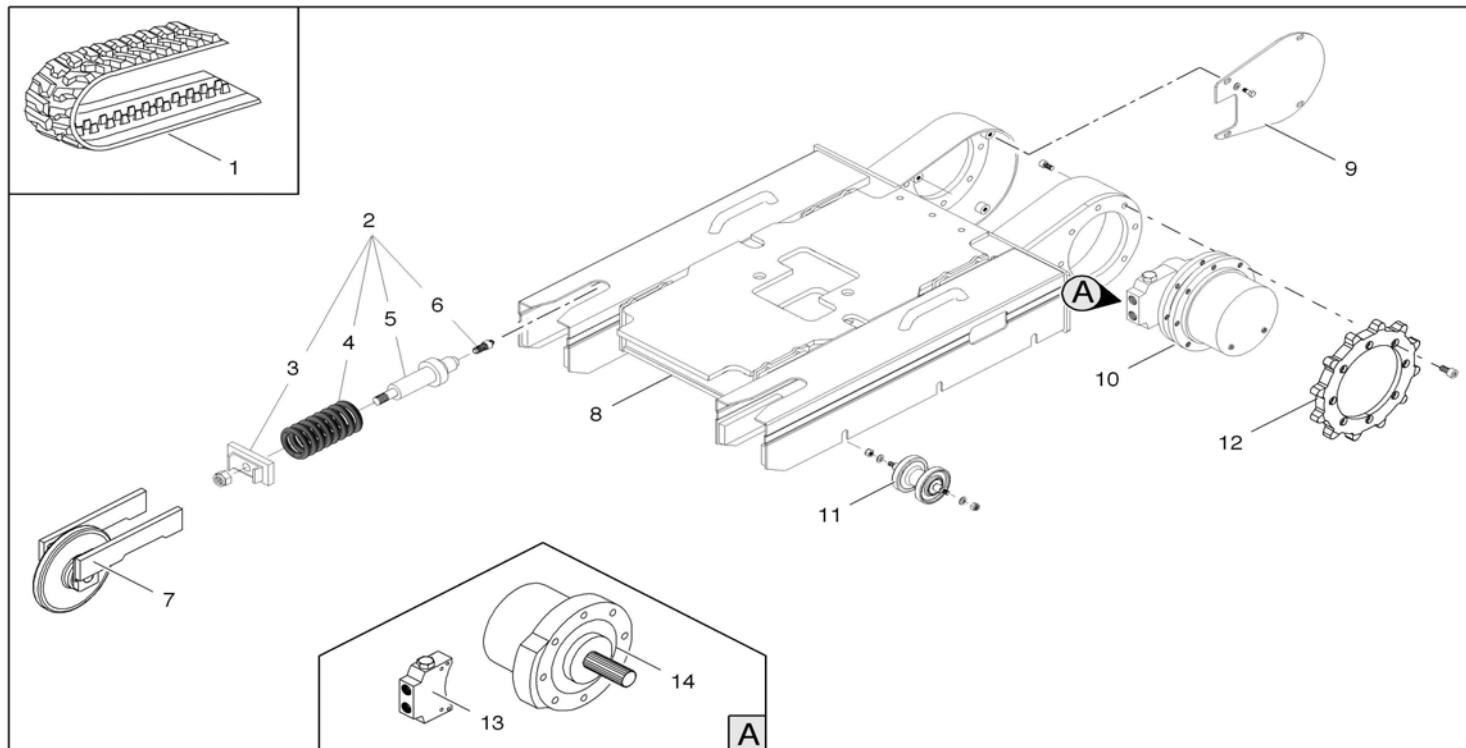



Tav.	 Indice	 Index	 Index	 Inhalt	 Indice	 Inhoud
05.08.00	IMPIANTO IDRAULICO LIVELLAMENTO	LEVELING CYLINDERS HYDRAULIC SYSTEM	SYSTÈME HYDRAULIQUE CYLINDRES BRAS	HYDRAULIKANLAGE ZYLINDER ARM	INSTALACIÓN HIDRÁULICA CILINDROS BRAZOS	HYDRAULISCHE INSTALLATIE CILINDERS ARM
05.08.01	IMPIANTO IDRAULICO ARIA COMPRESSA	COMPRESSED AIR HYDRAULIC SYSTEM	SYSTÈME HYDRAULIQUE AIR COMPRIMÉ	HYDRAULIKANLAGE DRUCKLUFT	INSTALACIÓN HIDRÁULICA AIRE COMPRIMIDO	HYDRAULISCHE INSTALLATIE PERSLUCHT
05.09.00	RICAMBI CILINDRI	CYLINDERS SPARE PARTS	RECHANGE DE CYLINDERS	ERSATZTEILE ZYLINDERKOMPENEN TEN	RECAMBIO PARA LOS CILINDROS	RESERVEONDERDELEN VAN CILINDERS
05.09.01	RICAMBI CILINDRI	CYLINDERS SPARE PARTS	RECHANGE DE CYLINDERS	ERSATZTEILE ZYLINDERKOMPENEN TEN	RECAMBIO PARA LOS CILINDROS	RESERVEONDERDELEN VAN CILINDERS
06.01.00	COMPONENTI IMPIANTO ELETTRICO	ELECTRICAL SYSTEM COMPONENTS	COMPOSANTS INSTALLATION ÉLECTRIQUE	KOMPONENTEN ELEKTROANLAGE	COMPONENTES INSTALACIÓN ELÉCTRICA	COMPONENTEN ELEKTRISCHE INSTALLATIE
06.02.00	COMPONENTI IMPIANTO ELETTRICO	ELECTRICAL SYSTEM COMPONENTS	COMPOSANTS INSTALLATION ÉLECTRIQUE	KOMPONENTEN ELEKTROANLAGE	COMPONENTES INSTALACIÓN ELÉCTRICA	COMPONENTEN ELEKTRISCHE INSTALLATIE
07.01.00	ADESIVI	STICKER	AUTOCOLLANT	AUFKLEBER	PEGATINA	ADHESIVE

X14JH/1331421 - TAV. N° 01.01.00

 **CARRO CON CINGOLO IN GOMMA**  
 **CHENILLARD AVEC CHENILLES EN CAOUTCHOUC**  
 **CARRO CON ORUGA DE GOMA**

**UNDERCARRIAGE WITH RUBBER TRACK**   
**FAHRWERK MIT GUMMIKETTE**   
**ONDERSTEL MET RUBBEREN RUPS BAND** 









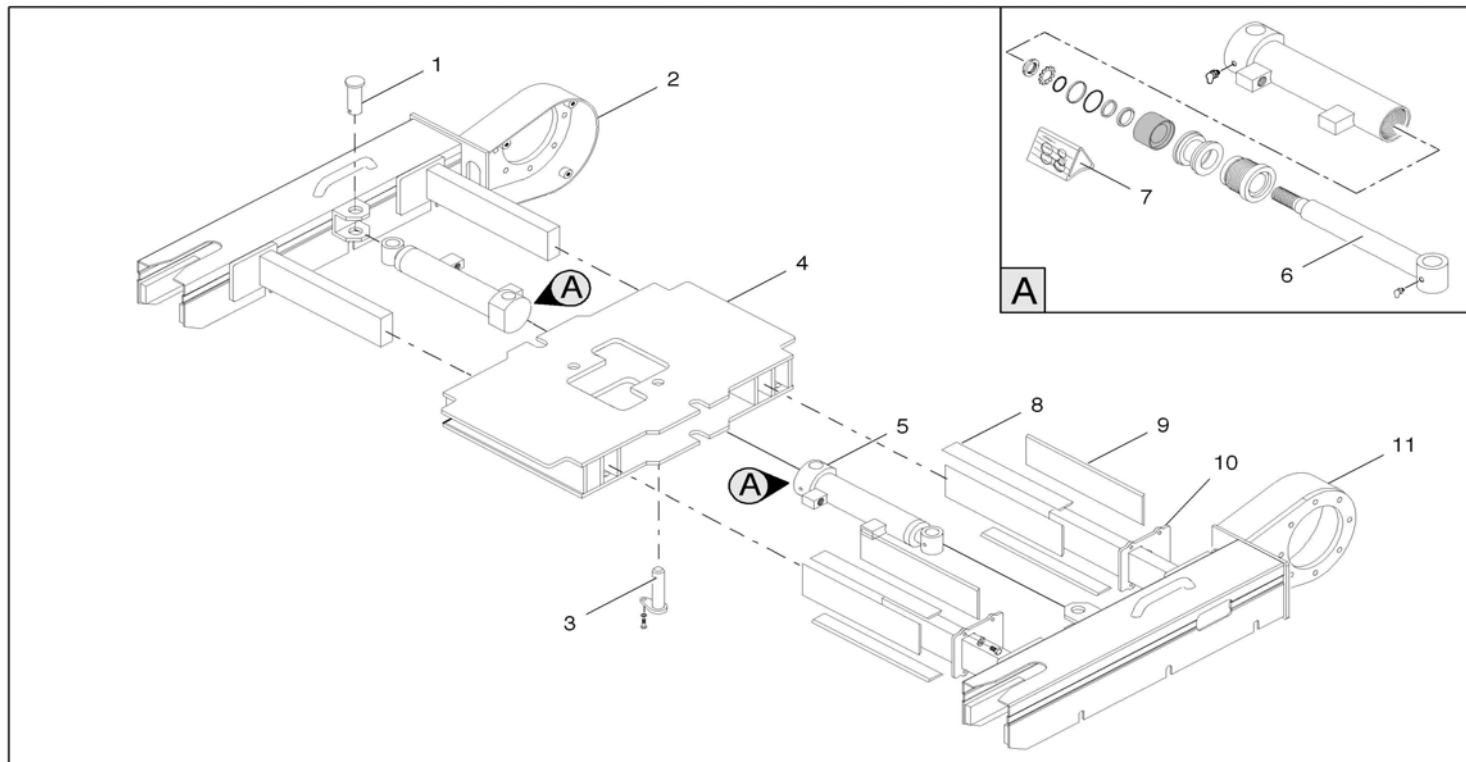





 <b>CARRO CON CINGOLO IN GOMMA</b>  <b>CHENILLARD AVEC CHENILLES EN CAOUTCHOUC</b>  <b>CARRO CON ORUGA DE GOMA</b>			<b>UNDERCARRIAGE WITH RUBBER TRACK</b>  <b>FAHRWERK MIT GUMMIKETTE</b>  <b>ONDERSTEL MET RUBBEREN RUPS BAND</b> 					
POS	Codice	Q.tà	 Descrizione	 Description	 Designation	 Benennung	 Descripción	 Beschrijving
01	053715LB	2 NR	CINGOLO IN GOMMA	RUBBER TRACK	CHENILLE EN CAOUTCHOUC	GUMMIRAUPE	ORUGA DE GOMA	RUBBEREN RUPS BAND
02	14753400	2 NR	SUPPORTO	SUPPORT	SUPPORT	HALTERUNG	SOPORTE	STEUN
03	34719500	1 NR	PIATTO	PLATE	PLATEAU	PLATTE	PLACA	PLAAT
04	03024800	1 NR	MOLLA	SPRING	RESSORT	FEDER	MUELLE	VEER
05	10681670	1 NR	CILINDRO	CYLINDER	VÉRIN	ZYLINDER	CILINDRO	CILINDER
06	03149200	1 NR	VALVOLA IDRAULICA	HYDRAULIC VALVE	VALVE HYDRAULIQUE	VALVE HYDRAULIQUE	VÁLVULA HIDRÁULICA	HYDRAULISCHE KLEP
07	15393700	2 NR	RUOTA TENDICINGOLO	IDLER WHEEL	ROUE TENDEUR DE CHENILLE	RAUPENSPANNRAD	RUEDA TENSOR ORUGA	SPANWIEL RUPS BAND
08	15385700	1 NR	SOTTOCARRO CINGOLATO	TRACKED UNDERCARRIAGE	CHENILLARD	RAUPENFAHRWERK	CARRO CON ORUGAS	ONDERSTEL OP RUPS BANDEN
09	05380900	2 NR	COPERCHIO	COVER	COUVERCLE	DECKEL	TAPA	DEKSEL
10	14505900	2 NR	MOTORIDUTTORE	GEAR MOTOR	MOTORÉDUCTEUR	GETRIEBEMOTOR	MOTORREDUCTOR	REDUCTIEMOTOR
11	15351500	6 NR	RULLO INFERIORE	CARRIER ROLLER	ROULEAU INFÉRIEUR	UNTERE ROLLER	RODILLO INFERIOR	ONDERSTE ROL
12	04173600	2 NR	RUOTA DI TRAZIONE	SPROCKET WHEEL	ROUE DE TRACTION	ANTRIEBSRAD	RUEDA DE ARRASTRE	DRIJFWIEL
13	1450590003	1 NR	VALVOLA IDRAULICA	HYDRAULIC VALVE	VALVE HYDRAULIQUE	VALVE HYDRAULIQUE	VÁLVULA HIDRÁULICA	HYDRAULISCHE KLEP
14	1450590002	1 NR	MOTORE IDRAULICO	HYDRAULIC MOTOR	MOTEUR HYDRAULIQUE	HYDRAULIKMOTOR	MOTOR HIDRÁULICO	HYDRAULISCHE MOTOR

 ALLARGAMENTO IDRAULICO  
 ECARTEMENT HYDRAULIQUE  
 EXTENSION HIDRAULICA

HYDRAULIC EXTENSION   
HYDR. SPURWEITENVERSTELLEINRICHTUNG   
VOOR HYDRAULISCHE VERBREDING 





 ALLARGAMENTO IDRAULICO  ECARTEMENT HYDRAULIQUE  EXTENSION HIDRAULICA				HYDRAULIC EXTENSION  HYDR. SPURWEITENVERSTELLEINRICHTUNG  VOOR HYDRAULISCHE VERBREDING 				
POS	Codice	Q.tà	 Descrizione	 Description	 Designation	 Benennung	 Descripcìon	 Beschrijving
01	04256300	2 NR	SPINA	PIN	CHEVILLE	STIF	CLAVIJA	STEKKER
02	35385700	1 NR	ASSIEME LONGHERONE DESTRO	RIGHT SIDE FRAME ASSEMBLY	ENSEMBLE CHÂSSIS LATÉRAL LONGERON DROIT	LÄNGSTRÄGERBAUGR UPPE RECHTS	CONJUNTO LARGUERO DERECHO	GEHEEL VAN R. LANGSLIGGER
03	05419700	2 NR	SPINA	PIN	CHEVILLE	STIF	CLAVIJA	STEKKER
04	35385300	1 NR	STRUTTURA	STRUCTURE	STRUCTURE	STRUKTUR	ESTRUCTURA	STRUCTUUR
05	14255300	2 NR	CILINDRO	CYLINDER	CYLINDER	ZYLINDER	CILINDRO	CILINDER
06	34735700	1 NR	STELO	ROD	TIGE	SCHAFT	VÁSTAGO	STEEL
07	14736000	1 NR	KIT GUARNIZIONI	GASKET KIT	KIT JOINTS	DICHTUNGSSATZ	KIT GUARNICIONES	KIT PAKKINGEN
08	04624900	8 NR	GUIDA ALLARGAMENTO	EXPANSION GUIDE	GLISSIÈRE ÉLARGISSEMENT	FÜHRUNGSVERBREIT ERUNG	GUÍA DE EXTENSIÓN	GELEIDER VERBREDING
09	04624800	8 NR	GUIDA ALLARGAMENTO	EXPANSION GUIDE	GLISSIÈRE ÉLARGISSEMENT	FÜHRUNGSVERBREIT ERUNG	GUÍA DE EXTENSIÓN	GELEIDER VERBREDING
10	34610800	4 NR	COPERCHIO	COVER	COUVERCLE	DECKEL	TAPA	DEKSEL
11	35385800	1 NR	ASSIEME LONGHERONE SINISTRO	LEFT SIDE FRAME ASSEMBLY	ENSEMBLE CHÂSSIS LATÉRAL LONG. GAUCHE	LÄNGSTRÄGERBAUGR UPPE LINKS	CONJUNTO LARGUERO IZQUIERDO	GEHEEL VAN L. LANGSLIGGER



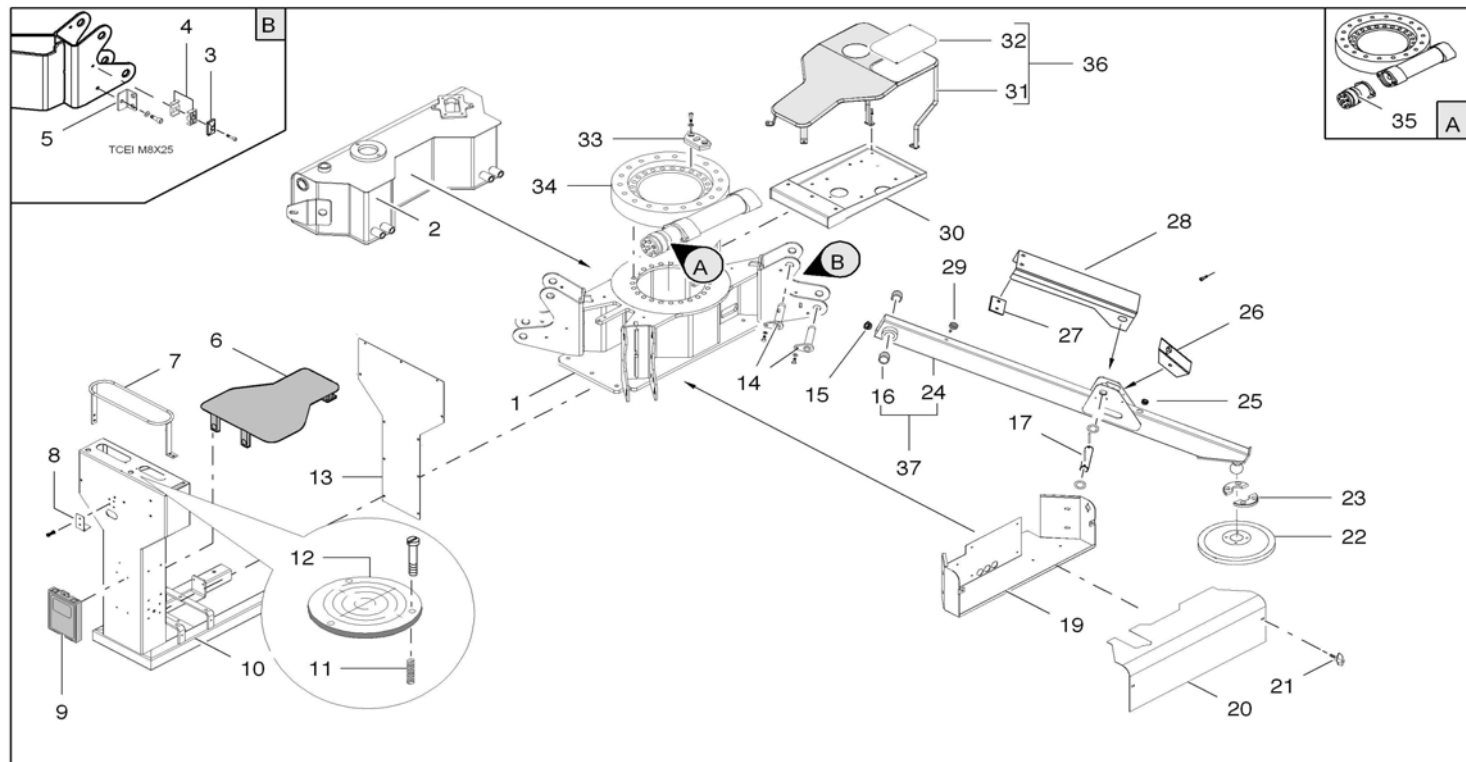

 **BASE TORRETTA**  
 **BASE TOURELLE**  
 **BASE TORRETA GIRATORIA**













**TURRET BASE**   
**ARBEITSTURM**   
**BASIS TORENTJE** 



 **BASE TORRETTA**  
 **BASE TOURELLE**  
 **BASE TORRETA GIRATORIA**

**TURRET BASE**   
**ARBEITSTURM**   
**BASIS TORENTJE** 

POS	Codice	Q.tà	 Descrizione	 Description	 Designation	 Benennung	 Descripción	 Beschrijving
01	35480400	1 NR	BASE PIATTAFORMA	PLATFORM BASE	BASE PLATEFORME	ARBEITSBÜHNENUNT ERGESTELL	BASE PLATAFORMA	BASIS PLATFORM
02	154442J0	1 NR	SERBATOIO OLIO COMPLETO	COMPLETE OIL TANK	RÉSERVOIR D'HUILE COMPLET	ÖLTANK KOMPLETT	DEPÓSITO DE ACEITE COMPLETO	COMPLETE OLIETANK
03	05625800	4 NR	PIASTRINA	PLATE	PLAQUETTE	PLÄTTCHEN	PLACA	PLAATJE
04	05333300	4 NR	COLLETTORE	MANIFOLD	COLLECTEUR	KOLLEKTOR	COLECTOR	COLLECTOR
05	05562900	1 NR	STAFFA	BRACKET	ÉTRIER	HALTEBÜGEL	ESTRIBO	BEUGEL
06	358013J0	1 NR	PROTEZIONE	PROTECTION	PROTECTION	SCHUTZ	PROTECCIÓN	BESCHERMING
07	35840200	1 NR	SUPPORTO	SUPPORT	SUPPORT	HALTERUNG	SOPORTE	STEUN
08	06541800	1 NR	MANIGLIA	HANDLE	POIGNÉE	GRIFF	MANIJA	HANDGREEP
09	05643600	1 NR	CASSETTA PORTAMANUALE	MANUAL BOX	BOÎTE PORTE-MANUEL	BEDIENUNGSANLEITUNG SFACH	CAJA PORTAMANUAL	KISTJE HANDLEIDING
10	354694J0	1 NR	SUPPORTO	SUPPORT	SUPPORT	HALTERUNG	SOPORTE	STEUN
11	05444800	3 NR	MOLLA	SPRING	RESSORT	FEDER	MUELLE	VEER
12	05427200	1 NR	LIVELLA	LEVEL	NIVEAU	WASSERWAAGE	NIVEL DE BURBUJA	WATERPAS
13	054685J0	1 NR	COPERCHIO	COVER	COUVERCLE	DECKEL	TAPA	DEKSEL
14	06229200	8 NR	SPINA	PIN	CHEVILLE	STIF	CLAVIJA	STEKKER
15	05981500	4 NR	PASSACAVO	CABLE PROTECTION	RACCORD CÂBLE	KABELDURCHGANG	PROTECCIÓN CABLES	KABELGELEIDER

 <b>BASE TORRETTA</b>  <b>BASE TOURELLE</b>  <b>BASE TORRETA GIRATORIA</b>			<b>TURRET BASE</b>  <b>ARBEITSTURM</b>  <b>BASIS TORENTJE</b> 					
POS	Codice	Q.tà	 Descrizione	 Description	 Designation	 Benennung	 Descripción	 Beschrijving
16	06272500	2 NR	BOCCOLA	BUSH	DOUILLE	BUCHSE	CASQUILLO	BUS
17	06230700	4 NR	SPINA	PIN	CHEVILLE	STIF	CLAVIJA	STEKKER
20	054687J0	1 NR	COPERCHIO	COVER	COUVERCLE	DECKEL	TAPA	DEKSEL
21	05611000	5 NR	GALLETTO	WING NUT	ECROU PAPILLON	FLÜGELMUTTER	TUERCA DE MARIPOSA	VLEUGELMOER
22	05446300	4 NR	DISCO	DISK	DISQUE	SCHEIBE	DISCO	SCHIJF
23	05446400	4 NR	SEMIFLANGIA	HALF FLANGE	DEMI-BRIDE	HALB FLANSCH	SEMI BRIDA	HALVE FLENS
24	354461J0	1 NR	STABILIZZATORE	STABILIZER	STABILISATEUR	STABILIZER	ESTABILIZADOR	STABILIZER
25	05981400	4 NR	PASSACAVO	CABLE PROTECTION	RACCORD CÂBLE	KABELDURCHGANG	PROTECCIÓN CABLES	KABELGELEIDER
26	35618300	4 NR	CARTER	SUMP	CARTER	KURBELGEHÄUSE	CÁRTER	CÁRTER
27	05534400	4 NR	PIATTO	PLATE	PLATEAU	PLATTE	PLACA	PLAAT
28	05472500	4 NR	PROTEZIONE	PROTECTION	PROTECTION	SCHUTZ	PROTECCIÓN	BESCHERMING
29	05475900	4 NR	ANTIVIBRANTE	ANTI-VIBRATING	ANTI - VIBRANT	VIBRATIONS DÄMPFER	ANTIVIBRANTE	ANTI-TRILELEMENT
30	354691J0	1 NR	SUPPORTO	SUPPORT	SUPPORT	HALTERUNG	SOPORTE	STEUN
31	358016J0	1 NR	PROTEZIONE	PROTECTION	PROTECTION	SCHUTZ	PROTECCIÓN	BESCHERMING
33	35561700	1 NR	FERMO	RETAINER	ARRÊT	HALTERUNG	BLOQUE	BLOKKERING
34	25502300	1 NR	RALLA	FIFTH WHEEL	COURONNE DENTÉE	DREHKRANZ	TEJUELO	DRAAITAFEL
35	25502200	1 NR	MOTORE DI ROTAZIONE	ROTARY MOTOR	MOTEUR DE ROTATION	ROTATIONSMOTOR	MOTOR DE ROTACIÓN	ROTATIEMOTOR

 **BASE TORRETTA** **BASE TOURELLE** **BASE TORRETA GIRATORIA****TURRET BASE** **ARBEITSTURM** **BASIS TORENTJE** 

POS	Codice	Q.tà	 Descrizione	 Description	 Designation	 Benennung	 Descripción	 Beschrijving
37	162803J0	4 NR	STABILIZZATORE COMPLETO	COMPLETE STABILIZER	STABILISATEUR COMPLET	STABILIZER KOMPLETT	ESTABILIZADOR COMPLETO	COMPLETE STABILIZE

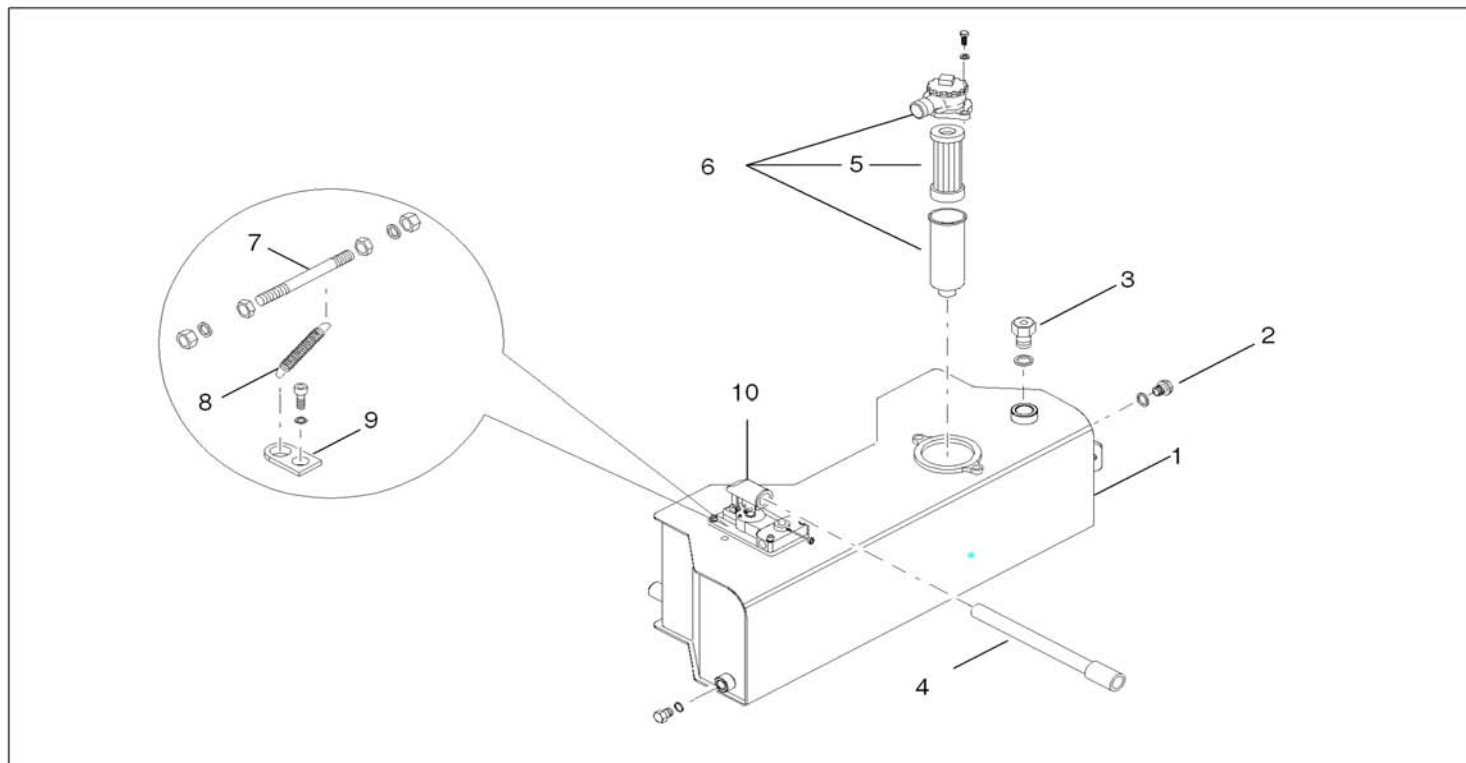

 **SERBATOIO OLIO**  
 **RÉSERVOIR D'HUILE**  
 **DEPÓSITO DE ACEITE**

**OIL TANK**   
**ÖLTANK**   
**OLIETANK** 

POS	Codice	Q.tà	 Descrizione	 Description	 Designation	 Benennung	 Descripción	 Beschrijving
01	354442J0	1 NR	SERBATOIO OLIO	OIL TANK	RÉSERVOIR D'HUILE	ÖLTANK	DEPÓSITO DE ACEITE	OLIETANK
02	05061800	1 NR	LIVELLO OLIO	OIL LEVEL	NIVEAU HUILE	ÖLSTAND	NIVEL ACEITE	OLIEPEIL
03	05611800	1 NR	TAPPO OLIO	OIL PLUG	BOUCHON D'HUILE	ÖLDECKEL	TAPÓN ACEITE	OLIEDOP
04	05521300	1 NR	LEVA	LEVER	LEVIER	HEBEL	PALANCA	HENDEL
05	05120200	1 NR	FILTRO OLIO	OIL FILTER	FILTRE À HUILE	ÖLFILTER	FILTRO ACEITE	OLIEFILTER
06	15120100	1 NR	FILTRO OLIO	OIL FILTER	FILTRE À HUILE	ÖLFILTER	FILTRO ACEITE	OLIEFILTER
07	05571800	1 NR	TIRANTE	TIE ROD	TIRANT	TURMGESTÄNGE	TIRANTE	TREKSTANG
08	05392700	2 NR	MOLLA	SPRING	RESSORT	FEDER	MUELLE	VEER
09	05571700	2 NR	PIASTRA	PLATE	PLATINE	PLATTE	PLACA	PLAAT
10	25508900	1 NR	POMPA A MANO	HAND PUMP	POMPE MANUELLE	HANDPUMPE	BOMBA DE MANO	HANDPOMP

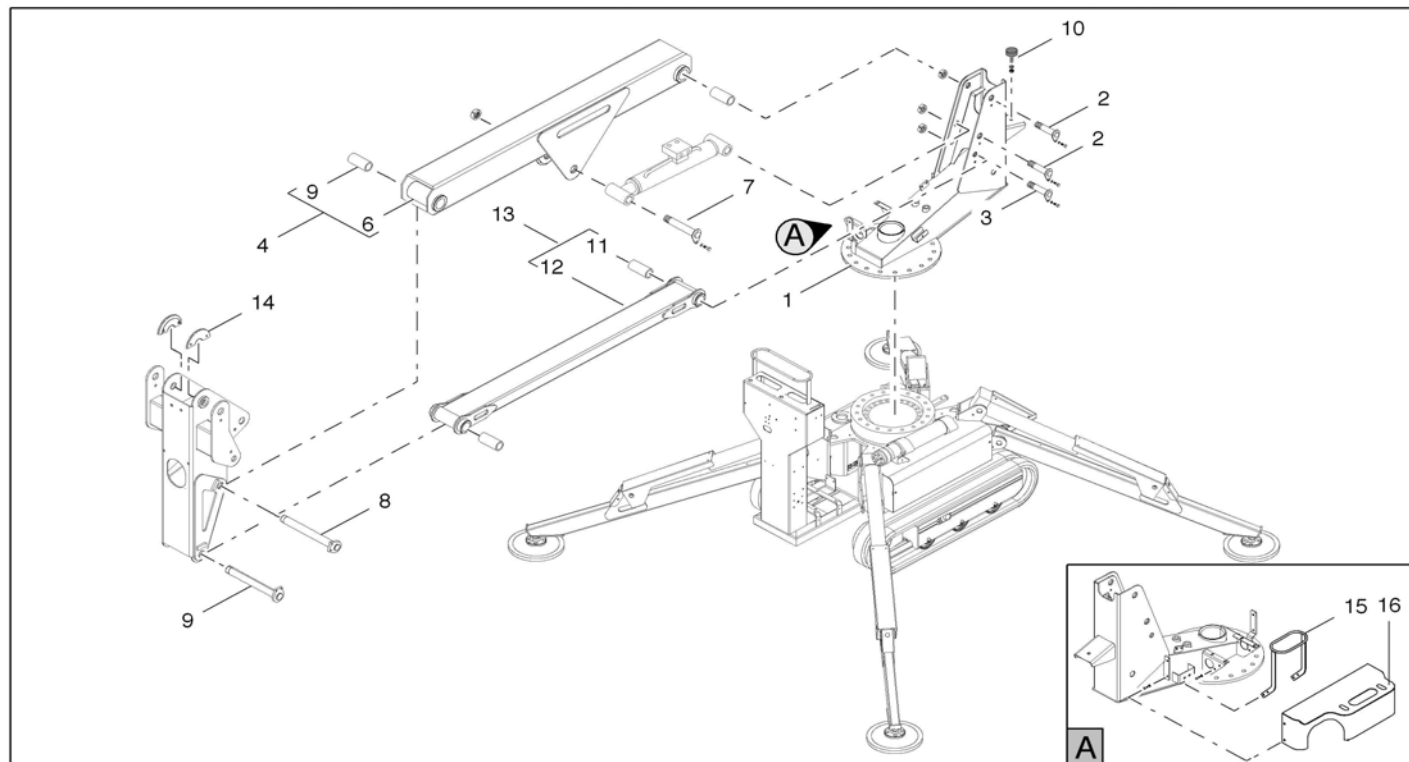









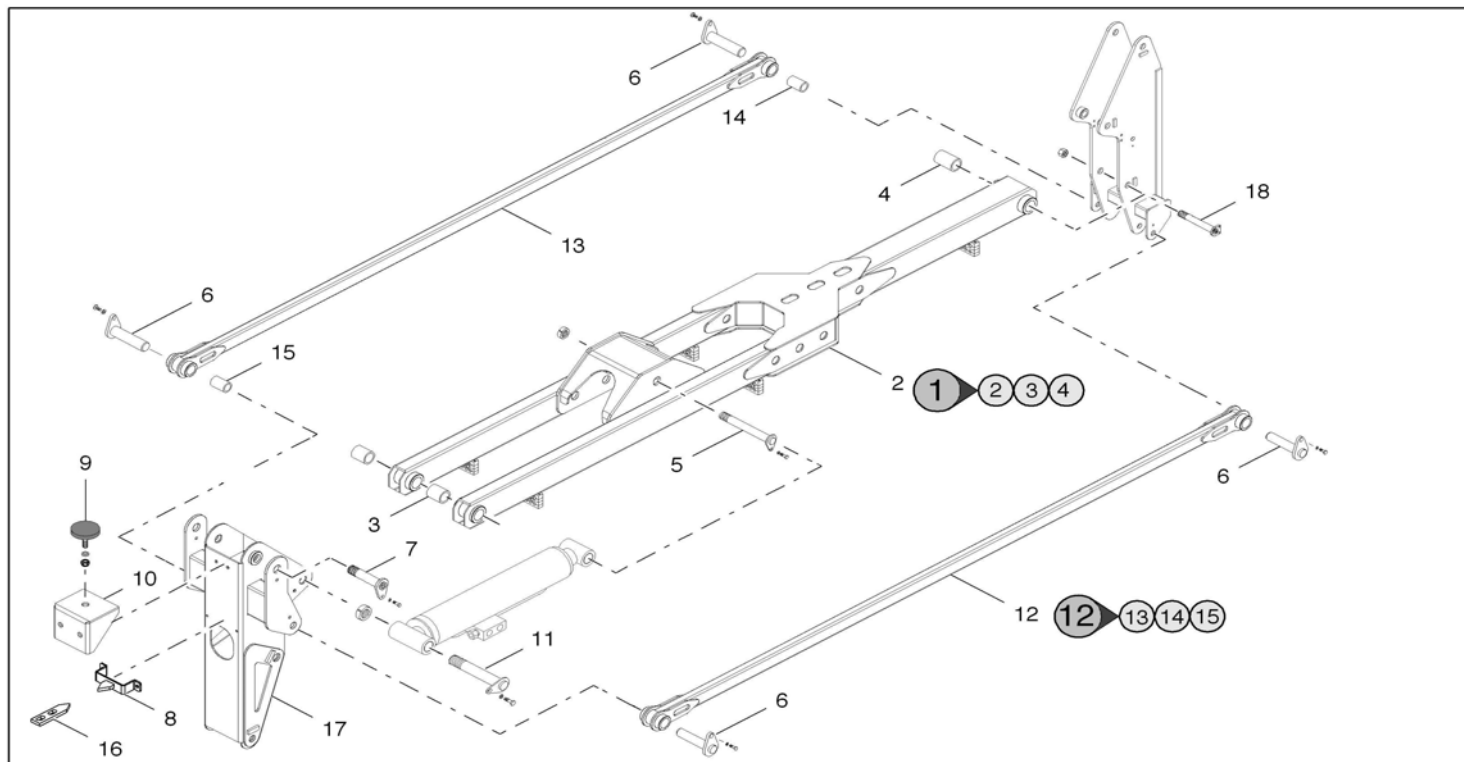





 PRIMO BRACCIO									FIRST ARM 
 PREMIER BRAS									ERSTER AUSLEGERARM 
 PRIMO BRAZO									EERSTE ARM 
POS	Codice	Q.tà	 Descrizione	 Description	 Designation	 Benennung	 Descripcìon	 Beschrijving	
01	354475J0	1 NR	SUPPORTO	SUPPORT	SUPPORT	HALTERUNG	SOPORTE	STEUN	
02	06229400	3 NR	SPINA	PIN	CHEVILLE	STIF	CLAVIJA	STEKKER	
03	06229300	1 NR	SPINA	PIN	CHEVILLE	STIF	CLAVIJA	STEKKER	
04	162794J0	1 NR	PRIMO BRACCIO COMPLETO	COMPLETE FIRST ARM	PREMIER BRAS COMPLÈTE	ERSTE ARM ERGÄNZEN	PRIMO BRAZO COMPLETO	EERSTE ARM VOLLEDIGE	
05	354481J0	1 NR	PRIMO BRACCIO	FIRST ARM	PREMIER BRAS	ERSTER AUSLEGERARM	PRIMO BRAZO	EERSTE ARM	
06	06272400	4 NR	BOCCOLA	BUSH	DOUILLE	BUCHSE	CASQUILLO	BUS	
07	06229500	2 NR	SPINA	PIN	CHEVILLE	STIF	CLAVIJA	STEKKER	
08	06229700	1 NR	SPINA	PIN	CHEVILLE	STIF	CLAVIJA	STEKKER	
09	06229600	1 NR	SPINA	PIN	CHEVILLE	STIF	CLAVIJA	STEKKER	
10	05522000	2 NR	ANTIVIBRANTE	ANTI- VIBRATING	ANTI - VIBRANT	VIBRATIONSDÄMPFER	ANTIVIBRANTE	ANTI- TRILELEMENT	
11	06280700	4 NR	BOCCOLA	BUSH	DOUILLE	BUCHSE	CASQUILLO	BUS	
12	354486J0	1 NR	TIRANTE	TIE ROD	TIRANT	TURMGESTÄNGE	TIRANTE	TREKSTANG	
13	162795J0	1 NR	TIRANTE COMPLETO	COMPLETE TIE ROD	LIENS COMPLETS	VOLLSTÄNDIGE VERKNÜPFUNG	LIGAMIENTO COMPLETO	VOLLEDIGE KOPPELING	
14	05691500	2 NR	PATTINO	SLIDE BLOCK	PATIN	GLEITBLOCK	PATÍN	GLIJBLOK	
15	35502000	1 NR	APPOGGIO MANI	HANDREST	APPUI-MAIN	HANDSTÜTZE	APOYO MANOS	HANDENSTEUN	
16	05551200	1 NR	PROTEZIONE	PROTECTION	PROTECTION	SCHUTZ	PROTECCIÓN	BESCHERMING	

 **SECONDO BRACCIO**  
 **SECOND BRAS**  
 **SEGUNDO BRAZO**

**SECOND ARM**   
**ZWEITER AUSLEGERARM**   
**TWEDE ARM** 



 <b>SECONDO BRACCIO</b>  <b>SECOND BRAS</b>  <b>SEGUNDO BRAZO</b>			<b>SECOND ARM</b>  <b>ZWEITER AUSLEGERARM</b>  <b>TWEEDE ARM</b> 					
POS	Codice	Q.tà	 Descrizione	 Description	 Designation	 Benennung	 Descripción	 Beschrijving
01	162796J0	1 NR	SECONDO BRACCIO COMPLETO	COMPLETE SECOND ARM	DEUXIÈME BRAS COMPLÈTE	ZWEITER ARM ERGÄNZEN	SEGUNDO BRAZO COMPLETO	TWEEDE ARM TE VOLTOOIEN
02	354551J0	1 NR	SECONDO BRACCIO	SECOND ARM	SECOND BRAS	ZWEITER AUSLEGERARM	SEGUNDO BRAZO	TWEEDE ARM
03	06272200	4 NR	BOCCOLA	BUSH	DOUILLE	BUCHSE	CASQUILLO	BUS
04	06272400	2 NR	BOCCOLA	BUSH	DOUILLE	BUCHSE	CASQUILLO	BUS
05	06229800	1 NR	SPINA	PIN	CHEVILLE	STIF	CLAVIJA	STEKKER
06	06229000	4 NR	SPINA	PIN	CHEVILLE	STIF	CLAVIJA	STEKKER
07	06229100	2 NR	SPINA	PIN	CHEVILLE	STIF	CLAVIJA	STEKKER
08	05506600	1 NR	FERMO	RETAINER	ARRÊT	HALTERUNG	BLOQUE	BLOKKERING
09	05522000	1 NR	ANTIVIBRANTE	ANTI-VIBRATING	ANTI - VIBRANT	VIBRATIONS DÄMPFER	ANTIVIBRANTE	ANTI-TRILELEMENT
10	05534900	1 NR	SUPPORTO	SUPPORT	SUPPORT	HALTERUNG	SOPORTE	STEUN
11	06229400	1 NR	SPINA	PIN	CHEVILLE	STIF	CLAVIJA	STEKKER
12	162797J0	2 NR	TIRANTE COMPLETO	COMPLETE TIE ROD	LIENS COMPLETS	VOLLSTÄNDIGE VERKNÜPFUNG	LIGAMIENTO COMPLETO	VOLLEDIGE KOPPELING
13	354555J0	1 NR	TIRANTE	TIE ROD	TIRANT	TURMGESTÄNGE	TIRANTE	TREKSTANG
14	06611400	1 NR	BOCCOLA	BUSH	DOUILLE	BUCHSE	CASQUILLO	BUS
15	06611500	1 NR	BOCCOLA	BUSH	DOUILLE	BUCHSE	CASQUILLO	BUS
16	05618400	1 NR	INDICE ALLINEAMENTO	ALIGNMENT INDICATOR	INDICATEUR D'ALIGNEMENT	AUSRICHTUNGSANZEIGE	INDICADOR ALINEACIÓN	INDEX UITLIJNING

 **SECONDO BRACCIO**
 **SECOND BRAS**
 **SEGUNDO BRAZO**
**SECOND ARM** 
**ZWEITER AUSLEGERARM** 
**TWEEDE ARM** 









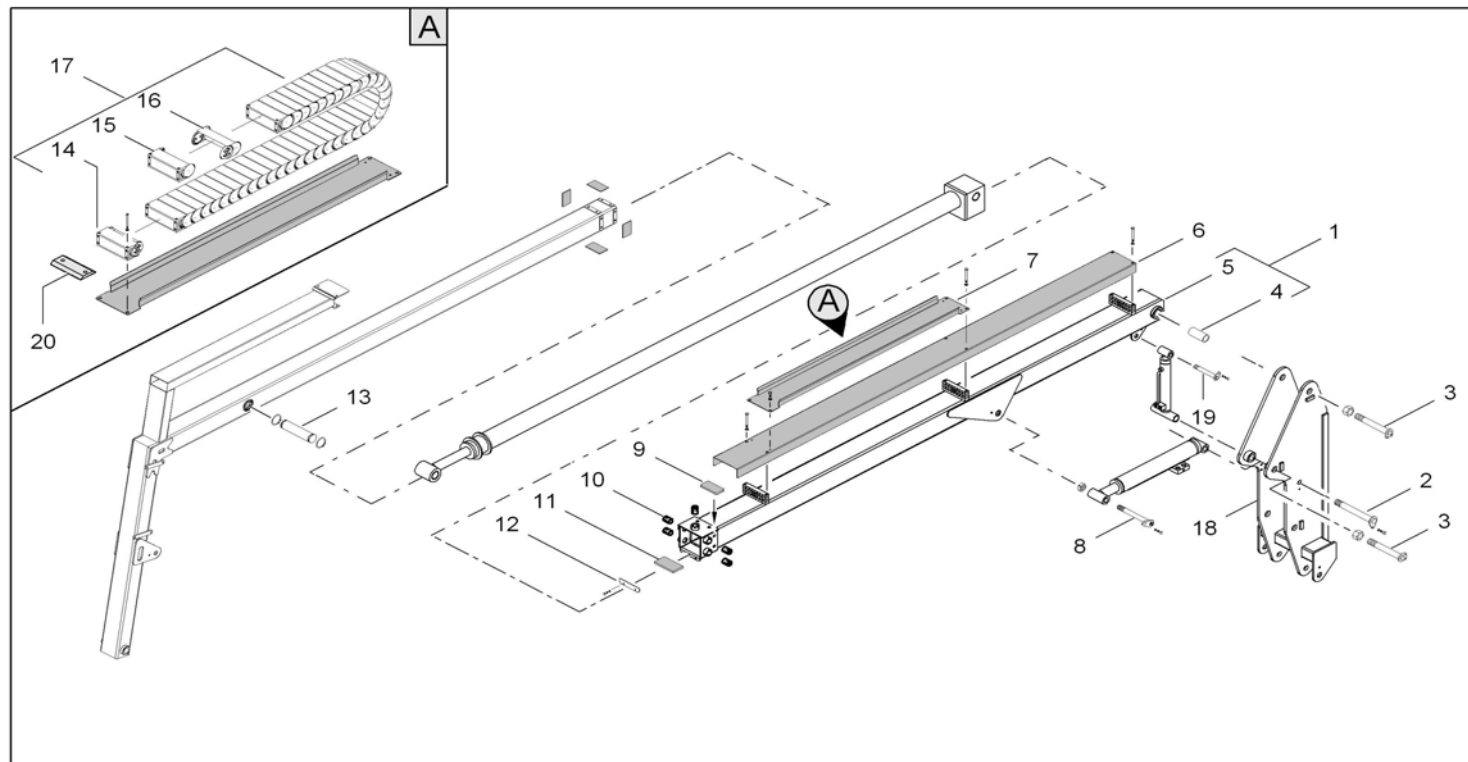



POS	Codice	Q.tà	 Descrizione	 Description	 Designation	 Benennung	 Descripción	 Beschrijving
17	354539J0	1 NR	RINVIO	TRANSMISSION	REVOI	VORGELEGE	REENVIO	OVERBRENGING
18	06229900	3 NR	SPINA	PIN	CHEVILLE	STIF	CLAVIJA	STEKKER



 **TERZO BRACCIO**  
 **TROISIÈME BRAS**  
 **TERCER BRAZO**

**THIRD ARM**   
**DRITTER AUSLEGERARM**   
**DERDE ARM** 



 <b>TERZO BRACCIO</b>  <b>TROISIÈME BRAS</b>  <b>TERCER BRAZO</b>			<b>THIRD ARM</b>  <b>DRITTER AUSLEGERARM</b>  <b>DERDE ARM</b> 					
POS	Codice	Q.tà	 Descrizione	 Description	 Designation	 Benennung	 Descripción	 Beschrijving
01	165707J0	1 NR	TERZO BRACCIO	THIRD ARM	TROISIÈME BRAS	DRITTER AUSLEGERARM	TERCER BRAZO	DERDE ARM
02	06228900	1 NR	SPINA	PIN	CHEVILLE	STIF	CLAVIJA	STEKKER
03	06229900	2 NR	SPINA	PIN	CHEVILLE	STIF	CLAVIJA	STEKKER
04	06272200	2 NR	BOCCOLA	BUSH	DOUILLE	BUCHSE	CASQUILLO	BUS
05	365707J0	1 NR	TERZO BRACCIO	THIRD ARM	TROISIÈME BRAS	DRITTER AUSLEGERARM	TERCER BRAZO	DERDE ARM
06	06570600	1 NR	PROTEZIONE	PROTECTION	PROTECTION	SCHUTZ	PROTECCIÓN	BESCHERMING
07	06569300	1 NR	CANALINA	CABLE CONDUIT	RIGOLE	FÜHRUNGSBLECH	CANALETA	GELEIDER
08	06229500	1 NR	SPINA	PIN	CHEVILLE	STIF	CLAVIJA	STEKKER
09	06571800	1 NR	PATTINO	SLIDE BLOCK	PATIN	GLEITBLOCK	PATÍN	GLIJBLOK
10	05804700	5 NR	PATTINO	SLIDE BLOCK	PATIN	GLEITBLOCK	PATÍN	GLIJBLOK
11	05917800	1 NR	PATTINO	SLIDE BLOCK	PATIN	GLEITBLOCK	PATÍN	GLIJBLOK
12	05804800	1 NR	PATTINO	SLIDE BLOCK	PATIN	GLEITBLOCK	PATÍN	GLIJBLOK
13	06230000	1 NR	SPINA	PIN	CHEVILLE	STIF	CLAVIJA	STEKKER
14	2552220002	1 NR	MAGLIA CATENA	CHAIN LINK	MAILLOT CHAÎNE	KETTENGLIED	ESLABÓN CADENA	SCHAKEL KETTING
15	2552220003	1 NR	MAGLIA CATENA	CHAIN LINK	MAILLOT CHAÎNE	KETTENGLIED	ESLABÓN CADENA	SCHAKEL KETTING
16	2552220001	1 NR	MAGLIA CATENA	CHAIN LINK	MAILLOT CHAÎNE	KETTENGLIED	ESLABÓN CADENA	SCHAKEL KETTING
17	25522200	1 NR	CATENA PORTACAVI	CABLE-HOLDER CHAIN	CHAÎNE PORTE-CÂBLES	KABELHALTERKETTE	CADENA PORTACABLES	VOLLEDIGE KABELHOUDERKETTING

 **TERZO BRACCIO**  
 **TROISIÈME BRAS**  
 **TERCER BRAZO**

**THIRD ARM**   
**DRITTER AUSLEGERARM**   
**DERDE ARM** 

POS	Codice	Q.tà	 Descrizione	 Description	 Designation	 Benennung	 Descripción	 Beschrijving
18	354561J0	1 NR	RINVIO	TRANSMISSION	REVOI	VORGELEGE	REENVIO	OVERBRENGING
19	06228700	1 NR	SPINA	PIN	CHEVILLE	STIF	CLAVIJA	STEKKER
20	05569900	1 NR	PIASTRA	PLATE	PLATINE	PLATTE	PLACA	PLAAT









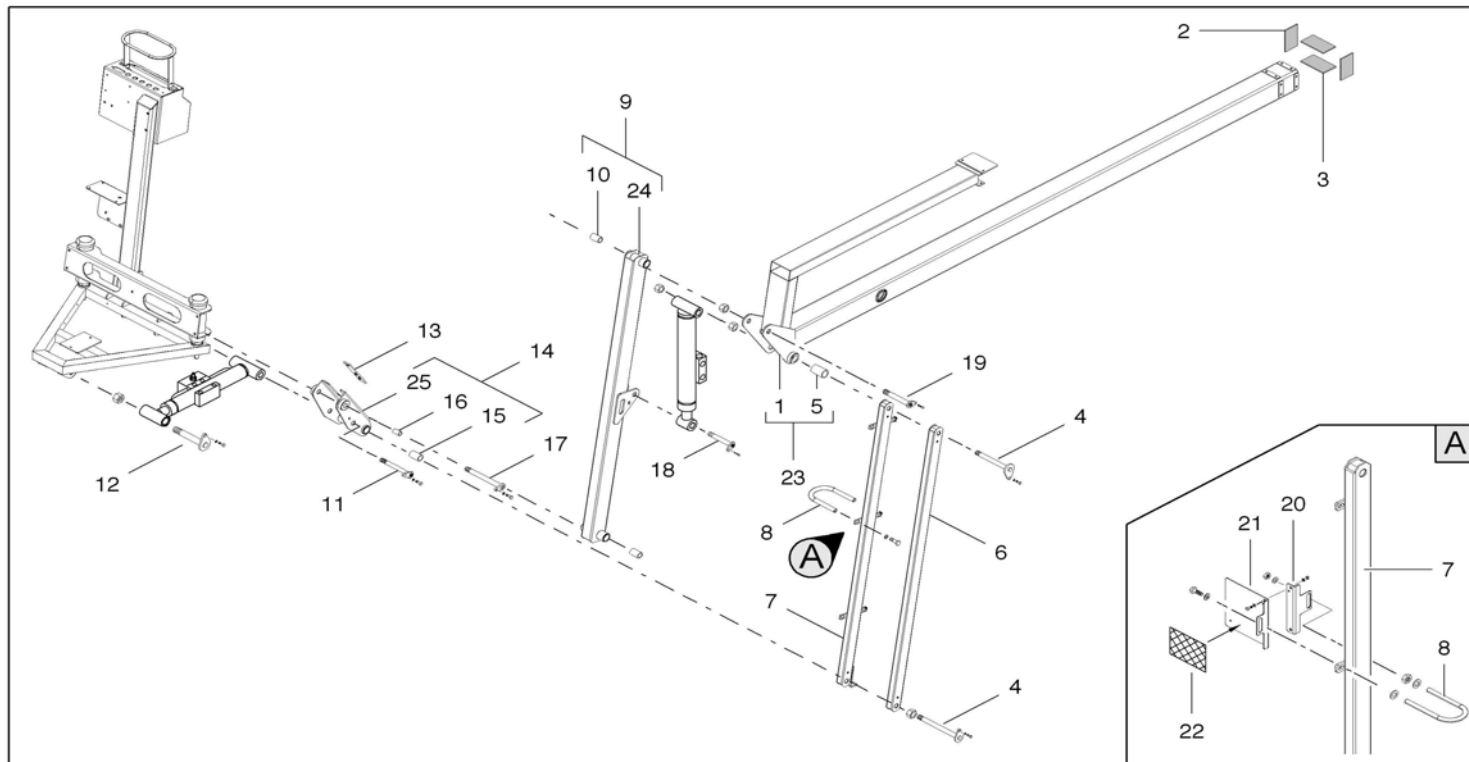



















 BRACCI-SFILO E JIB  
 BRAS-SECTION TELESCOPIQUE ET FLECHETTE  
 BRAZO ARTICULADO-BRAZO TELESCOPICO Y PLUMA

ARMS-TELESCOPIC EXTENSION AND JIB   
ARME-TELESKOP UND SCHWENKARM   
ARMESECTIE-EXTRACTIE EN JIB 



 <b>BRACCI-SFILO E JIB</b>  <b>BRAS-SECTION TELESCOPIQUE ET FLECHETTE</b>  <b>BRAZO ARTICULADO-BRAZO TELESCOPICO Y PLUMA</b>			<b>ARMS-TELESCOPIC EXTENSION AND JIB</b>  <b>ARME-TELESKOP UND SCHWENKARM</b>  <b>ARMESECTIE-EXTRACTIE EN JIB</b> 					
POS	Codice	Q.tà	 Descrizione	 Description	 Designation	 Benennung	 Descripción	 Beschrijving
01	162799J0	1 NR	BRACCIO SFILO COMPLETO	COMPLETE ARM EXTENSION	BRAS EXTENSION COMPLÈTE	ARM ERWEITERUNG ERGÄNZEN	BRAZO EXTENSIÓN COMPLETO	ARM UITBREIDING VOLLEDIGE
02	05274000	2 NR	GUIDA	GUIDE	GLISSIÈRE	FÜHRUNG	GUÍA	GELEIDER
03	05274100	2 NR	GUIDA	GUIDE	GLISSIÈRE	FÜHRUNG	GUÍA	GELEIDER
04	06230400	2 NR	GUIDA	GUIDE	GLISSIÈRE	FÜHRUNG	GUÍA	GELEIDER
05	06272600	2 NR	BOCCOLA	BUSH	DOUILLE	BUCHSE	CASQUILLO	BUS
06	355381J0	1 NR	TIRANTE	TIE ROD	TIRANT	TURMGESTÄNGE	TIRANTE	TREKSTANG
07	355380J0	1 NR	TIRANTE	TIE ROD	TIRANT	TURMGESTÄNGE	TIRANTE	TREKSTANG
08	05507000	4 NR	FERMO	RETAINER	ARRÊT	HALTERUNG	BLOQUE	BLOKKERING
09	162800J0	1 NR	BRACCIO JIB COMPLETO	COMPLETE JIB ARM	FLÉCHETTE BRAS COMPLÈTE	ARM - SCHWENKARM	BRAZO JIB COMPLETO	ARM - JIB VOLLEDIGE
10	06272700	4 NR	BOCCOLA	BUSH	DOUILLE	BUCHSE	CASQUILLO	BUS
11	06228800	1 NR	SPINA	PIN	CHEVILLE	STIF	CLAVIJA	STEKKER
12	06230600	1 NR	SPINA	PIN	CHEVILLE	STIF	CLAVIJA	STEKKER
13	05598800	1 NR	STAFFA	BRACKET	ÉTRIER	HALTEBÜGEL	ESTRIBO	BEUGEL
14	162801J0	1 NR	SNODO COMPLETO	COMPLETE ARTICULATION	ARTICULATION COMPLÈTE	GELENK KOMPLETT	ARTICULACIÓN COMPLETO	COMPLETE VERBINDING
15	06272700	2 NR	BOCCOLA	BUSH	DOUILLE	BUCHSE	CASQUILLO	BUS







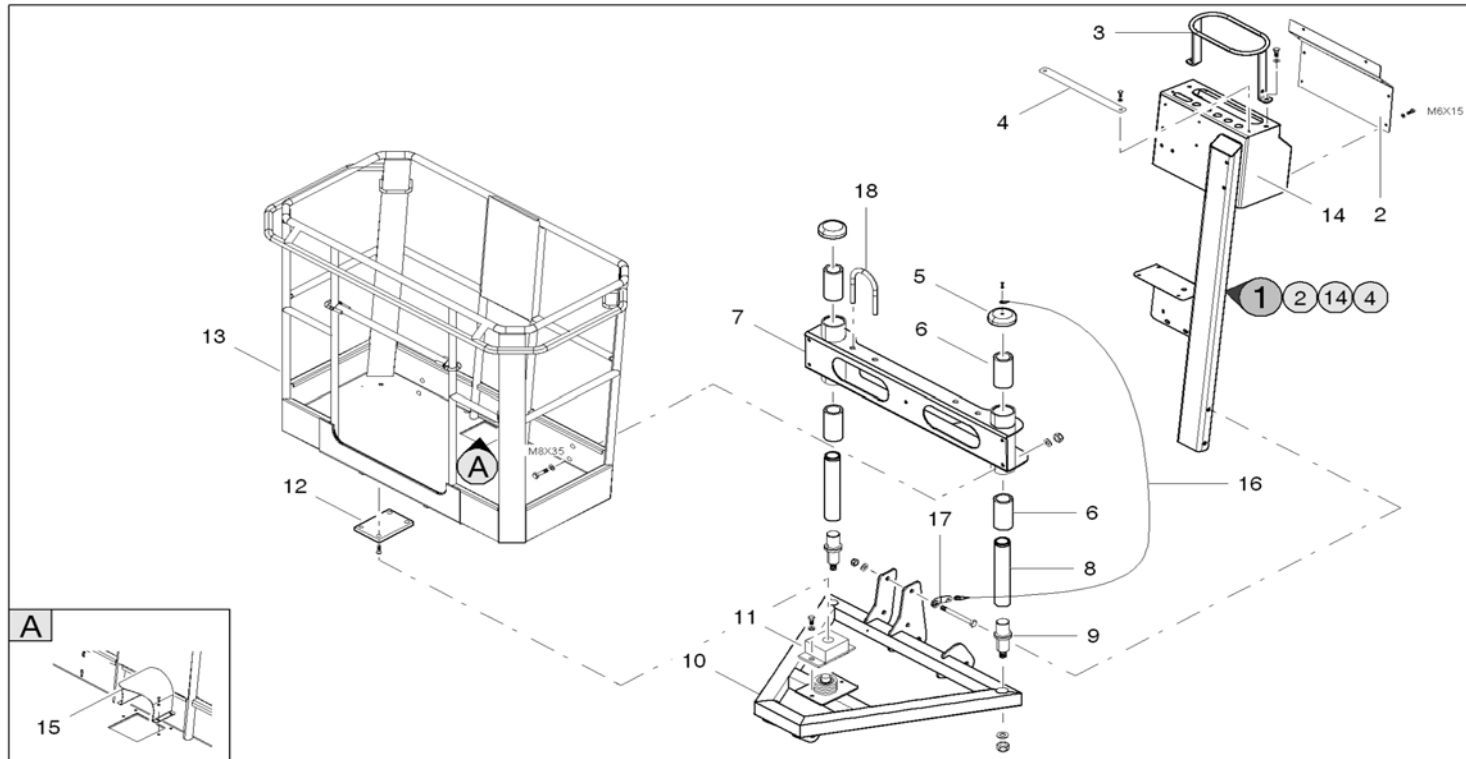

 <b>BRACCI-SFILO E JIB</b>			<b>ARMS-TELESCOPIC EXTENSION AND JIB</b> 					
 <b>BRAS-SECTION TELESCOPIQUE ET FLECHETTE</b>			<b>ARME-TELESKOP UND SCHWENKARM</b> 					
 <b>BRAZO ARTICULADO-BRAZO TELESCOPICO Y PLUMA</b>			<b>ARMESECTIE-EXTRACTIE EN JIB</b> 					
POS	Codice	Q.tà	 Descrizione	 Description	 Designation	 Benennung	 Descripción	 Beschrijving
16	06272600	2 NR	BOCCOLA	BUSH	DOUILLE	BUCHSE	CASQUILLO	BUS
17	06230500	1 NR	SPINA	PIN	CHEVILLE	STIF	CLAVIJA	STEKKER
18	06230300	1 NR	SPINA	PIN	CHEVILLE	STIF	CLAVIJA	STEKKER
19	06230200	1 NR	SPINA	PIN	CHEVILLE	STIF	CLAVIJA	STEKKER
20	06749700	1 NR	SUPPORTO	SUPPORT	SUPPORT	HALTERUNG	SOPORTE	STEUN
21	06749600	1 NR	SUPPORTO	SUPPORT	SUPPORT	HALTERUNG	SOPORTE	STEUN
22	1662840001	1 NR	CATARIFRANGENTE	REFLECTOR	CATADIOPTRE	REFLEKTOR	CATADIÓPTRICO	REFLECTOR
23	355238J0	1 NR	BRACCIO SFILO	ARM EXTENSION	BRAS EXTENSION	ARM ERWEITERUNG	BRAZO EXTENSIÓN	ARM UITBREIDING
24	355242J0	1 NR	BRACCIO JIB	JIB ARM	FLÉCHETTE BRAS	ARM - SCHWENKARM ERGÄNZEN	BRAZO JIB	ARM - JIB
25	362801J0	1 NR	SNODO	ARTICULATION	ARTICULATION	GELENK	ARTICULACIÓN	VERBINDING



 **SUPPORTO CESTO**  
 **PANIER CUPPORT**  
 **SOPORTE CESTA**

**BASKET SUPPORT**   
**HALTERUNG ARBEITSKORB**   
**ONDERSTEUNEN WERKBAK** 



 <b>SUPPORTO CESTO</b>  <b>PANIER CUPPORT</b>  <b>SOPORTE CESTA</b>			<b>BASKET SUPPORT</b>  <b>HALTERUNG ARBEITSKORB</b>  <b>ONDERSTEUNEN WERKBAK</b> 					
POS	Codice	Q.tà	 Descrizione	 Description	 Designation	 Benennung	 Descripcìon	 Beschrijving
01	159054J0	1 NR	SUPPORTO	SUPPORT	SUPPORT	HALTERUNG	SOPORTE	STEUN
02	054732J0	1 NR	COPERCHIO	COVER	COUVERCLE	DECKEL	TAPA	DEKSEL
03	35839500	1 NR	MANIGLIA	HANDLE	POIGNÉE	GRIFF	MANIJA	HANDGREEP
04	055632J0	1 NR	PIASTRA	PLATE	PLATINE	PLATTE	PLACA	PLAAT
05	06058300	2 NR	TAPPO	CAP	BOUCHON	VERSCHLUSS	TAPÓN	DOP
06	26084300	4 NR	CUSCINETTO	BEARING	COUSSINET	LAGER	COJINETE	LAGER
07	36057800	1 NR	SLITTA	SLIDE	COULISSEAU	SCHLITTEN	CORREDERA	SLEDE
08	05863600	2 NR	TUBO RIGIDO	RIGID PIPE	TUYAU RIGIDE	ROHR	TUBO RÍGIDO	OMBUIGZAME LEIDING
09	05863700	2 NR	PERNO	PIN	GOUJON	ZAPFEN	PERNIO	SPIL
10	35887000	1 NR	SUPPORTO CESTO	BASKET SUPPORT	PANIER SUPPORT	HALTERUNG ARBEITSKORB	SOPORTE CESTA	ONDERSTEUNEN WERKBAK
11	05618700	1 NR	COPERCHIO	BOX	COUVERCLE	DECKEL	TAPA	DEKSEL
12	05860000	1 NR	PIASTRA	PLATE	PLATINE	PLATTE	PLACA	PLAAT
13	25905600	1 NR	CESTO 2 PERSONE	TWO-PERSON BASKET	PANIER 2 PERSONNES	2 MANN-ARBEITSKORB	CESTA 2 PERSONAS	WERKBAK 2 PERSONEN
14	359054J0	1 NR	SUPPORTO	SUPPORT	SUPPORT	HALTERUNG	SOPORTE	STEUN
15	06418600	1 NR	PROTEZIONE	PROTECTION	PROTECTION	SCHUTZ	PROTECCIÓN	BESCHERMING
16	06665000	2 NR	FUNE	CABLE	CÂBLE	SEIL	CABLE	KOORD

 **SUPPORTO CESTO**  
 **PANIER CUPPORT**  
 **SOPORTE CESTA**

**BASKET SUPPORT**   
**HALTERUNG ARBEITSKORB**   
**ONDERSTEUNEN WERKBAK** 

POS	Codice	Q.tà	 Descrizione	 Description	 Designation	 Benennung	 Descripcìon	 Beschrijving
17	07052900	1 NR	STAFFA	BRACKET	ÉTRIER	HALTEBÜGEL	ESTRIBO	BEUGEL
18	07031800	2 NR	TUBO	PIPE	TUYAU	ROHR	TUBO	BUIS









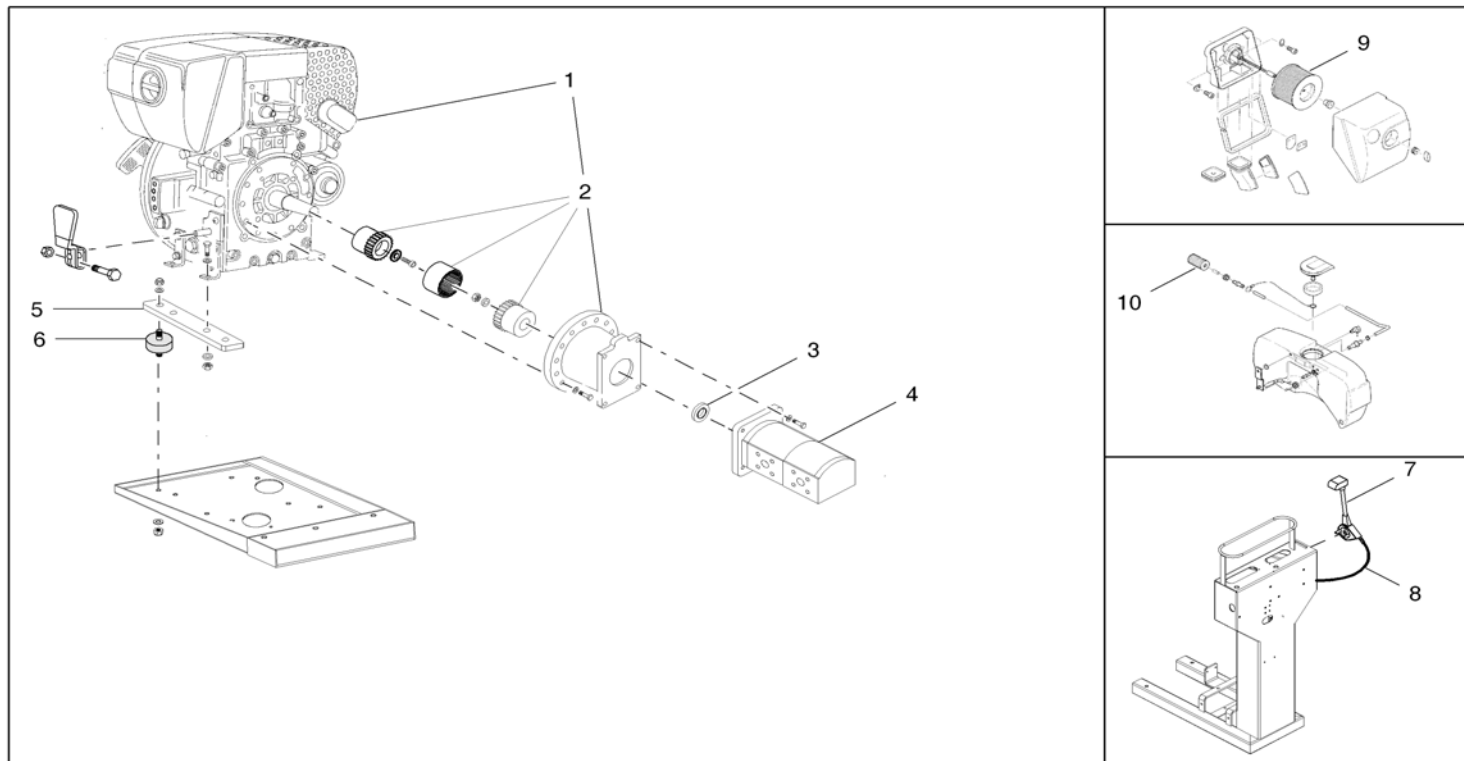

 ACCOPPIAMENTO MOTORE - POMPA  
 ACCOUPLEMENT MOTEUR- POMPE  
 ACOPLAMIENTO MOTOR - BOMBA

ENGINE COUPLING - PUMP   
PUMPEN / MOTOR KUPPLUNG   
KOPPELING MOTOR - POMP 



 **ACCOPPIAMENTO MOTORE - POMPA**  
 **ACCOUPLLEMENT MOTEUR- POMPE**  
 **ACOPLAMIENTO MOTOR - BOMBA**





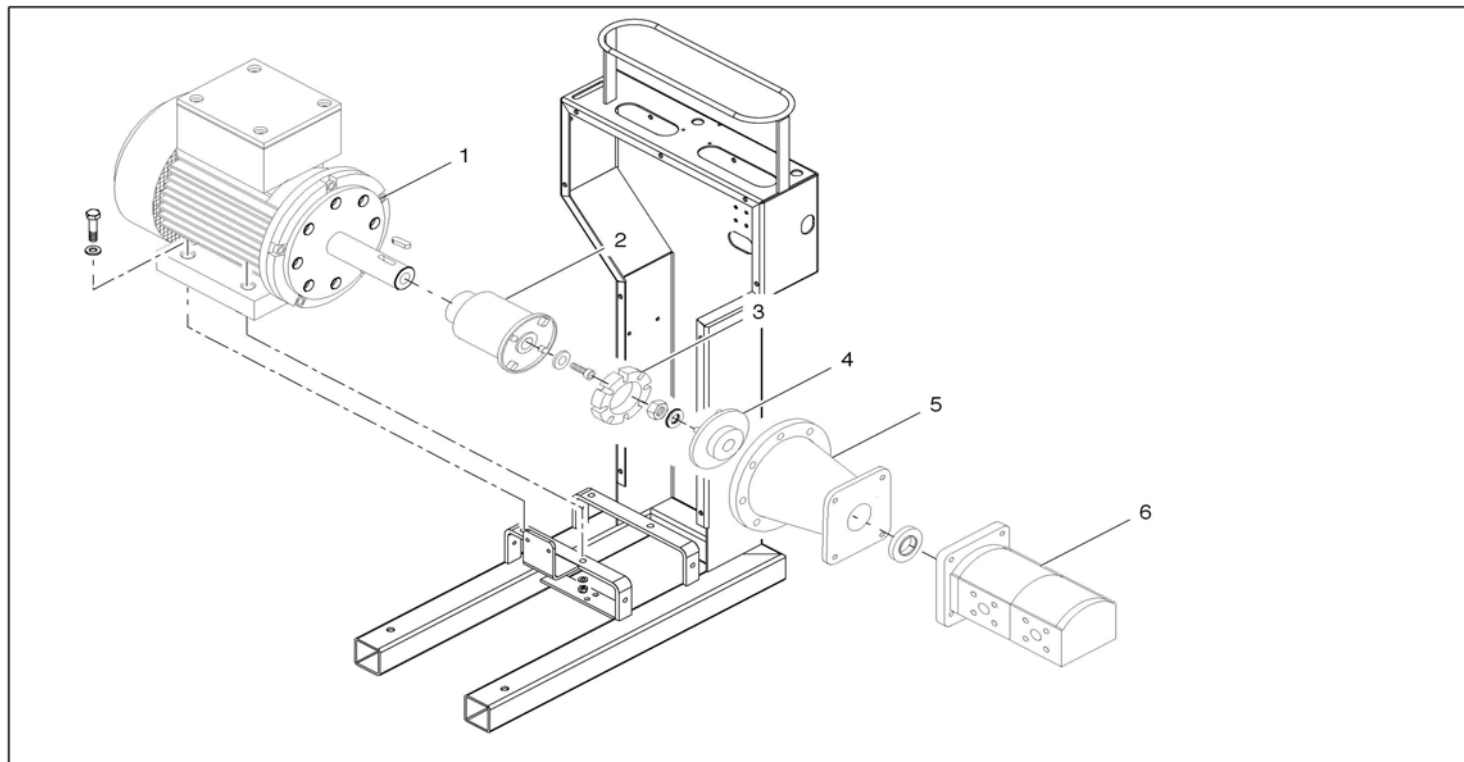

**ENGINE COUPLING - PUMP**   
**PUMPEN / MOTOR KUPPLUNG**   
**KOPPELING MOTOR - POMP** 



POS	Codice	Q.tà	 Descrizione	 Description	 Designation	 Benennung	 Descripción	 Beschrijving
01	25586300	1 NR	MOTORE DIESEL	DIESEL ENGINE	MOTEUR DIESEL	DIESELMOTOR	MOTOR DIESEL	DIESELMOTOR
02	2558630001	1 NR	ACCOPPIAMENTO MOTORE - POMPA	ENGINE COUPLING - PUMP	ACCOUPLLEMENT MOTEUR - POMPE	PUMPEN-/ MOTORKUP PLUNG	ACOPLAMIENTO MOTOR - BOMBA	KOPPELING MOTOR - POMP
03	05559100	1 NR	DISTANZIALE	SPACER	ENTRETOISE	DISTANZSTÜCK	DISTANCIADOR	AFSTANDSBLOK
04	25526300	1 NR	POMPA IDRAULICA	HYDRAULIC PUMP	POMPE HYDRAULIQUE	HYDRAULIKPUMPE	BOMBA HYDRAULICA	HYDRAULISCHE POMP
05	05480700	2 NR	PIASTRA	PLATE	PLATINE	PLATTE	PLACA	PLAAT
06	04152400	4 NR	ANTIVIBRANTE	ANTI- VIBRATING	ANTI - VIBRANT	VIBRATIONSDÄMPFER	ANTIVIBRANTE	ANTI- TRILELEMENT
07	14830300	1 NR	LEVA	LEVER	LEVIER	HEBEL	PALANCA	HENDEL
08	05550900	1 NR	CAVO ACCELERATORE	ACCELERATOR CABLE	CÂBLE ACCELERATEUR	BESCHLEUNIGUNGSK ABEL	CABLE ACELERADOR	VERSNELLINGSKABEL
09	2558630002	1 NR	CARTUCCIA FILTRO ARIA	AIR FILTER CARTRIDGE	CARTOUCHE FILTRE À AIR	LUFTFILTEREINSATZ	CARTUCHO FILTRO DE AIRE	PATROON LUCHTFILTER
10	2558630003	1 NR	FILTRO GASOLIO	GAS OIL FILTER	FILTRE À GASOIL	KRAFTSTOFFFILTER	FILTRO GASÓLEO	GASOLIEFILTER





 **MOTORE ELETTRICO**  
 **MOTEUR ÉLECTRIQUE**  
 **MOTOR ELÉCTRICO**

**ELECTRIC MOTOR**   
**E-MOTOR**   
**ELECTRICHE MOTOR** 

POS	Codice	Q.tà	 Descrizione	 Description	 Designation	 Benennung	 Descripcìon	 Beschrijving
01	25510100	1 NR	MOTORE ELETTRICO	ELECTRIC MOTOR	MOTEUR ÉLECTRIQUE	E-MOTOR	MOTOR ELÉCTRICO	ELECTRICHE MOTOR
02	05563400	1 NR	SEMIGIUNTO	HALF COUPLING	DEMI-JOINT	HALBVERBINDUNG	SEMI-ACOPLAMIENTO	HELFT KOPPELING
03	04310100	1 NR	INSERTO IN GOMMA	RUBBER INSERT	INSERT EN CAOUTCHOUC	GUMMIEINSATZ	INSERTO DE GOMA	RUBBER INZETSTUK
04	04615300	1 NR	GIUNTO	COUPLING	JOINT	VERBINDUNG	ACOPLAMIENTO	KOPPELING
05	05510200	1 NR	LANTERNA	LANTERN	LANTERNE	BUCHSE	LINTERNA	LANTAARN
06	25526300	1 NR	POMPA IDRAULICA	HYDRAULIC PUMP	POMPE HYDRAULIQUE	HYDRAULIKPUMPE	BOMBA HYDRAULICA	HYDRAULISCHE POMP





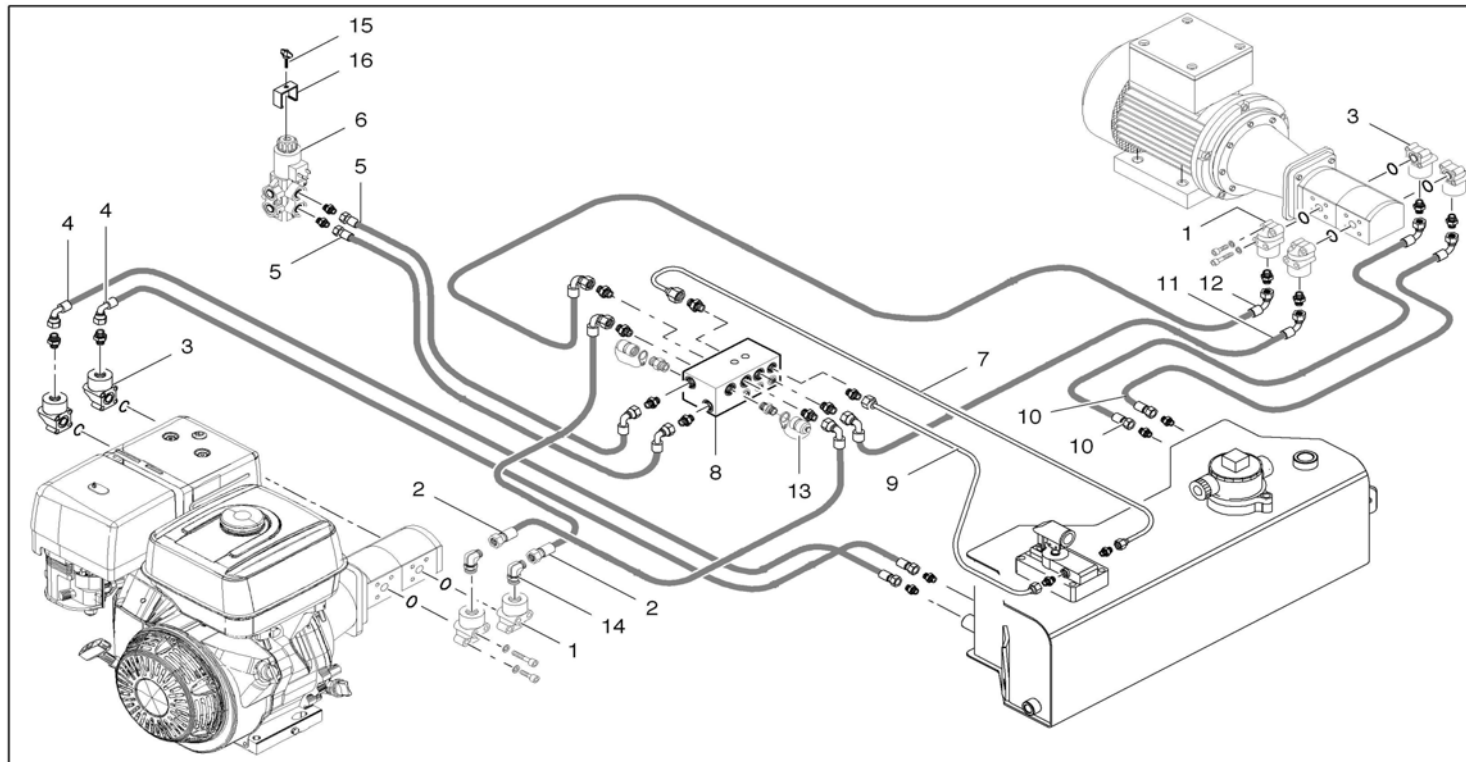

 **IMPIANTO IDRAULICO MANDATE E SCARICO**  
 **SYSTÈME HYDRAULIQUE REFOULEMENT ET DÉCHARGEMENT**  
 **INSTALACIÓN HIDRÁULICA IMPULSIONES Y DESCARGA**



**SUPPLY AND DISCHARGE HYDRAULIC SYSTEM**   
**HYDRAULIKANLAGE VORLÄUFE UND RÜCKLAUF**   
**HYDRAULISCHE INSTALLATIE UITSTROMINGEN EN ONTLADING** 





**IMPIANTO IDRAULICO MANDATE E SCARICO**  
**SYSTÈME HYDRAULIQUE REFOULEMENT ET**  
**DÉCHÈGEMENT**  
**INSTALACIÓN HIDRÁULICA IMPULSIONES Y**  
**DESCARGA**

**SUPPLY AND DISCHARGE HYDRAULIC SYSTEM**  
**HYDRAULIKANLAGE VORLÄUFE UND RÜCKLAUF**  
**HYDRAULISCHE INSTALLATIE UITSTROMINGEN EN**  
**ONTLADING**

POS	Codice	Q.tà	 Descrizione	 Description	 Designation	 Benennung	 Descripción	 Beschrijving
01	04048100	2 NR	FLANGIA	FLANGE	BRIDE	FLANSCH	BRIDA	FLENS
01	04048100	2 NR	FLANGIA	FLANGE	BRIDE	FLANSCH	BRIDA	FLENS
02	05540800	2 NR	TUBO FLESSIBILE	FLEXIBLE PIPE	TUYAU FLEXIBLE	SCHLAUCH	TUBO FLEXIBILE	BUIGZAME LEIDING
03	04845400	2 NR	FLANGIA	FLANGE	BRIDE	FLANSCH	BRIDA	FLENS
03	04845400	2 NR	FLANGIA	FLANGE	BRIDE	FLANSCH	BRIDA	FLENS
04	05612800	2 NR	TUBO FLESSIBILE	FLEXIBLE PIPE	TUYAU FLEXIBLE	SCHLAUCH	TUBO FLEXIBILE	BUIGZAME LEIDING
05	05540900	2 NR	TUBO FLESSIBILE	FLEXIBLE PIPE	TUYAU FLEXIBLE	SCHLAUCH	TUBO FLEXIBILE	BUIGZAME LEIDING
06	15509100	1 NR	DEVIATORE	SWITCH	DÉVIATEUR	WECHSELSCHALTER	DESVIADOR	OMSCHAKELAAR
07	05551900	1 NR	TUBO RIGIDO	RIGID PIPE	TUYAU RIGIDE	ROHR	TUBO RÍGIDO	OMBUIGZAME LEIDING
08	15496200	1 NR	VALVOLA IDRAULICA	HYDRAULIC VALVE	VALVE HYDRAULIQUE	VALVE HYDRAULIQUE	VÁLVULA HIDRÁULICA	HYDRAULISCHE KLEP
09	05552000	1 NR	TUBO RIGIDO	RIGID PIPE	TUYAU RIGIDE	ROHR	TUBO RÍGIDO	OMBUIGZAME LEIDING
10	05540700	2 NR	TUBO FLESSIBILE	FLEXIBLE PIPE	TUYAU FLEXIBLE	SCHLAUCH	TUBO FLEXIBILE	BUIGZAME LEIDING
11	05540500	1 NR	TUBO FLESSIBILE	FLEXIBLE PIPE	TUYAU FLEXIBLE	SCHLAUCH	TUBO FLEXIBILE	BUIGZAME LEIDING
12	05540400	1 NR	TUBO FLESSIBILE	FLEXIBLE PIPE	TUYAU FLEXIBLE	SCHLAUCH	TUBO FLEXIBILE	BUIGZAME LEIDING
13	03014400	2 NR	PROVA PRESSIONE	PRESSURE TEST	PREUVE PRESSION	DRUCKKONTROLLE	PRUEBA PRESIÓN	DRUKTEST
14	04995000	5 NR	RACCORDO	FITTING	RACCORD	ANSCHLUSS	CONEXIÓN	VERBINDING
15	05628800	1 NR	GALLETTO	WING NUT	ECROU PAPILLON	FLÜGELMUTTER	TUERCA DE MARIPOSA	VLEUGELMOER



 **IMPIANTO IDRAULICO MANDATE E SCARICO**  
 **SYSTÈME HYDRAULIQUE REFOULEMENT ET DÉCHARGEMENT**  
 **INSTALACIÓN HIDRÁULICA IMPULSIONES Y DESCARGA**



**SUPPLY AND DISCHARGE HYDRAULIC SYSTEM**   
**HYDRAULIKANLAGE VORLÄUFE UND RÜCKLAUF**   
**HYDRAULISCHE INSTALLATIE UITSTROMINGEN EN ONTLADING** 

POS	Codice	Q.tà	 Descrizione	 Description	 Designation	 Benennung	 Descripción	 Beschrijving
16	05618800	1 NR	COMANDO IDRAULICO	HYDRAULIC CONTROL	COMMANDE HYDRAULIQUE	HYDRAULISCHER ANTRIEB	COMANDO HIDRÁULICO	HYDRAULISCHE BEDIENING









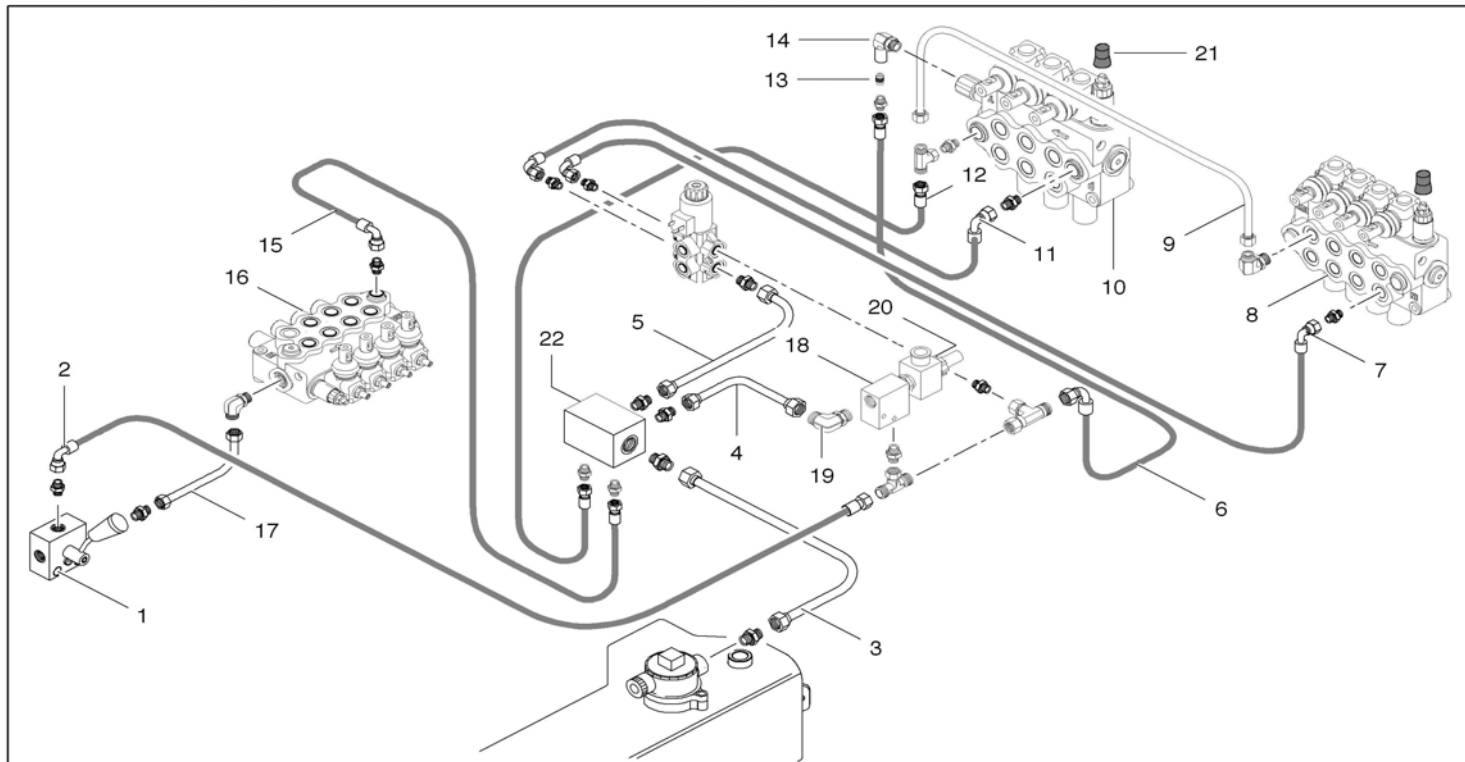







 **IMPIANTO IDRAULICO MANDATE E SCARICO**  
 **SYSTÈME HYDRAULIQUE REFOULEMENT ET DÉCHARGEMENT**  
 **INSTALACIÓN HIDRÁULICA IMPULSIONES Y DESCARGA**



**SUPPLY AND DISCHARGE HYDRAULIC SYSTEM**   
**HYDRAULIKANLAGE VORLÄUFE UND RÜCKLAUF**   
**HYDRAULISCHE INSTALLATIE UITSTROMINGEN EN ONTLADING** 











 **IMPIANTO IDRAULICO MANDATE E SCARICO**  
 **SYSTÈME HYDRAULIQUE REFOULEMENT ET DÉCHÈGEMENT**  
 **INSTALACIÓN HIDRÁULICA IMPULSIONES Y DESCARGA**

**SUPPLY AND DISCHARGE HYDRAULIC SYSTEM**   
**HYDRAULIKANLAGE VORLÄUFE UND RÜCKLAUF**   
**HYDRAULISCHE INSTALLATIE UITSTROMINGEN EN ONTLADING** 

POS	Codice	Q.tà	 Descrizione	 Description	 Designation	 Benennung	 Descripción	 Beschrijving
01	14419100	1 NR	DEVIATORE	SWITCH	DÉVIATEUR	WECHSELSCHALTER	DESVIADOR	OMSCHAKELAAR
02	05542800	1 NR	TUBO FLESSIBILE	FLEXIBLE PIPE	TUYAU FLEXIBLE	SCHLAUCH	TUBO FLEXIBLE	BUIGZAME LEIDING
03	05551800	1 NR	TUBO RIGIDO	RIGID PIPE	TUYAU RIGIDE	ROHR	TUBO RÍGIDO	OMBUIGZAME LEIDING
04	05551400	1 NR	TUBO RIGIDO	RIGID PIPE	TUYAU RIGIDE	ROHR	TUBO RÍGIDO	OMBUIGZAME LEIDING
05	05551500	1 NR	TUBO RIGIDO	RIGID PIPE	TUYAU RIGIDE	ROHR	TUBO RÍGIDO	OMBUIGZAME LEIDING
06	05542000	1 NR	TUBO FLESSIBILE	FLEXIBLE PIPE	TUYAU FLEXIBLE	SCHLAUCH	TUBO FLEXIBLE	BUIGZAME LEIDING
07	05541900	1 NR	TUBO FLESSIBILE	FLEXIBLE PIPE	TUYAU FLEXIBLE	SCHLAUCH	TUBO FLEXIBLE	BUIGZAME LEIDING
08	25509500	1 NR	DISTRIBUTORE IDRAULICO	HYDRAULIC DISTRIBUTOR	DISTRIBUTEUR HYDRAULIQUE	HYDR. REGELSTEUERGERÄT	DISTRIBUIDOR HIDRÁULICO	HYDRAULISCHE VERDELER
09	05551600	1 NR	TUBO RIGIDO	RIGID PIPE	TUYAU RIGIDE	ROHR	TUBO RÍGIDO	OMBUIGZAME LEIDING
10	25509600	1 NR	DISTRIBUTORE IDRAULICO	HYDRAULIC DISTRIBUTOR	DISTRIBUTEUR HYDRAULIQUE	HYDR. REGELSTEUERGERÄT	DISTRIBUIDOR HIDRÁULICO	HYDRAULISCHE VERDELER
11	05541800	1 NR	TUBO FLESSIBILE	FLEXIBLE PIPE	TUYAU FLEXIBLE	SCHLAUCH	TUBO FLEXIBLE	BUIGZAME LEIDING
12	05542200	1 NR	TUBO FLESSIBILE	FLEXIBLE PIPE	TUYAU FLEXIBLE	SCHLAUCH	TUBO FLEXIBLE	BUIGZAME LEIDING
13	05509400	1 NR	CARTUCCIA OLIO IDR.	HYDR. OIL CARTRIDGE	CARTOUCHE HUILE HYDR.	HYDRAULIKÖLEINSA TZ	CARTUCHO ACEITE IDR.	PATROON HYDR. OLIE
14	05507300	1 NR	RACCORDO	FITTING	RACCORD	ANSCHLUSS	CONEXIÓN	VERBINDING
15	05542700	1 NR	TUBO FLESSIBILE	FLEXIBLE PIPE	TUYAU FLEXIBLE	SCHLAUCH	TUBO FLEXIBLE	BUIGZAME LEIDING

 **IMPIANTO IDRAULICO MANDATE E SCARICO**  
 **SYSTÈME HYDRAULIQUE REFOULEMENT ET DÉCHARGEMENT**  
 **INSTALACIÓN HIDRÁULICA IMPULSIONES Y DESCARGA**

**SUPPLY AND DISCHARGE HYDRAULIC SYSTEM**   
**HYDRAULIKANLAGE VORLÄUFE UND RÜCKLAUF**   
**HYDRAULISCHE INSTALLATIE UITSTROMINGEN EN ONTLADING** 







POS	Codice	Q.tà	 Descrizione	 Description	 Designation	 Benennung	 Descripción	 Beschrijving
16	25509700	1 NR	DISTRIBUTORE IDRAULICO	HYDRAULIC DISTRIBUTOR	DISTRIBUTEUR HYDRAULIQUE	HYDR. REGELSTEUERGERÄT	DISTRIBUIDOR HIDRÁULICO	HYDRAULISCHE VERDELER
17	05551300	1 NR	TUBO RIGIDO	RIGID PIPE	TUYAU RIGIDE	ROHR	TUBO RÍGIDO	OMBUIGZAME LEIDING
18	25509000	1 NR	ELETTRIVALVOLA	SOLENOID VALVE	ÉLECTROVANNE	MAGNETVENTIL	ELECTROVÁLVULA	ELEKTROKLEP
19	04995000	1 NR	RACCORDO	FITTING	RACCORD	ANSCHLUSS	CONEXIÓN	VERBINDING
20	0552550002	1 NR	BOBINA	COIL	BOBINE	SPULE	BOBINA	SPOEL
21	05576200	24 NR	PROTEZIONE	PROTECTION	PROTECTION	SCHUTZ	PROTECCIÓN	BESCHERMING
22	05497500	1 NR	BLOCCHETTO TUBI	HOSES BLOCK	BLOC TUYAUX	ROHRBLOCK	BLOQUE TUBOS	LEIDINGENBLOKJE

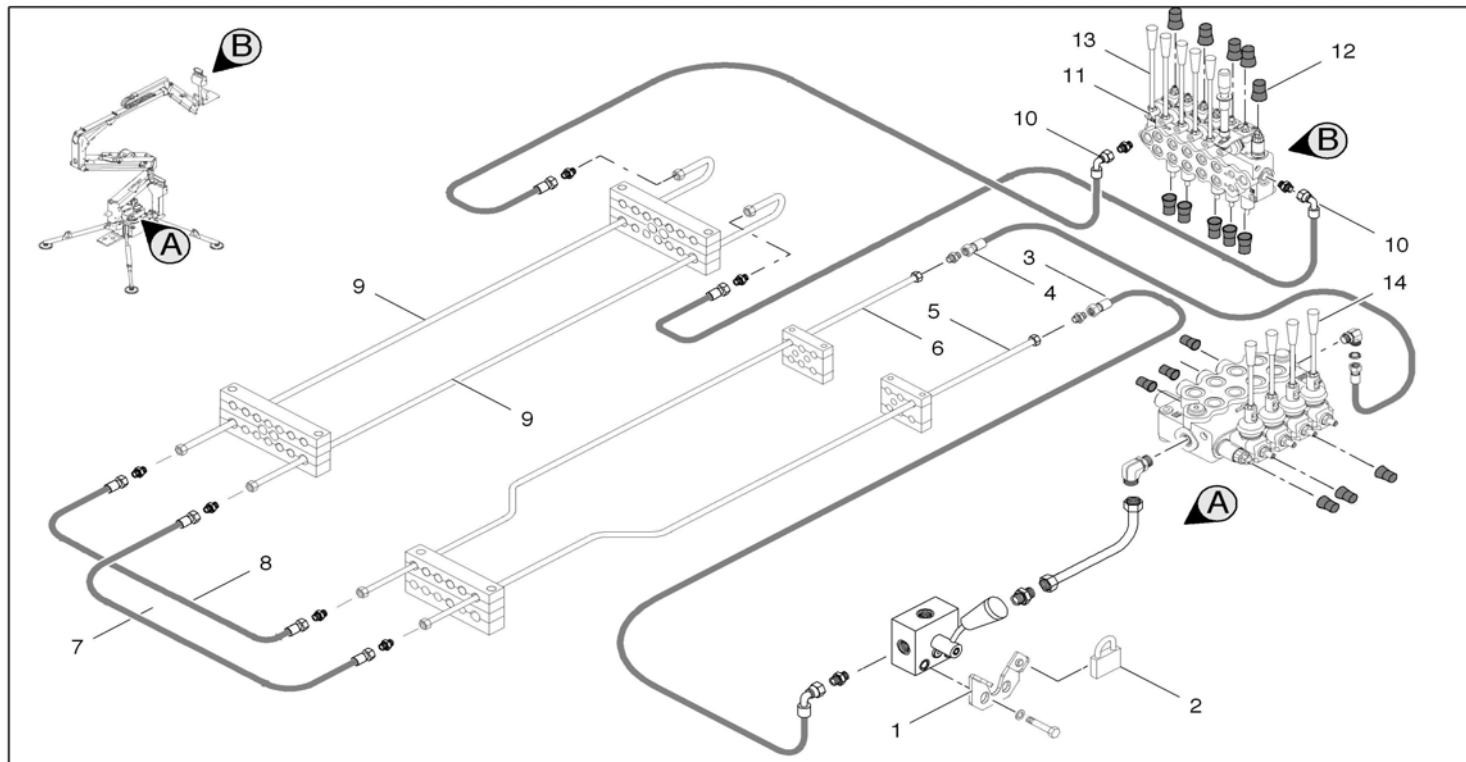

 **IMPIANTO IDRAULICO DEVIATORE**  
 **INSTALLATION HYDRAULIQUE DEVIATEUR**  
 **INSTALACIÓN HIDRÁULICA DESVIADOR**







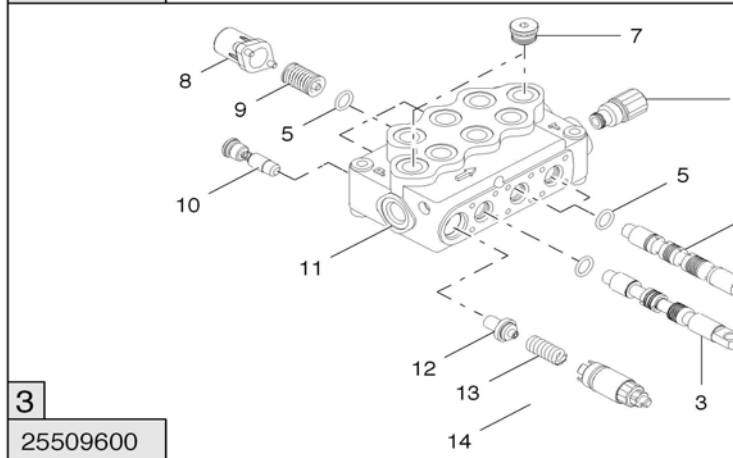
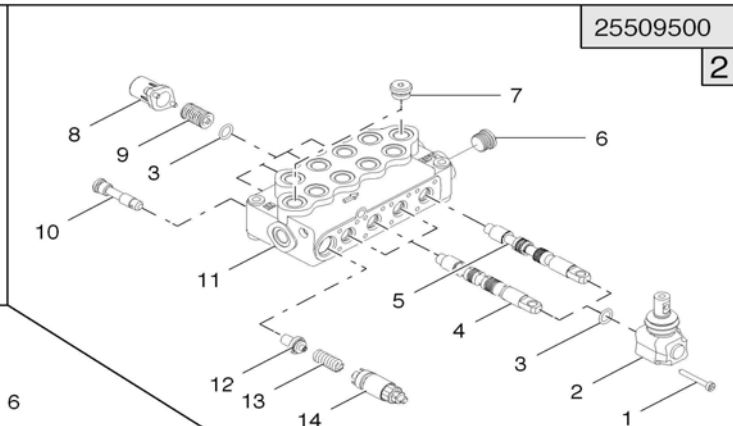
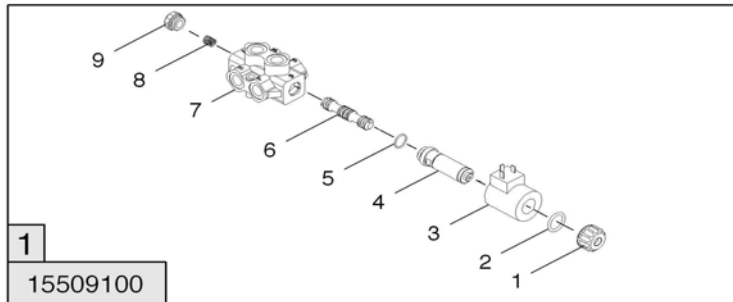





**REVERSING VALVE HYDRAULIC SYSTEM**   
**HYDRAULIKKREIS DES UMSTEUERVENTILS**   
**HYDRAULISCHE INSTALLATIE OMLEIDER** 













 <b>IMPIANTO IDRAULICO DEVIATORE</b>  <b>INSTALLATION HYDRAULIQUE DEVIATEUR</b>  <b>INSTALACIÓN HIDRÁULICA DESVIADOR</b>				<b>REVERSING VALVE HYDRAULIC SYSTEM</b>  <b>HYDRAULIKKREIS DES UMSTEUERVENTILS</b>  <b>HYDRAULISCHE INSTALLATIE OMLEIDER</b> 				
POS	Codice	Q.tà	 Descrizione	 Description	 Designation	 Benennung	 Descripcìon	 Beschrijving
01	05570000	1 NR	LAMIERA PIEGATA	FOLDED PLATE	TÔLE PLIÉE	BLECH GEBOGEN	CHAPA DOBLADA	PLAATIJZER GEBOGEN
02	05609800	1 NR	LUCCHETTO	PADLOCK	CADENAS	VORHÄNGESCHLOSS	CANDADO	HANGSLOT
03	05542900	1 NR	TUBO FLESSIBILE	FLEXIBLE PIPE	TUYAU FLEXIBLE	SCHLAUCH	TUBO FLEXIBLE	BUIGZAME LEIDING
04	05543000	1 NR	TUBO FLESSIBILE	FLEXIBLE PIPE	TUYAU FLEXIBLE	SCHLAUCH	TUBO FLEXIBLE	BUIGZAME LEIDING
05	05552100	1 NR	TUBO RIGIDO	RIGID PIPE	TUYAU RIGIDE	ROHR	TUBO RÍGIDO	OMBUIGZAME LEIDING
06	05552200	1 NR	TUBO RIGIDO	RIGID PIPE	TUYAU RIGIDE	ROHR	TUBO RÍGIDO	OMBUIGZAME LEIDING
07	05544700	1 NR	TUBO RIGIDO	RIGID PIPE	TUYAU RIGIDE	ROHR	TUBO RÍGIDO	OMBUIGZAME LEIDING
08	05544600	1 NR	TUBO FLESSIBILE	FLEXIBLE PIPE	TUYAU FLEXIBLE	SCHLAUCH	TUBO FLEXIBLE	BUIGZAME LEIDING
09	05552300	2 NR	TUBO RIGIDO	RIGID PIPE	TUYAU RIGIDE	ROHR	TUBO RÍGIDO	OMBUIGZAME LEIDING
10	05545900	2 NR	TUBO FLESSIBILE	FLEXIBLE PIPE	TUYAU FLEXIBLE	SCHLAUCH	TUBO FLEXIBLE	BUIGZAME LEIDING
11	25526000	1 NR	DISTRIBUTORE IDRAULICO	HYDRAULIC DISTRIBUTOR	DISTRIBUTEUR HYDRAULIQUE	HYDR. REGELSTEUERGERÄT	DISTRIBUIDOR HIDRÁULICO	HYDRAULISCHE VERDELER
12	05576200	16 NR	PROTEZIONE	PROTECTION	PROTECTION	SCHUTZ	PROTECCIÓN	BESCHERMING
13	05645400	5 NR	ASTA	ROD	TIGE	STANGE	VARILLA	STANG
14	05645600	4 NR	ASTA	ROD	TIGE	STANGE	VARILLA	STANG





 <b>DISTRIBUTORI IDRAULICI</b>  <b>DISTRIBUTEURS HYDRAULIQUES</b>  <b>DISTRIBUIDORES HIDRÁULICOS</b>			<b>HYDRAULIC DISTRIBUTORS</b>  <b>HYDRAULISCHE REGELSTEUERGERÄTE</b>  <b>HYDRAULISCHE VERDELERS</b> 					
POS	Codice	Q.tà	 Descrizione	 Description	 Designation	 Benennung	 Descripción	 Beschrijving
01	01 1550910001	1 NR	GHIERA	NUT	BAGUE	NUTMUTTER	ANILLO	RINGMOER
01	02 1550910002	1 NR	O-RING	O-RING	O-RING	O-RING	O-RING	O-RING
01	03 1550910003	1 NR	BOBINA	COIL	BOBINE	SPULE	BOBINA	SPOEL
01	04 1550910004	1 NR	COLLETTORE	MANIFOLD	COLLECTEUR	KOLLEKTOR	COLECTOR	COLLECTOR
01	05 1550910005	1 NR	O-RING	O-RING	O-RING	O-RING	O-RING	O-RING
01	06 1550910006	1 NR	CURSORE	CURSOR	CURSEUR	CURSOR	CURSOR	SCHUIF
01	07 1550910007	1 NR	CORPO	BODY	CORPS	GEHÄUSE	CUERPO	HOOFDDEEL
01	08 1550910008	1 NR	MOLLA	SPRING	RESSORT	FEDER	MUELLE	VEER
01	09 1550910009	1 NR	TAPPO	CAP	BOUCHON	VERSCHLUSS	TAPÓN	DOP
02	01 2550950001	8 NR	VITE	SCREW	VIS	SCHRAUBE	TORNILLO	SCHROEF
02	02 2550950002	4 NR	LEVA	LEVER	LEVIER	HEBEL	PALANCA	HENDE
02	03 2550950003	8 NR	O-RING	O-RING	O-RING	O-RING	O-RING	O-RING
02	04 2550950004	3 NR	CURSORE	CURSOR	CURSEUR	CURSOR	CURSOR	SCHUIF
02	05 2550950005	1 NR	CURSORE	CURSOR	CURSEUR	CURSOR	CURSOR	SCHUIF
02	06 2550950006	1 NR	TAPPO	CAP	BOUCHON	VERSCHLUSS	TAPÓN	DOP
02	07 2550950007	2 NR	TAPPO	CAP	BOUCHON	VERSCHLUSS	TAPÓN	DOP
02	08 2550950008	4 NR	KIT CAPPELLOTTO	CAP KIT	KIT BOUCHON FILETÉ	ABSCHLUSSKAPPENS ATZ	KIT TAPÓN ROSCADO	KIT KAPJE

 <b>DISTRIBUTORI IDRAULICI</b>  <b>DISTRIBUTEURS HYDRAULIQUES</b>  <b>DISTRIBUIDORES HIDRÁULICOS</b>			<b>HYDRAULIC DISTRIBUTORS</b>  <b>HYDRAULISCHE REGELSTEUERGERÄTE</b>  <b>HYDRAULISCHE VERDELERS</b> 					
POS	Codice	Q.tà	 Descrizione	 Description	 Designation	 Benennung	 Descripción	 Beschrijving
02 09	2550950009	4 NR	KIT MOLLA	SPRING KIT	KIT RESSORT	FEDERSATZ	KIT MUELLE	KIT VEER
02 10	2550950010	1 NR	KIT VR5	KIT VR5	KIT VR5	KIT VR5	KIT VR5	KIT VR5
02 11	2550950011	1 NR	CORPO	BODY	CORPS	GEHÄUSE	CUERPO	HOOFDDEEL
02 12	2550950012	1 NR	REGISTRO	REGISTER	REGISTRE	REGISTER	REGULADOR	REGISTER
02 13	2550950013	1 NR	MOLLA	SPRING	RESSORT	RESSORT	MUELLE	VEER
02 14	2550950014	1 NR	PORTAMOLLA	SPRING SUPPORT	SUPPORT RESSORT	FEDERHALTER	PORTAMUELLE	VEERHOUDER
03 01	2550960001	6 NR	VITE	SCREW	VIS	SCHRAUBE	TORNILLO	SCHROEF
03 02	2550960002	3 NR	LEVA	LEVER	LEVIER	HEBEL	PALANCA	HENDEL
03 03	2550960003	1 NR	CURSORE	CURSOR	CURSEUR	CURSOR	CURSOR	SCHUIF
03 04	2550960004	2 NR	CURSORE	CURSOR	CURSEUR	CURSOR	CURSOR	SCHUIF
03 05	2550960005	6 NR	O-RING	O-RING	O-RING	O-RING	O-RING	O-RING
03 06	2550960006	1 NR	GIUNZIONE	JOINT	JOINT	VERBINDUNGSSTÜCK	UNIÓN	KOPPELING
03 07	2550960007	2 NR	TAPPO	CAP	BOUCHON	VERSCHLUSS	TAPÓN	DOP
03 08	2550960008	3 NR	KIT CAPPELLOTTO	CAP KIT	KIT BOUCHON FILETÉ	ABSCHLUSSKAPPENS ATZ	KIT TAPÓN ROSCADO	KIT KAPJE
03 09	2550960009	3 NR	KIT MOLLA	SPRING KIT	KIT RESSORT	FEDERSATZ	KIT MUELLE	KIT VEER
03 10	2550960010	1 NR	KIT VR5	KIT VR5	KIT VR5	KIT VR5	KIT VR5	KIT VR5
03 12	2550960011	1 NR	CORPO	BODY	CORPS	GEHÄUSE	CUERPO	HOOFDDEEL

 **DISTRIBUTORI IDRAULICI**  
 **DISTRIBUTEURS HYDRAULIQUES**  
 **DISTRIBUIDORES HIDRÁULICOS**

**HYDRAULIC DISTRIBUTORS**   
**HYDRAULISCHE REGELSTEUERGERÄTE**   
**HYDRAULISCHE VERDELERS** 

POS	Codice	Q.tà	 Descrizione	 Description	 Designation	 Benennung	 Descripción	 Beschrijving
03 12	2550960012	1 NR	REGISTRO	REGISTER	REGISTRE	REGISTER	REGULADOR	REGISTER
03 13	2550960013	1 NR	MOLLA	SPRING	RESSORT	FEDER	MUELLE	VEER
03 14	2550960014	1 NR	PORTAMOLLA	SPRING SUPPORT	SUPPORT RESSORT	FEDERHALTER	PORTAMUELLE	VEERHOUDER





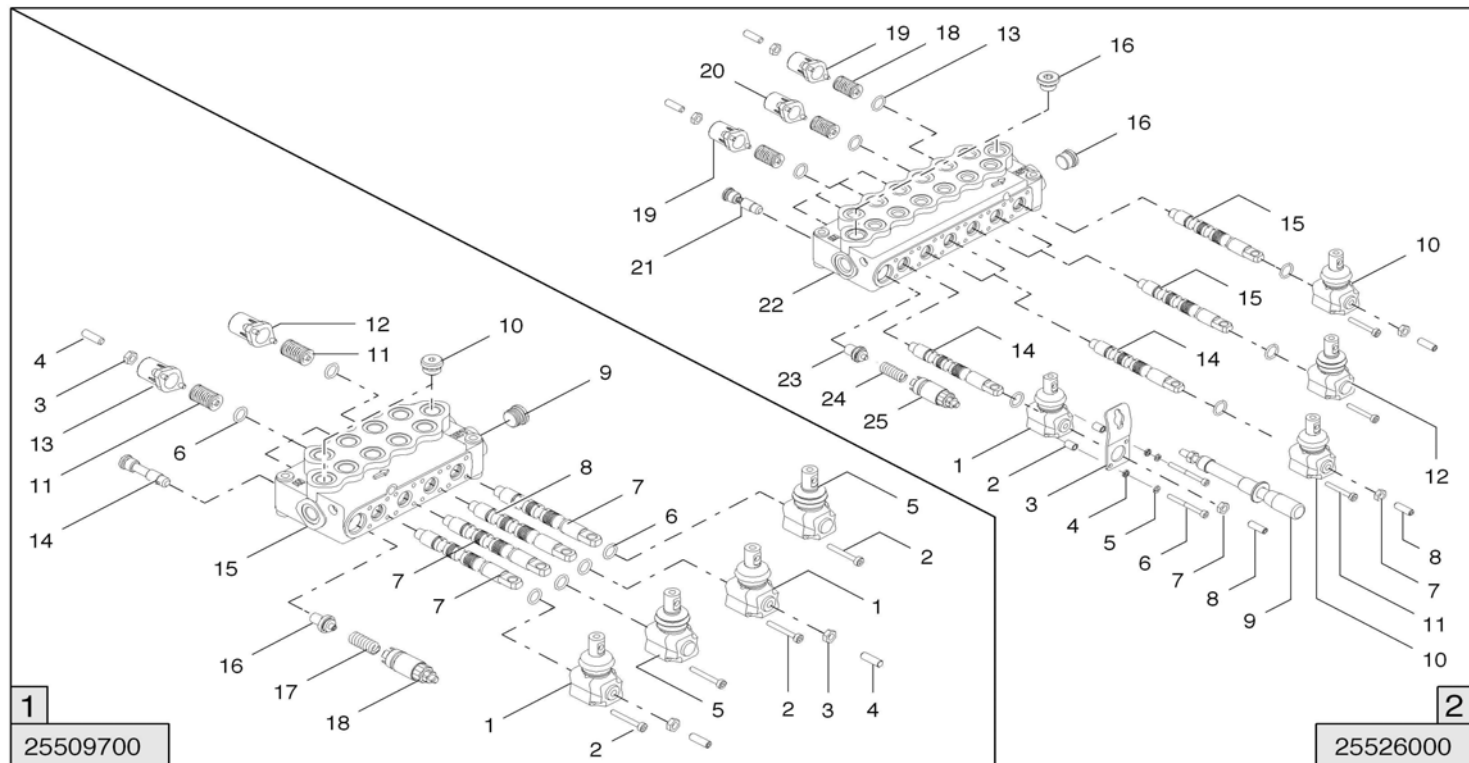

 **DISTRIBUTORI IDRAULICI**  
 **DISTRIBUTEURS HYDRAULIQUES**  
 **DISTRIBUIDORES HIDRÁULICOS**

**HYDRAULIC DISTRIBUTORS**   
**HYDRAULISCHE REGELSTEUERGERÄTE**   
**HYDRAULISCHE VERDEELERS** 



 <b>DISTRIBUTORI IDRAULICI</b>  <b>DISTRIBUTEURS HYDRAULIQUES</b>  <b>DISTRIBUIDORES HIDRÁULICOS</b>			<b>HYDRAULIC DISTRIBUTORS</b>  <b>HYDRAULISCHE REGELSTEUERGERÄTE</b>  <b>HYDRAULISCHE VERDELERS</b> 					
POS	Codice	Q.tà	 Descrizione	 Description	 Designation	 Benennung	 Descripción	 Beschrijving
01 01	2550970001	2 NR	KIT LEVA	LEVER KIT	KIT LEVIER	HEBELSATZ	KIT PALANCA	KIT HENDEL
01 02	2550970002	8 NR	VITE	SCREW	VIS	SCHRAUBE	TORNILLO	SCHROEF
01 03	2550970003	5 NR	DADO	NUT	ÉCROU	MUTTER	TUERCA	MOER
01 04	2550970004	5 NR	VITE	SCREW	VIS	SCHRAUBE	TORNILLO	SCHROEF
01 05	2550970005	2 NR	LEVA	LEVER	LEVIER	HEBEL	PALANCA	HENDEL
01 06	2550970006	8 NR	O-RING	O-RING	O-RING	O-RING	O-RING	O-RING
01 07	2550970007	3 NR	CURSORE	CURSOR	CURSEUR	CURSOR	CURSOR	SCHUIF
01 08	2550970008	1 NR	CURSORE	CURSOR	CURSEUR	CURSOR	CURSOR	SCHUIF
01 09	2550970009	2 NR	TAPPO	CAP	BOUCHON	VERSCHLUSS	TAPÓN	DOP
01 10	2550970010	2 NR	TAPPO	CAP	BOUCHON	VERSCHLUSS	TAPÓN	DOP
01 11	2550970011	4 NR	KIT MOLLA	SPRING KIT	KIT RESSORT	FEDERSATZ	KIT MUELLE	KIT VEER
01 12	2550970012	1 NR	KIT CAPPELLOTTO	CAP KIT	KIT BOUCHON FILETÉ	ABSCHLUSSKAPPENS ATZ	KIT TAPÓN ROSCADO	KIT KAPJE
01 13	2550970013	2 NR	KIT CAPPELLOTTO	CAP KIT	KIT BOUCHON FILETÉ	ABSCHLUSSKAPPENS ATZ	KIT TAPÓN ROSCADO	KIT KAPJE
01 14	2550970014	1 NR	KIT VR5	KIT VR5	KIT VR5	KIT VR5	KIT VR5	KIT VR5
01 15	2550970015	1 NR	CORPO	BODY	CORPS	GEHÄUSE	CUERPO	HOOFDDEEL
01 16	2550970016	1 NR	REGISTRO	REGISTER	REGISTRE	REGISTER	REGULADOR	REGISTER
01 17	2550970017	1 NR	MOLLA	SPRING	RESSORT	FEDER	MUELLE	VEER

 <b>DISTRIBUTORI IDRAULICI</b>  <b>DISTRIBUTEURS HYDRAULIQUES</b>  <b>DISTRIBUIDORES HIDRÁULICOS</b>			<b>HYDRAULIC DISTRIBUTORS</b>  <b>HYDRAULISCHE REGELSTEUERGERÄTE</b>  <b>HYDRAULISCHE VERDELERS</b> 					
POS	Codice	Q.tà	 Descrizione	 Description	 Designation	 Benennung	 Descripcìon	 Beschrijving
01 18	2550970018	1 NR	PORTAMOLLA	SPRING SUPPORT	SUPPORT RESSORT	FEDERHALTER	PORTAMUELLE	VEERHOUDER
02 01	2552600001	1 NR	LEVA	LEVER	LEVIER	HEBEL	PALANCA	HENDEL
02 02	2552600002	2 NR	ANELLO	RING	ANEL	RING	ANILLO	RING
02 03	2552600003	1 NR	STAFFA	BRACKET	ÉTRIER	HALTEBÜGEL	HALTEBÜGEL	BEUGEL
02 04	2552600004	2 NR	ANELLO	RING	BAGUE	RING	ANILLO	RING
02 05	2552600005	2 NR	RONDELLA	WASHER	RONDELLE	UNTERLEGSCHIEBE	ARANDELA	SLUITRING
02 06	2552600006	2 NR	VITE	SCREW	VIS	SCHRAUBE	TORNILLO	SCHROEF
02 07	2552600007	7 NR	VITE	SCREW	VIS	SCHRAUBE	TORNILLO	SCHROEF
02 08	2552600008	7 NR	VITE	SCREW	VIS	SCHRAUBE	TORNILLO	SCHROEF
02 09	2552600009	1 NR	ASTA	ROD	TIGE	STANGE	VARILLA	STANG
02 10	2552600010	2 NR	LEVA	LEVER	LEVIER	HEBEL	PALANCA	HENDEL
02 11	2552600011	8 NR	VITE	SCREW	VIS	SCHRAUBE	TORNILLO	SCHROEF
02 12	2552600012	2 NR	LEVA	LEVER	LEVIER	HEBEL	PALANCA	HENDEL
02 13	2552600013	12 NR	O-RING	O-RING	O-RING	O-RING	O-RING	O-RING
02 14	2552600014	3 NR	CURSORE	CURSOR	CURSEUR	CURSOR	CURSOR	SCHUIF
02 15	2552600015	3 NR	CURSORE	CURSOR	CURSEUR	CURSOR	CURSOR	SCHUIF
02 16	2552600016	1 NR	TAPPO	CAP	BOUCHON	VERSCHLUSS	TAPÓN	DOP



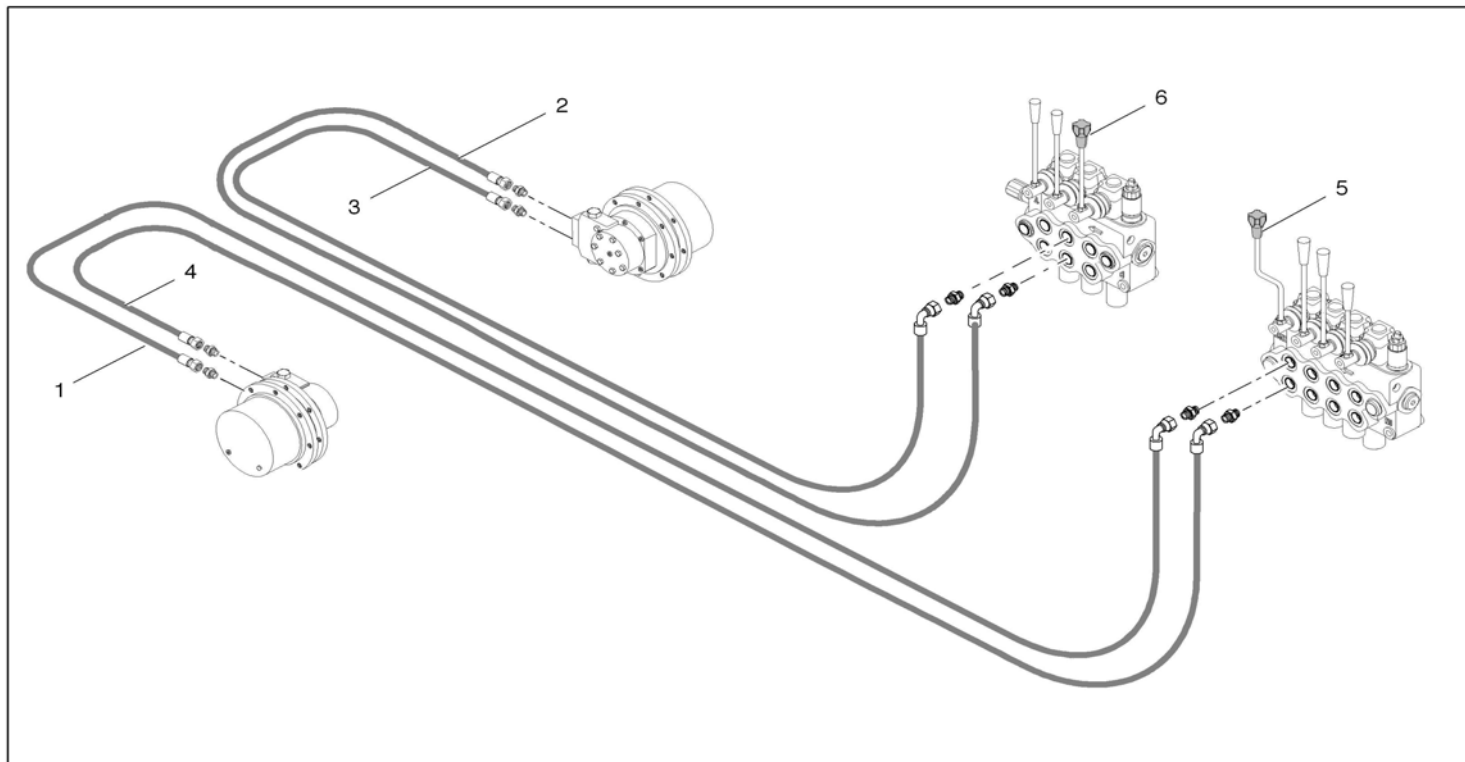



 <b>DISTRIBUTORI IDRAULICI</b>  <b>DISTRIBUTEURS HYDRAULIQUES</b>  <b>DISTRIBUIDORES HIDRÁULICOS</b>			<b>HYDRAULIC DISTRIBUTORS</b>  <b>HYDRAULISCHE REGELSTEUERGERÄTE</b>  <b>HYDRAULISCHE VERDELERS</b> 					
POS	Codice	Q.tà	 Descrizione	 Description	 Designation	 Benennung	 Descripción	 Beschrijving
02 17	2552600017	2 NR	TAPPO	CAP	BOUCHON	VERSCHLUSS	TAPÓN	DOP
02 18	2552600018	5 NR	KIT MOLLA	SPRING KIT	KIT RESSORT	FEDERSATZ	KIT MUELLE	KIT VEER
02 19	2552600019	4 NR	KIT CAPPELOTTO	CAP KIT	KIT BOUCHON FILETÉ	ABSCHLUSSKAPPENS ATZ	KIT TAPÓN ROSCADO	KIT KAPJE
02 20	2552600020	1 NR	KIT CAPPELOTTO	CAP KIT	KIT BOUCHON FILETÉ	ABSCHLUSSKAPPENS ATZ	KIT TAPÓN ROSCADO	KIT KAPJE
02 21	2552600021	1 NR	KIT VR5	KIT VR5	KIT VR5	KIT VR5	KIT VR5	KIT VR5
02 22	2552600022	1 NR	CORPO	BODY	CORPS	GEHÄUSE	CUERPO	HOOFDDEEL
02 23	2552600023	1 NR	REGISTRO	REGISTER	REGISTRE	REGISTER	REGULADOR	REGISTER
02 24	2552600024	1 NR	MOLLA	SPRING	RESSORT	FEDER	MUELLE	VEER
02 25	2552600025	1 NR	PORTAMOLLA	SPRING SUPPORT	SUPPORT RESSORT	FEDERHALTER	PORTAMUELLE	VEERHOUDER





 **IMPIANTO IDRAULICO TRAZIONE**  
 **SYSTÈME HYDRAULIQUE DE TRACTION**  
 **INSTALACIÓN HIDRÁULICA TRACCIÓN**









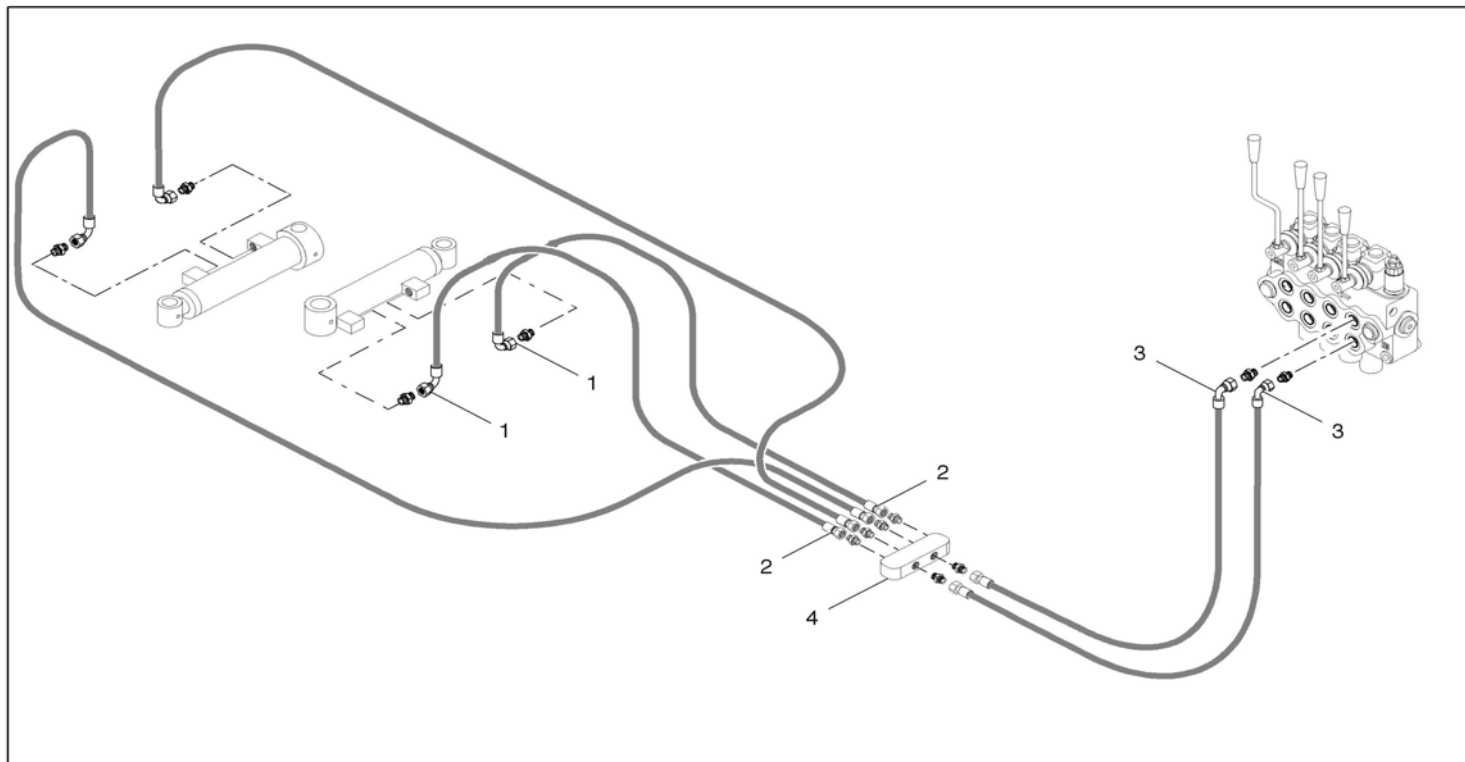



**HYDRAULIC SYSTEM FOR TRACTION**   
**HYDRAULIKANLAGE ANTRIEB**   
**HYDRAULISCHE AANDRIJFINSTALLATIE** 

POS	Codice	Q.tà	 Descrizione	 Description	 Designation	 Benennung	 Descripcìon	 Beschrijving
01	05542600	1 NR	TUBO FLESSIBILE	FLEXIBLE PIPE	TUYAU FLEXIBLE	SCHLAUCH	TUBO FLEXIBLE	BUIGZAME LEIDING
02	05542300	1 NR	TUBO FLESSIBILE	FLEXIBLE PIPE	TUYAU FLEXIBLE	SCHLAUCH	TUBO FLEXIBLE	BUIGZAME LEIDING
03	05542400	1 NR	TUBO FLESSIBILE	FLEXIBLE PIPE	TUYAU FLEXIBLE	SCHLAUCH	TUBO FLEXIBLE	BUIGZAME LEIDING
04	05542500	1 NR	TUBO FLESSIBILE	FLEXIBLE PIPE	TUYAU FLEXIBLE	SCHLAUCH	TUBO FLEXIBLE	BUIGZAME LEIDING
05	05561400	1 NR	ASTA	ROD	TIGE	STANGE	VARILLA	STANG
06	06219500	1 NR	ASTA	ROD	TIGE	STANGE	VARILLA	STANG

 **IMPIANTO IDRAULICO ALLARGAMENTO CARRO**  
 **SYSTÈME HYDRAULIQUE EXTENSION DU CHARIOT**  
 **INSTALACIÓN HIDRAULICA ENSANCHAMIENTO CARRO**

**HYDRAULIC SYSTEM UNDERCARRIAGE EXPANSION**   
**HYDRAULIKANLAGE VERBREITERUNG WAGEN**   
**HYDRAULISCHE INSTALLATIE WAGENVERBREIDING** 



 <b>IMPIANTO IDRAULICO ALLARGAMENTO CARRO</b>			<b>HYDRAULIC SYSTEM UNDERCARRIAGE EXPANSION</b> 					
 <b>SYSTÈME HYDRAULIQUE EXTENSION DU CHARIOT</b>			<b>HYDRAULIKANLAGE VERBREITERUNG WAGEN</b> 					
 <b>INSTALACIÓN HIDRAULICA ENSANCHAMIENTO CARRO</b>			<b>HYDRAULISCHE INSTALLATIE WAGENVERBREDING</b> 					
POS	Codice	Q.tà	 Descrizione	 Description	 Designation	 Benennung	 Descripción	 Beschrijving
01	05540000	2 NR	TUBO FLESSIBILE	FLEXIBLE PIPE	TUYAU FLEXIBLE	SCHLAUCH	TUBO FLEXIBLE	BUIGZAME LEIDING
02	05540100	2 NR	TUBO FLESSIBILE	FLEXIBLE PIPE	TUYAU FLEXIBLE	SCHLAUCH	TUBO FLEXIBLE	BUIGZAME LEIDING
03	05542100	2 NR	TUBO FLESSIBILE	FLEXIBLE PIPE	TUYAU FLEXIBLE	SCHLAUCH	TUBO FLEXIBLE	BUIGZAME LEIDING
04	04707700	1 NR	COLLETTORE	MANIFOLD	COLLECTEUR	KOLLEKTOR	COLECTOR	COLLECTOR

 **IMPIANTO IDRAULICO CILINDRI  
STABILIZZATORI**

 **INSTALLATION HYDRAULIQUE CYLINDRES  
STABILISATEURS**

 **INSTALACIÓN HIDRAULICA CILINDROS  
ESTABILIZADORES**





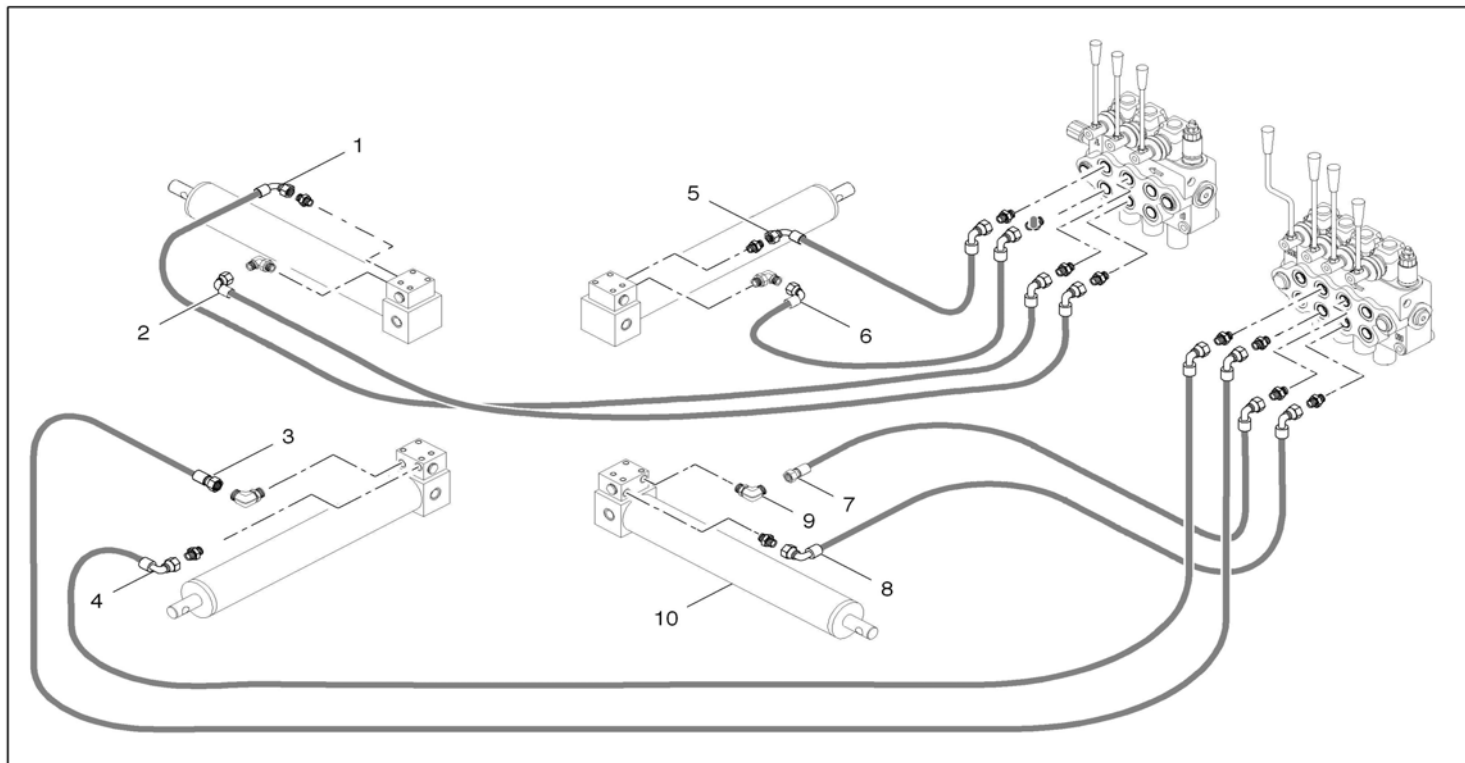

**STABILIZERS CYLINDERS HYDRAULIC SYSTEM** 

**ABSTÜTZUNGZYLINDER ABSTÜTZUNGSHYDRAULIKZYLINDER** 









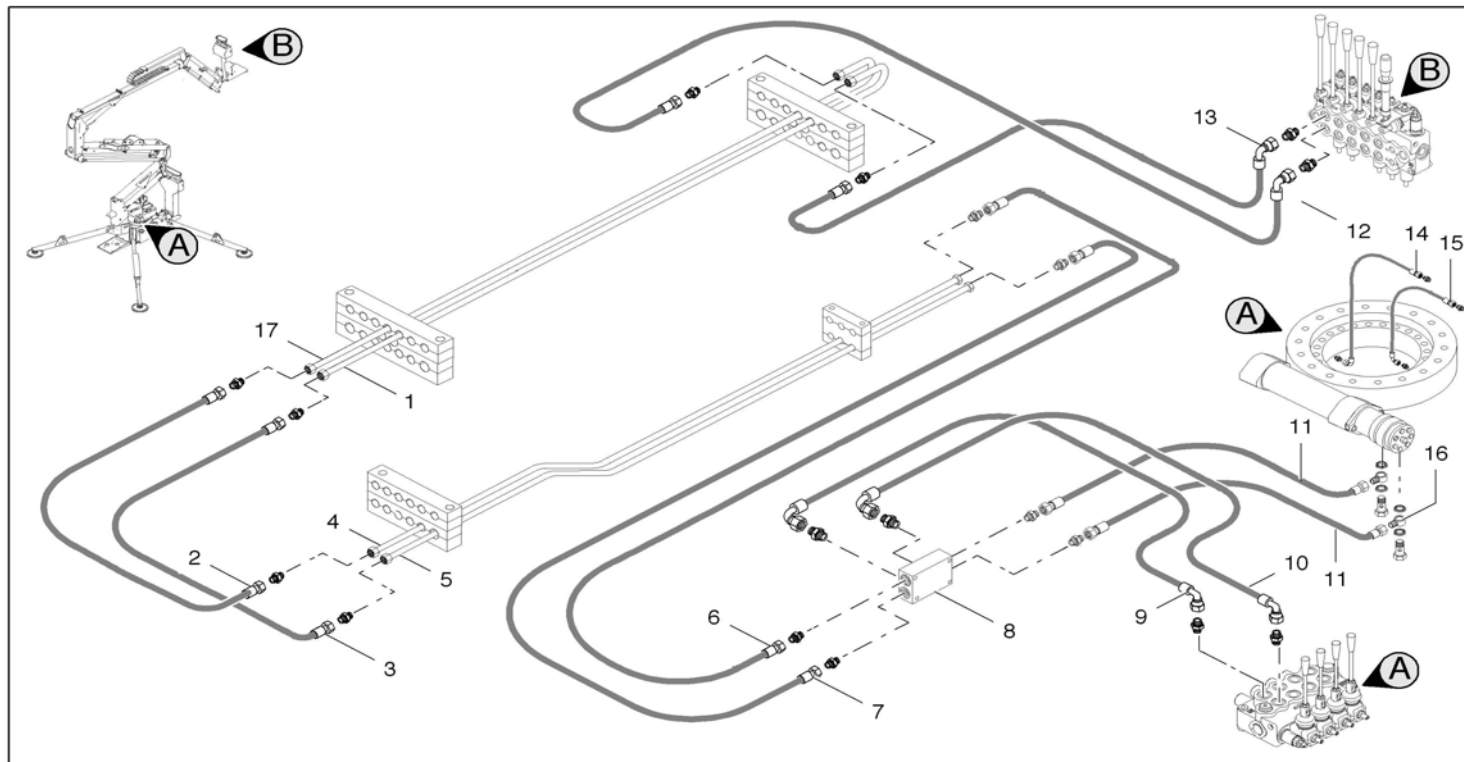

**HYDRAULISCHE INSTALLATIE STABILIZATORCILINDERS** 



**IMPIANTO IDRAULICO CILINDRI  
STABILIZZATORI**
**INSTALLATION HYDRAULIQUE CYLINDRES  
STABILISATERS**
**INSTALACIÓN HIDRAULICA CILINDROS  
ESTABILIZADORS**
**STABILIZERS CYLINDERS HYDRAULIC SYSTEM**
**ABSTÜTZUNGZYLINDER ABSTÜTZUNGSHYDRAULIKZYLINDER**
**HYDRAULISCHE INSTALLATIE STABILIZATORCILINDERS**

POS	Codice	Q.tà	 Descrizione	 Description	 Designation	 Benennung	 Descripcìon	 Beschrijving
01	05541600	1 NR	TUBO FLESSIBILE	FLEXIBLE PIPE	TUYAU FLEXIBLE	SCHLAUCH	TUBO FLEXIBLE	BUIGZAME LEIDING
02	05541700	1 NR	TUBO FLESSIBILE	FLEXIBLE PIPE	TUYAU FLEXIBLE	SCHLAUCH	TUBO FLEXIBLE	BUIGZAME LEIDING
03	05541100	1 NR	TUBO FLESSIBILE	FLEXIBLE PIPE	TUYAU FLEXIBLE	SCHLAUCH	TUBO FLEXIBLE	BUIGZAME LEIDING
04	05541000	1 NR	TUBO FLESSIBILE	FLEXIBLE PIPE	TUYAU FLEXIBLE	SCHLAUCH	TUBO FLEXIBLE	BUIGZAME LEIDING
05	05541300	1 NR	TUBO FLESSIBILE	FLEXIBLE PIPE	TUYAU FLEXIBLE	SCHLAUCH	TUBO FLEXIBLE	BUIGZAME LEIDING
06	05541200	1 NR	TUBO FLESSIBILE	FLEXIBLE PIPE	TUYAU FLEXIBLE	SCHLAUCH	TUBO FLEXIBLE	BUIGZAME LEIDING
07	05541500	1 NR	TUBO FLESSIBILE	FLEXIBLE PIPE	TUYAU FLEXIBLE	SCHLAUCH	TUBO FLEXIBLE	BUIGZAME LEIDING
08	05541400	1 NR	TUBO FLESSIBILE	FLEXIBLE PIPE	TUYAU FLEXIBLE	SCHLAUCH	TUBO FLEXIBLE	BUIGZAME LEIDING
09	05510300	2 NR	CURVA	CURVE	COURBE	KURVE	CURVA	BOCHT
10	26279200	4 NR	CILINDRO STABILIZZATORE	STABILIZER CYLINDER	CYLINDRE STABILISATEUR	ABSTÜTZUNGZYLINDER	CILINDRO ESTABILIZADOR	STABILISATORCILINDER



 <b>IMPIANTO IDRAULICO ROTAZIONE</b>  <b>SYSTÈME HYDRAULIQUE ROTATION</b>  <b>INSTALACIÓN HIDRÁULICA ROTACIÓN</b>				<b>ROTATION HYDRAULIC SYSTEM</b>  <b>HYDRAULIKANLAGE KORBSCHWENKUNG</b>  <b>HYDRAULISCHE INSTALLATIE ROTATIE</b> 				
POS	Codice	Q.tà	 Descrizione	 Description	 Designation	 Benennung	 Descripcìon	 Beschrijving
01	05554000	2 NR	TUBO RIGIDO	RIGID PIPE	TUYAU RIGIDE	ROHR	TUBO RÍGIDO	OMBUIGZAME LEIDING
02	05545400	1 NR	TUBO FLESSIBILE	FLEXIBLE PIPE	TUYAU FLEXIBLE	SCHLAUCH	TUBO FLEXIBLE	BUIGZAME LEIDING
03	05545300	2 NR	TUBO FLESSIBILE	FLEXIBLE PIPE	TUYAU FLEXIBLE	SCHLAUCH	TUBO FLEXIBLE	BUIGZAME LEIDING
04	05553800	1 NR	TUBO RIGIDO	RIGID PIPE	TUYAU RIGIDE	ROHR	TUBO RÍGIDO	OMBUIGZAME LEIDING
05	05553700	1 NR	TUBO RIGIDO	RIGID PIPE	TUYAU RIGIDE	ROHR	TUBO RÍGIDO	OMBUIGZAME LEIDING
06	05543500	1 NR	TUBO FLESSIBILE	FLEXIBLE PIPE	TUYAU FLEXIBLE	SCHLAUCH	TUBO FLEXIBLE	BUIGZAME LEIDING
07	05543600	1 NR	TUBO FLESSIBILE	FLEXIBLE PIPE	TUYAU FLEXIBLE	SCHLAUCH	TUBO FLEXIBLE	BUIGZAME LEIDING
08	05497200	2 NR	BLOCCHETTO	BLOCK	BLOC	BLOCK	BLOQUE	BLOKJE
09	05544100	1 NR	TUBO FLESSIBILE	FLEXIBLE PIPE	TUYAU FLEXIBLE	SCHLAUCH	TUBO FLEXIBLE	BUIGZAME LEIDING
10	05544200	1 NR	TUBO FLESSIBILE	FLEXIBLE PIPE	TUYAU FLEXIBLE	SCHLAUCH	TUBO FLEXIBLE	BUIGZAME LEIDING
11	05544300	2 NR	TUBO FLESSIBILE	FLEXIBLE PIPE	TUYAU FLEXIBLE	SCHLAUCH	TUBO FLEXIBLE	BUIGZAME LEIDING
12	05546100	4 NR	TUBO FLESSIBILE	FLEXIBLE PIPE	TUYAU FLEXIBLE	SCHLAUCH	TUBO FLEXIBLE	BUIGZAME LEIDING
13	05546000	5 NR	TUBO FLESSIBILE	FLEXIBLE PIPE	TUYAU FLEXIBLE	SCHLAUCH	TUBO FLEXIBLE	BUIGZAME LEIDING
14	05540200	1 NR	TUBO FLESSIBILE	FLEXIBLE PIPE	TUYAU FLEXIBLE	SCHLAUCH	TUBO FLEXIBLE	BUIGZAME LEIDING
15	05540300	1 NR	TUBO FLESSIBILE	FLEXIBLE PIPE	TUYAU FLEXIBLE	SCHLAUCH	TUBO FLEXIBLE	BUIGZAME LEIDING
16	05725900	2 NR	RACCORDO	FITTING	RACCORD	ANSCHLUSS	CONEXIÓN	VERBINDING
17	05554100	3 NR	TUBO RIGIDO	RIGID PIPE	TUYAU RIGIDE	ROHR	TUBO RÍGIDO	OMBUIGZAME LEIDING

 **IMPIANTO IDRAULICO CILINDRI 1-2 BRACCI**  
 **SYSTÈME HYDRAULIQUE CYLINDRES 1-2 BRAS**  
 **INSTALACIÓN HIDRÁULICA CILINDROS 1-2 BRAZOS**

**1-2 ARMS CYLINDERS HYDRAULIC SYSTEM**   
**HYDRAULIKANLAGE ZYLINDER 1-2 ARM**   
**HYDRAULISCHE INSTALLATIE CILINDERS 1-2 ARM** 

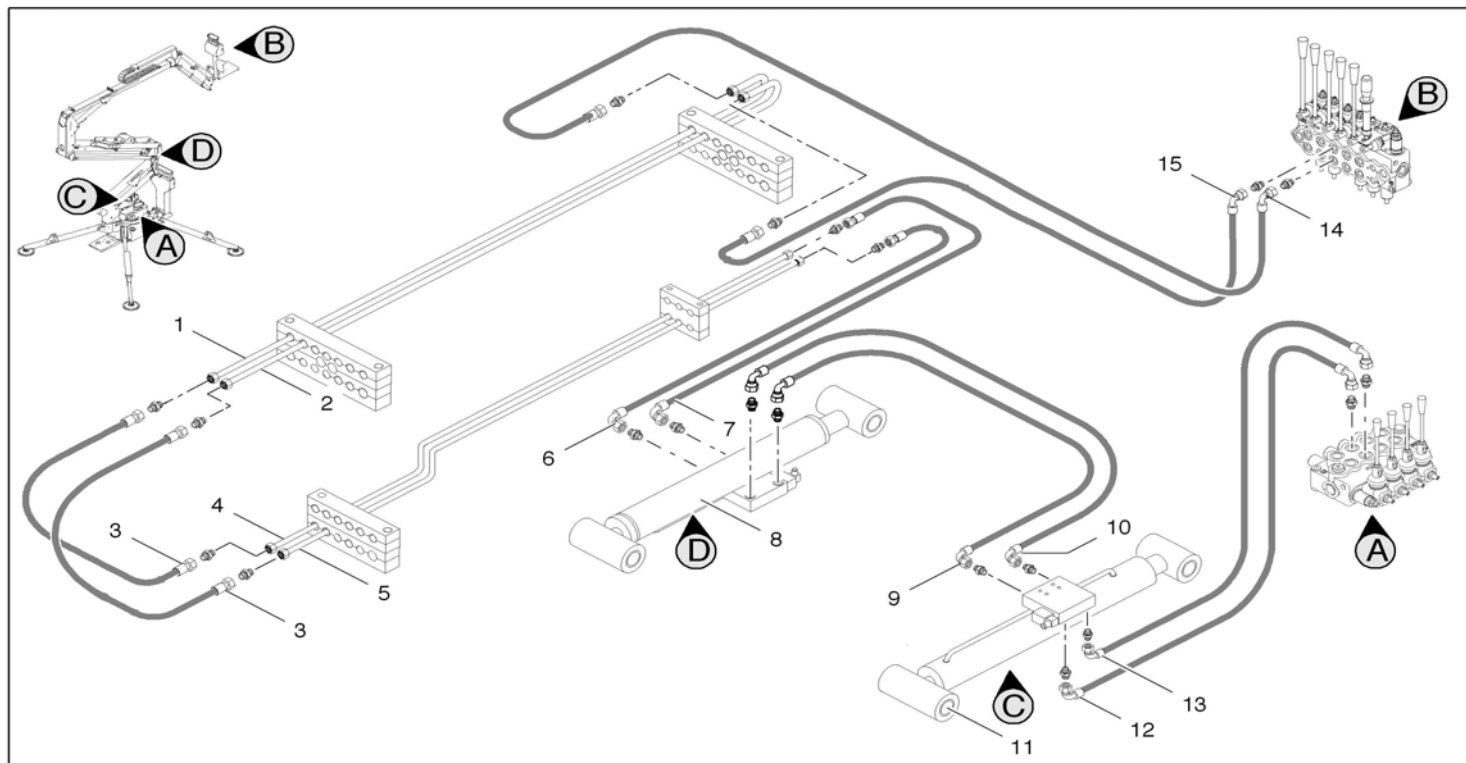



 <b>IMPIANTO IDRAULICO CILINDRI 1-2 BRACCI</b>  <b>SYSTÈME HYDRAULIQUE CYLINDRES 1-2 BRAS</b>  <b>INSTALACIÓN HIDRÁULICA CILINDROS 1-2 BRAZOS</b>			<b>1-2 ARMS CYLINDERS HYDRAULIC SYSTEM</b>  <b>HYDRAULIKANLAGE ZYLINDER 1-2 ARM</b>  <b>HYDRAULISCHE INSTALLATIE CILINDERS 1-2 ARM</b> 					
POS	Codice	Q.tà	 Descrizione	 Description	 Designation	 Benennung	 Descripcìon	 Beschrijving
01	05554000	1 NR	TUBO RIGIDO	RIGID PIPE	TUYAU RIGIDE	ROHR	TUBO RÍGIDO	OMBUIGZAME LEIDING
02	05554100	1 NR	TUBO RIGIDO	RIGID PIPE	TUYAU RIGIDE	ROHR	TUBO RÍGIDO	OMBUIGZAME LEIDING
03	05545200	2 NR	TUBO FLESSIBILE	FLEXIBLE PIPE	TUYAU FLEXIBLE	SCHLAUCH	TUBO FLEXIBLE	BUIGZAME LEIDING
04	05553600	1 NR	TUBO RIGIDO	RIGID PIPE	TUYAU RIGIDE	ROHR	TUBO RÍGIDO	OMBUIGZAME LEIDING
05	05553500	1 NR	TUBO RIGIDO	RIGID PIPE	TUYAU RIGIDE	ROHR	TUBO RÍGIDO	OMBUIGZAME LEIDING
06	05544500	1 NR	TUBO FLESSIBILE	FLEXIBLE PIPE	TUYAU FLEXIBLE	SCHLAUCH	TUBO FLEXIBLE	BUIGZAME LEIDING
07	05659900	1 NR	TUBO FLESSIBILE	FLEXIBLE PIPE	TUYAU FLEXIBLE	SCHLAUCH	TUBO FLEXIBLE	BUIGZAME LEIDING
08	26278700	1 NR	SECONDO BRACCIO	SECOND ARM	SECOND BRAS	ZWEITER AUSLEGERARM	SEGUNDO BRAZO	TWEDE ARM
09	05544000	1 NR	TUBO FLESSIBILE	FLEXIBLE PIPE	TUYAU FLEXIBLE	SCHLAUCH	TUBO FLEXIBLE	BUIGZAME LEIDING
10	05543900	1 NR	TUBO FLESSIBILE	FLEXIBLE PIPE	TUYAU FLEXIBLE	SCHLAUCH	TUBO FLEXIBLE	BUIGZAME LEIDING
11	26278600	1 NR	CILINDRO PRIMO BRACCIO	CYLINDER FIRST ARM	CYLINDRE PREMIÈRE BRAS	ZYLINDER ERSTE ARM	CILINDRO PRIMERA EL BRAZO	CILINDER EERSTE ARM
12	05543800	1 NR	TUBO FLESSIBILE	FLEXIBLE PIPE	TUYAU FLEXIBLE	SCHLAUCH	TUBO FLEXIBLE	BUIGZAME LEIDING
13	05543700	1 NR	TUBO FLESSIBILE	FLEXIBLE PIPE	TUYAU FLEXIBLE	SCHLAUCH	TUBO FLEXIBLE	BUIGZAME LEIDING
14	05546100	1 NR	TUBO FLESSIBILE	FLEXIBLE PIPE	TUYAU FLEXIBLE	SCHLAUCH	TUBO FLEXIBLE	BUIGZAME LEIDING
15	05546000	1 NR	TUBO FLESSIBILE	FLEXIBLE PIPE	TUYAU FLEXIBLE	SCHLAUCH	TUBO FLEXIBLE	BUIGZAME LEIDING





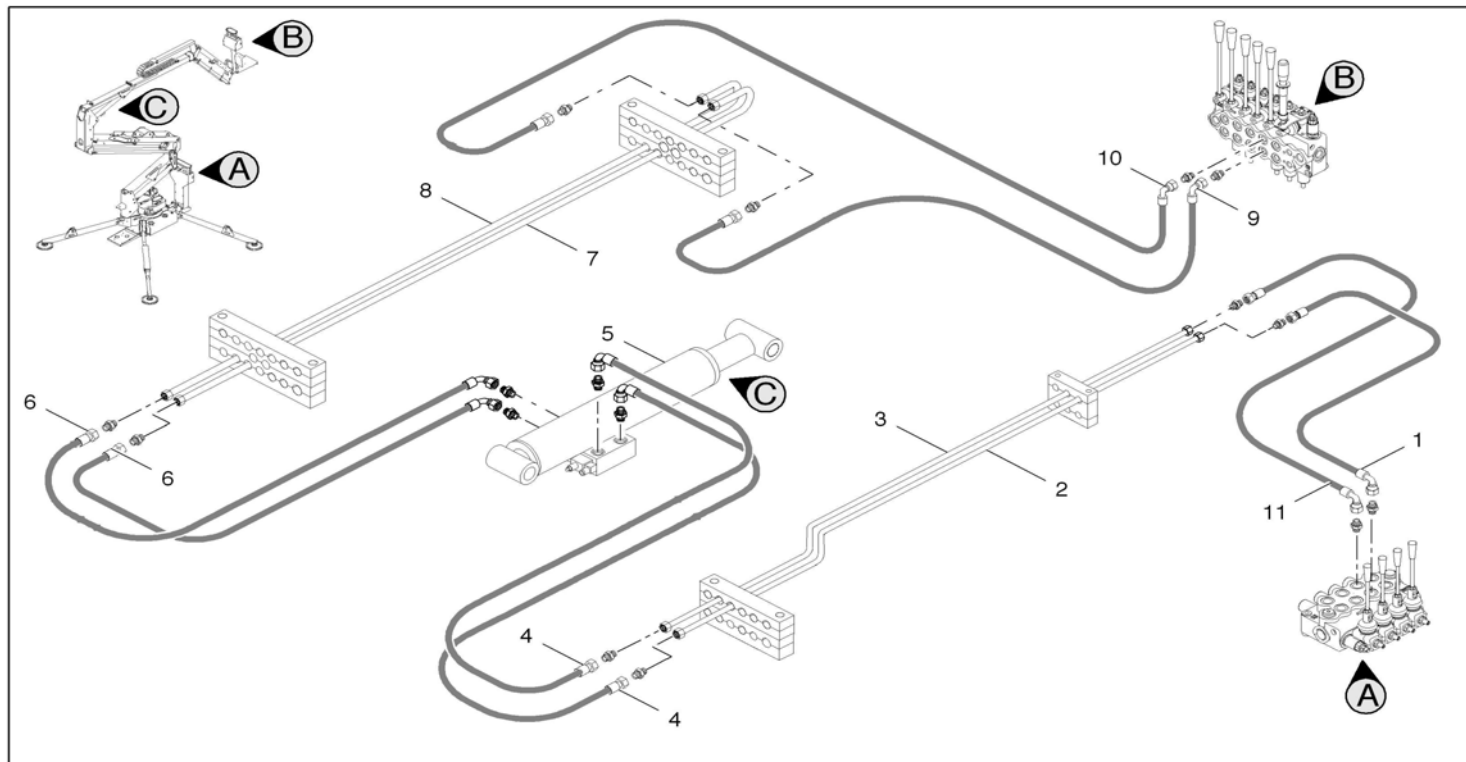



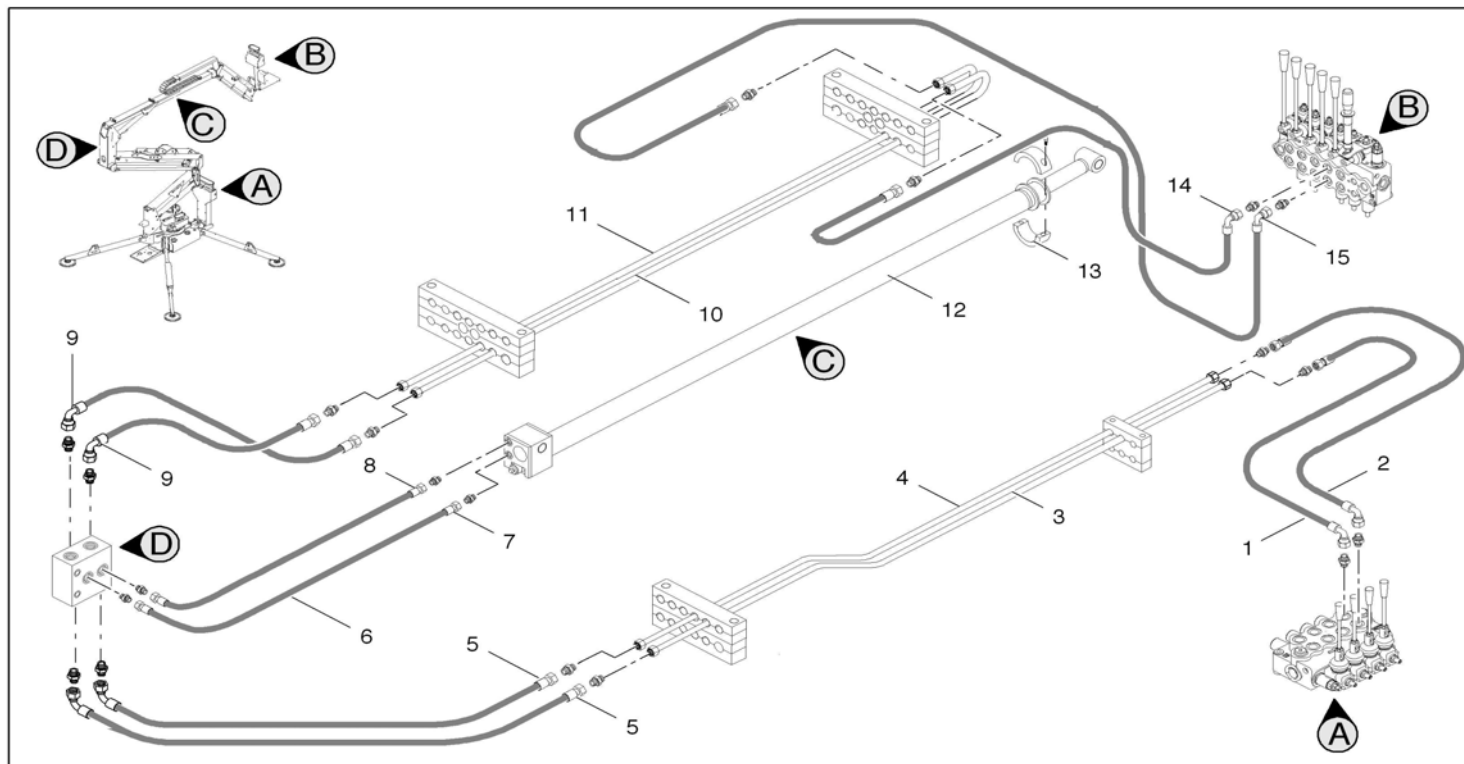

 **IMPIANTO IDRAULICO CILINDRO 3 BRACCIO**  
 **SYSTÈME HYDRAULIQUE CYLINDRE 3 BRAS**  
 **INSTALACIÓN HIDRÁULICA CILINDRO 3 BRAZO**

**3 ARM CYLINDER HYDRAULIC SYSTEM**   
**HYDRAULIKANLAGE ZYLINDER 3 ARM**   
**HYDRAULISCHE INSTALLATIE CILINDER 3 ARM** 



 <b>IMPIANTO IDRAULICO CILINDRO 3 BRACCIO</b>  <b>SYSTÈME HYDRAULIQUE CYLINDRE 3 BRAS</b>  <b>INSTALACIÓN HIDRÁULICA CILINDRO 3 BRAZO</b>			<b>3 ARM CYLINDER HYDRAULIC SYSTEM</b>  <b>HYDRAULIKANLAGE ZYLINDER 3 ARM</b>  <b>HYDRAULISCHE INSTALLATIE CILINDER 3 ARM</b> 					
POS	Codice	Q.tà	 Descrizione	 Description	 Designation	 Benennung	 Descripcìon	 Beschrijving
01	05543400	1 NR	TUBO FLESSIBILE	TUYAU FLEXIBLE	SCHLAUCH	SCHLAUCH	TUBO FLEXIBLE	BUIGZAME LEIDING
02	05553400	1 NR	TUBO RIGIDO	RIGID PIPE	TUYAU RIGIDE	ROHR	TUBO RÍGIDO	OMBUIGZAME LEIDING
03	05553300	1 NR	TUBO RIGIDO	RIGID PIPE	TUYAU RIGIDE	ROHR	TUBO RÍGIDO	OMBUIGZAME LEIDING
04	05544800	2 NR	TUBO FLESSIBILE	FLEXIBLE PIPE	TUYAU FLEXIBLE	SCHLAUCH	TUBO FLEXIBLE	BUIGZAME LEIDING
05	26278800	1 NR	CILINDRO TERZO BRACCIO	THIRD ARM CYLINDER	CYLINDRE TROISIÈME BRAS	ZYLINDER DRITTEN ARM	CILINDRO TERCERO BRAZO	CILINDER DERDE ARM
06	05544900	2 NR	TUBO FLESSIBILE	FLEXIBLE PIPE	TUYAU FLEXIBLE	SCHLAUCH	TUBO FLEXIBLE	BUIGZAME LEIDING
07	05552500	1 NR	TUBO RIGIDO	RIGID PIPE	TUYAU RIGIDE	ROHR	OMBUIGZAME LEIDING	TUBO RÍGIDO
08	05552400	1 NR	TUBO RIGIDO	RIGID PIPE	TUYAU RIGIDE	ROHR	TUBO RÍGIDO	OMBUIGZAME LEIDING
09	05546100	1 NR	TUBO FLESSIBILE	FLEXIBLE PIPE	TUYAU FLEXIBLE	SCHLAUCH	TUBO FLEXIBLE	BUIGZAME LEIDING
10	05546000	1 NR	TUBO FLESSIBILE	FLEXIBLE PIPE	TUYAU FLEXIBLE	SCHLAUCH	TUBO FLEXIBLE	BUIGZAME LEIDING
11	05543300	1 NR	TUBO FLESSIBILE	FLEXIBLE PIPE	TUYAU FLEXIBLE	SCHLAUCH	TUBO FLEXIBLE	BUIGZAME LEIDING





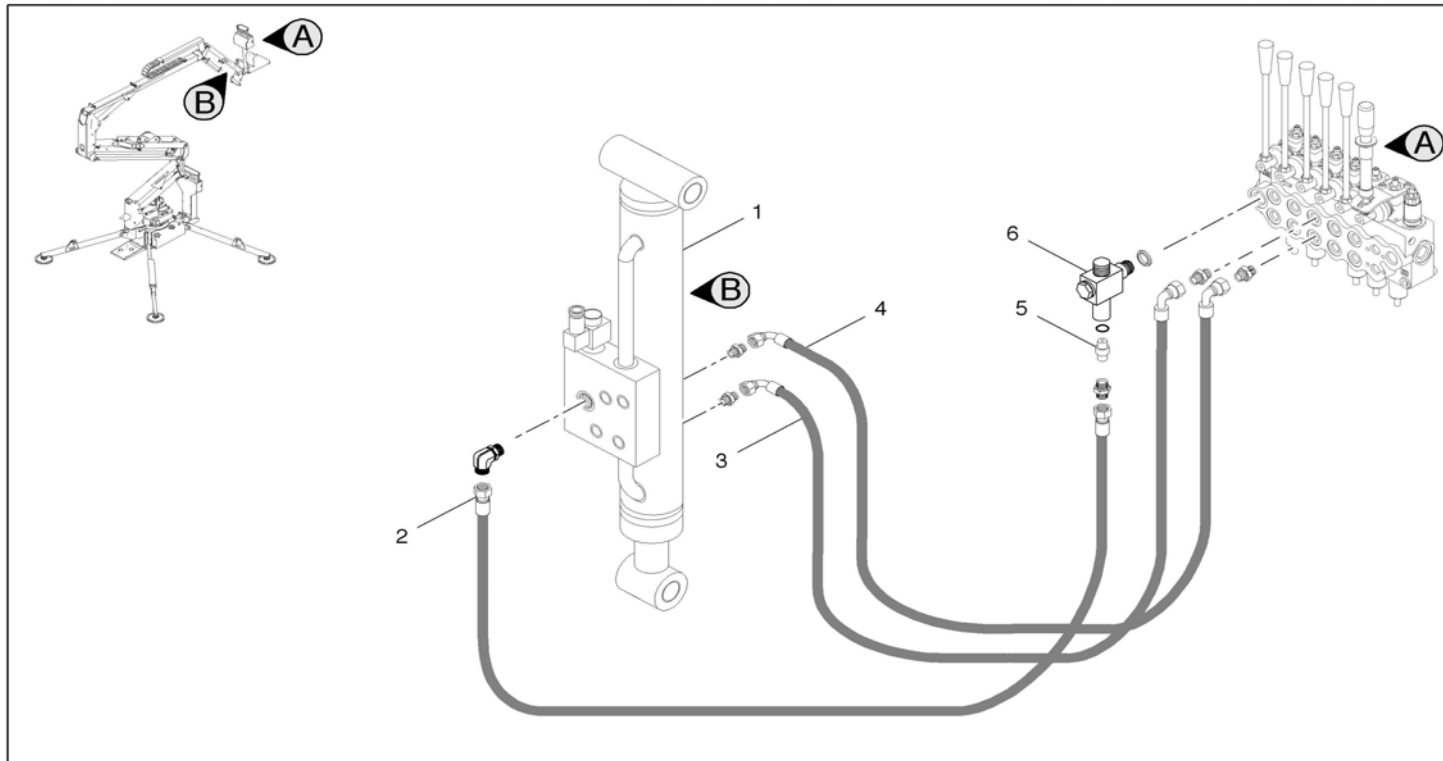



 <b>IMPIANTO IDRAULICO SFILO</b>  <b>TELESCOPIQUE HYDRAULIQUE</b>  <b>INSTALACIÓN EXTENSIÓN HIDRÁULICA</b>				<b>TELESCOPIC HYDRAULIC SYSTEM</b>  <b>TELESKOPHYDRAULIK</b>  <b>EXTRACTE HYDRAULISCHE</b> 				
POS	Codice	Q.tà	 Descrizione	 Description	 Designation	 Benennung	 Descripcìon	 Beschrijving
01	05543100	1 NR	TUBO FLESSIBILE	FLEXIBLE PIPE	TUYAU FLEXIBLE	SCHLAUCH	TUBO FLEXIBLE	BUIGZAME LEIDING
02	05543200	1 NR	TUBO FLESSIBILE	FLEXIBLE PIPE	TUYAU FLEXIBLE	SCHLAUCH	TUBO FLEXIBLE	BUIGZAME LEIDING
03	05553100	1 NR	TUBO RIGIDO	RIGID PIPE	TUYAU RIGIDE	ROHR	TUBO RÍGIDO	OMBUIGZAME LEIDING
04	05553200	1 NR	TUBO RIGIDO	RIGID PIPE	TUYAU RIGIDE	ROHR	TUBO RÍGIDO	OMBUIGZAME LEIDING
05	05545000	2 NR	TUBO FLESSIBILE	FLEXIBLE PIPE	TUYAU FLEXIBLE	SCHLAUCH	TUBO FLEXIBLE	BUIGZAME LEIDING
06	05497200	1 NR	BLOCCHETTO	BLOCK	BLOC	BLOCK	BLOQUE	BLOKJE
07	05545500	1 NR	TUBO FLESSIBILE	FLEXIBLE PIPE	TUYAU FLEXIBLE	SCHLAUCH	TUBO FLEXIBLE	BUIGZAME LEIDING
08	05545600	1 NR	TUBO FLESSIBILE	FLEXIBLE PIPE	TUYAU FLEXIBLE	SCHLAUCH	TUBO FLEXIBLE	BUIGZAME LEIDING
09	05545100	2 NR	TUBO FLESSIBILE	FLEXIBLE PIPE	TUYAU FLEXIBLE	SCHLAUCH	TUBO FLEXIBLE	BUIGZAME LEIDING
10	05552400	2 NR	TUBO RIGIDO	RIGID PIPE	TUYAU RIGIDE	ROHR	TUBO RÍGIDO	OMBUIGZAME LEIDING
11	05552500	2 NR	TUBO RIGIDO	RIGID PIPE	TUYAU RIGIDE	ROHR	OMBUIGZAME LEIDING	TUBO RÍGIDO
12	26279300	1 NR	CILINDRO SFILO	EXTENSION CYLINDER	CYLINDRE SECT. TÉLESCOP.	TELESKOPZYLINDER	CIL. BRAZO TELESCÓP.	CILINDER EXTRACTIE
13	05502100	1 NR	ANELLO	RING	BAGUE	RING	ANILLO	RING
14	05546000	1 NR	TUBO FLESSIBILE	FLEXIBLE PIPE	TUYAU FLEXIBLE	SCHLAUCH	TUBO FLEXIBLE	BUIGZAME LEIDING
15	05546100	1 NR	TUBO FLESSIBILE	FLEXIBLE PIPE	TUYAU FLEXIBLE	SCHLAUCH	TUBO FLEXIBLE	BUIGZAME LEIDING





 **IMPIANTO JIB**  
 **SYSTÈME HYDRAULIQUE JIB**  
 **INSTALACIÓN HIDRÁULICA JIB**

**JIB HYDRAULIC SYSTEM**   
**ZYLINDER JIB ARM**   
**HYDRAULISCHE INSTALLATIE JIB** 

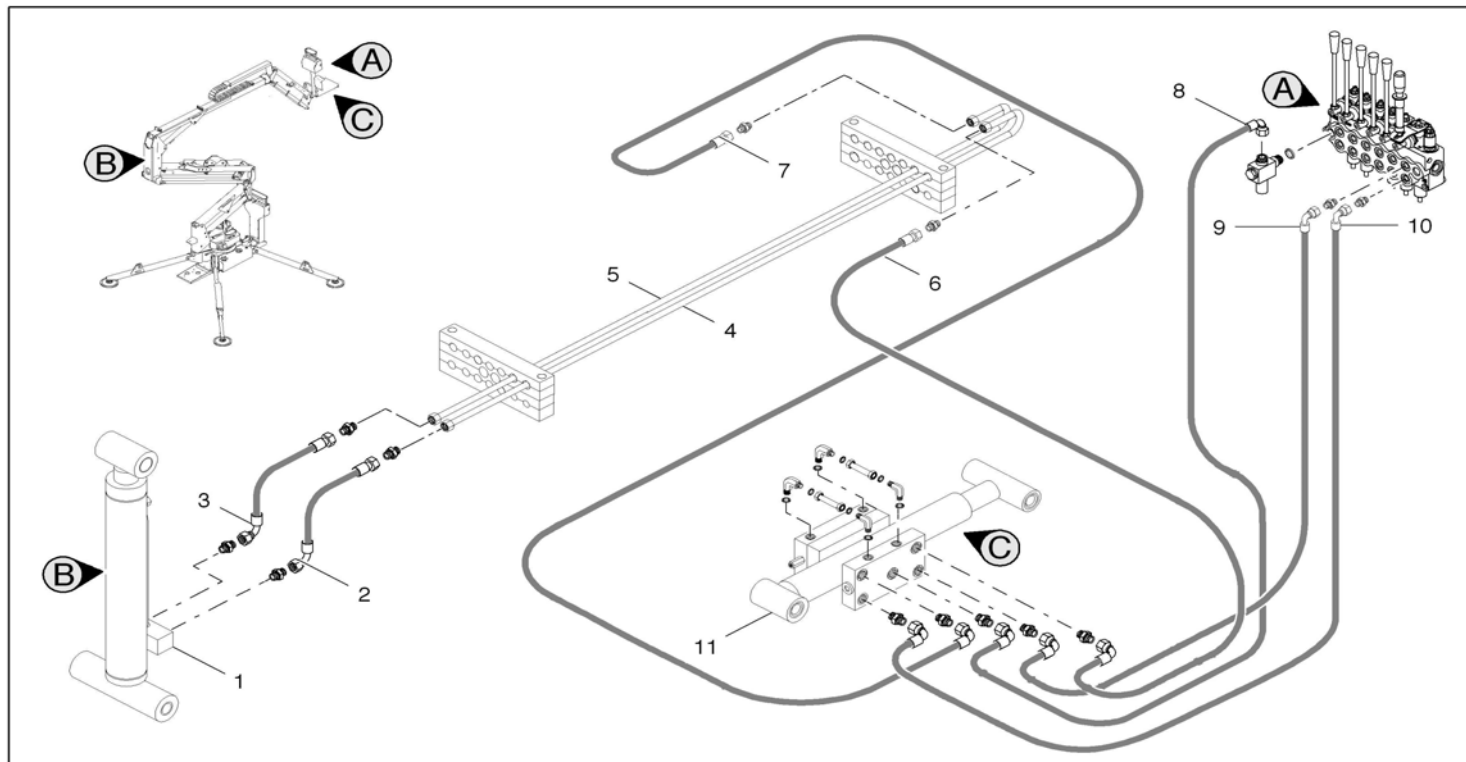







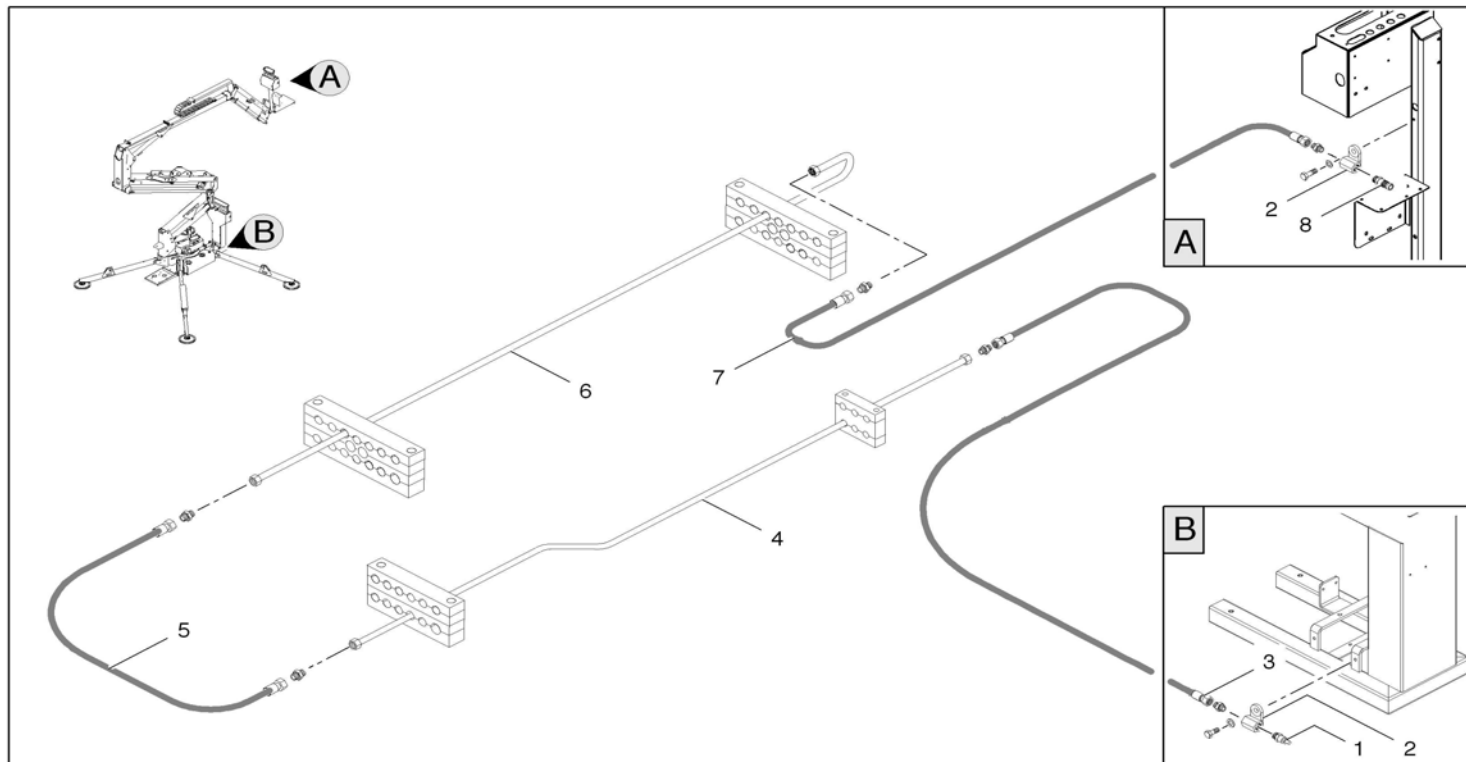



POS	Codice	Q.tà	 Descrizione	 Description	 Designation	 Benennung	 Descripción	 Beschrijving
01	26279100	1 NR	CILINDRO JIB	JIB CYLINDER	CYLINDRE FLÉCHETTE	SCHWENKARMHYZLIN DER	CILINDRO PLUMA	CILINDER JIB SYSTEEM
02	05623700	1 NR	TUBO FLESSIBILE	FLEXIBLE PIPE	TUYAU FLEXIBLE	SCHLAUCH	TUBO FLEXIBLE	BUIGZAME LEIDING
03	05546200	1 NR	TUBO FLESSIBILE	FLEXIBLE PIPE	TUYAU FLEXIBLE	SCHLAUCH	TUBO FLEXIBLE	BUIGZAME LEIDING
04	05546300	1 NR	TUBO FLESSIBILE	FLEXIBLE PIPE	TUYAU FLEXIBLE	SCHLAUCH	TUBO FLEXIBLE	BUIGZAME LEIDING
05	05603600	1 NR	CARTUCCIA OLIO IDR.	HYDR. OIL CARTRIDGE	CARTOUCHE HUILE HYDR.	HYDRAULIKÖLEINSA TZ	CARTUCHO ACEITE HIDR.	PATROON HYDR. OLIE
06	05603500	1 NR	RACCORDO	FITTING	RACCORD	ANSCHLUSS	CONEXIÓN	VERBINDING





 <b>IMPIANTO IDRAULICO LIVELLAMENTO</b>  <b>SYSTÈME HYDRAULIQUE CYLINDRES BRAS</b>  <b>INSTALACIÓN HIDRÁULICA CILINDROS BRAZOS</b>			<b>LEVELING CYLINDERS HYDRAULIC SYSTEM</b>  <b>HYDRAULIKANLAGE ZYLINDER ARM</b>  <b>HYDRAULISCHE INSTALLATIE CILINDERS ARM</b> 					
POS	Codice	Q.tà	 Descrizione	 Description	 Designation	 Benennung	 Descripción	 Beschrijving
01	26278900	1 NR	CILINDRO LIVELLAMENTO CESTO	BASKET LEVELING CYLINDER	CYLINDRE MISE À NIVEAU NACELLE	ZYLINDER NIVELLIERUNG GONDEL	CILINDRO DE NIVELACIÓN AULA	CILINDER NIVELLERING KORP
02	05545700	1 NR	TUBO FLESSIBILE	FLEXIBLE PIPE	TUYAU FLEXIBLE	SCHLAUCH	TUBO FLEXIBLE	BUIGZAME LEIDING
03	05545800	1 NR	TUBO FLESSIBILE	FLEXIBLE PIPE	TUYAU FLEXIBLE	SCHLAUCH	TUBO FLEXIBLE	BUIGZAME LEIDING
04	05554000	4 NR	TUBO RIGIDO	RIGID PIPE	TUYAU RIGIDE	ROHR	TUBO RÍGIDO	OMBUIGZAME LEIDING
05	05554100	1 NR	TUBO RIGIDO	RIGID PIPE	TUYAU RIGIDE	ROHR	TUBO RÍGIDO	OMBUIGZAME LEIDING
06	05546600	1 NR	TUBO FLESSIBILE	FLEXIBLE PIPE	TUYAU FLEXIBLE	SCHLAUCH	TUBO FLEXIBLE	BUIGZAME LEIDING
07	05546700	1 NR	TUBO FLESSIBILE	FLEXIBLE PIPE	TUYAU FLEXIBLE	SCHLAUCH	TUBO FLEXIBLE	BUIGZAME LEIDING
08	05623800	1 NR	TUBO FLESSIBILE	FLEXIBLE PIPE	TUYAU FLEXIBLE	SCHLAUCH	TUBO FLEXIBLE	BUIGZAME LEIDING
09	05546400	1 NR	TUBO FLESSIBILE	FLEXIBLE PIPE	TUYAU FLEXIBLE	SCHLAUCH	TUBO FLEXIBLE	BUIGZAME LEIDING
10	05546500	1 NR	TUBO FLESSIBILE	FLEXIBLE PIPE	TUYAU FLEXIBLE	SCHLAUCH	TUBO FLEXIBLE	BUIGZAME LEIDING
11	26279000	1 NR	CILINDRO LIVELLAMENTO CESTO	BASKET LEVELING CYLINDER	CYLINDRE MISE À NIVEAU NACELLE	ZYLINDER NIVELLIERUNG GONDEL	CILINDRO DE NIVELACIÓN AULA	CILINDER NIVELLERING KORP





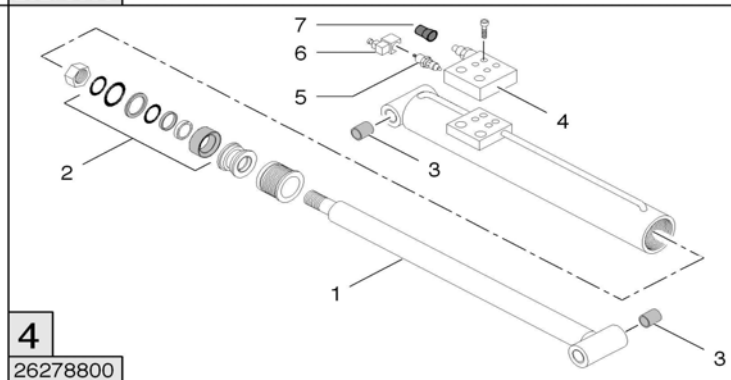
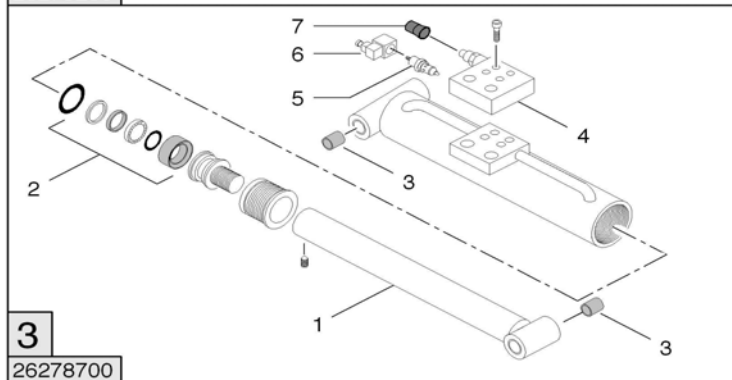
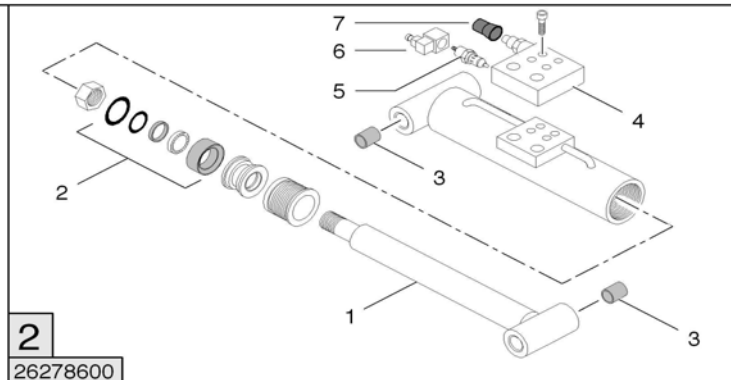
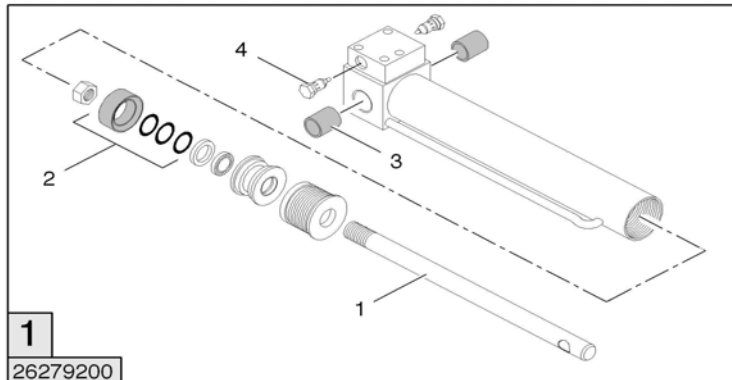

 <b>IMPIANTO IDRAULICO ARIA COMPRESSA</b>  <b>SYSTÈME HYDRAULIQUE AIR COMPRIMÉ</b>  <b>INSTALACIÓN HIDRÁULICA AIRE COMPRIMIDO</b>				<b>COMPRESSED AIR HYDRAULIC SYSTEM</b>  <b>HYDRAULIKANLAGE DRUCKLUFT</b>  <b>HYDRAULISCHE INSTALLATIE PERSLUCHT</b> 				
POS	Codice	Q.tà	 Descrizione	 Description	 Designation	 Benennung	 Descripción	 Beschrijving
01	05509900	1 NR	INNESTO RAPIDO	QUICK COUPLING	RACCORD RAPIDE	SCHNELLKUPPLUNG	CONEXIÓN RÁPIDA	SNELKOPPELING
02	04845100	2 NR	SUPPORTO	SUPPORT	SUPPORT	HALTERUNG	SOPORTE	SUPPORT
03	05544400	1 NR	TUBO FLESSIBILE	FLEXIBLE PIPE	TUYAU FLEXIBLE	SCHLAUCH	TUBO FLEXIBLE	BUIGZAME LEIDING
04	05553900	1 NR	TUBO RIGIDO	RIGID PIPE	TUYAU RIGIDE	ROHR	TUBO RÍGIDO	OMBUIGZAME LEIDING
05	05545300	1 NR	TUBO FLESSIBILE	FLEXIBLE PIPE	TUYAU FLEXIBLE	SCHLAUCH	TUBO FLEXIBLE	BUIGZAME LEIDING
06	05554000	1 NR	TUBO RIGIDO	RIGID PIPE	TUYAU RIGIDE	ROHR	TUBO RÍGIDO	OMBUIGZAME LEIDING
07	05546000	1 NR	TUBO FLESSIBILE	FLEXIBLE PIPE	TUYAU FLEXIBLE	SCHLAUCH	TUBO FLEXIBLE	BUIGZAME LEIDING
08	05580200	1 NR	RUBINETTO	FAUCET	ROBINET	WASSERHAHN	GRIFO	KRAAN

**RICAMBI CILINDRI**  
**RECHANGE DE CYLINDERS**  
**RECAMBIO PARA LOS CILINDROS**





**CYLINDERS SPARE PARTS**  
**ERSATZTEILE ZYLINDERKOMPONENTEN**  
**RESERVEONDERDELEN VAN CILINDERS**



 <b>RICAMBI CILINDRI</b>  <b>RECHANGE DE CYLINDERS</b>  <b>RECAMBIO PARA LOS CILINDROS</b>			<b>CYLINDERS SPARE PARTS</b>  <b>ERSATZTEILE ZYLINDERKOMPONENTEN</b>  <b>RESERVEONDERDELEN VAN CILINDERS</b> 						
POS	Codice	Q.tà	 Descrizione	 Description	 Designation	 Benennung	 Descripción	 Beschrijving	
01 01	2627920001	1 NR	STELO	ROD	TIGE	SCHAFT	VÁSTAGO	STEEL	
01 02	2627920007	1 NR	KIT GUARNIZIONI	GASKET KIT	KIT JOINTS	DICHTUNGSSATZ	KIT GUARNICIÓNES	KIT PAKKINGEN	
01 03	2627920006	2 NR	BOCCOLA	BUSH	DOUILLE	BUCHSE	CASQUILLO	BUS	
01 04	1541150011	1 NR	VALVOLA IDRAULICA	HYDRAULIC VALVE	VALVE HYDRAULIQUE	VALVE HYDRAULIQUE	VÁLVULA HIDRÁULICA	HYDRAULISCHE KLEP	
02 01	2627860001	1 NR	STELO	ROD	TIGE	SCHAFT	VÁSTAGO	STEEL	
02 02	2627860005	1 NR	KIT GUARNIZIONI	GASKET KIT	KIT JOINTS	DICHTUNGSSATZ	KIT GUARNICIÓNES	KIT PAKKINGEN	
02 03	2627860006	4 NR	BOCCOLA	BUSH	DOUILLE	BUCHSE	CASQUILLO	BUS	
02 04	05525500	1 NR	VALVOLA IDRAULICA	HYDRAULIC VALVE	VALVE HYDRAULIQUE	VALVE HYDRAULIQUE	VÁLVULA HIDRÁULICA	HYDRAULISCHE KLEP	
02 05	0552550001	1 NR	ELETTROVALVOLA	SOLENOID VALVE	ÉLECTROVANNE	MAGNETVENTIL	ELECTROVÁLVULA	ELEKTROKLEP	
02 06	0552550003	1 NR	BOBINA	COIL	BOBINE	SPULE	BOBINA	SPOEL	
02 07	05576200	1 NR	PROTEZIONE	PROTECTION	PROTECTION	SCHUTZ	PROTECCIÓN	BESCHERMING	
03 01	2627870001	1 NR	STELO	ROD	TIGE	SCHAFT	VÁSTAGO	STEEL	
03 02	2627870006	1 NR	KIT GUARNIZIONI	GASKET KIT	KIT JOINTS	DICHTUNGSSATZ	KIT GUARNICIÓNES	KIT PAKKINGEN	
03 03	2627870005	4 NR	BOCCOLA	BUSH	DOUILLE	BUCHSE	CASQUILLO	BUS	
03 04	05525500	1 NR	VALVOLA IDRAULICA	HYDRAULIC VALVE	VALVE HYDRAULIQUE	VALVE HYDRAULIQUE	VÁLVULA HIDRÁULICA	HYDRAULISCHE KLEP	
03 05	0552550001	1 NR	ELETTROVALVOLA	SOLENOID VALVE	ÉLECTROVANNE	MAGNETVENTIL	ELECTROVÁLVULA	ELEKTROKLEP	
03 06	0552550003	1 NR	BOBINA	COIL	BOBINE	SPULE	BOBINA	SPOEL	

 **RICAMBI CILINDRI**  
 **RECHANGE DE CYLINDERS**  
 **RECAMBIO PARA LOS CILINDROS**

**CYLINDERS SPARE PARTS**   
**ERSATZTEILE ZYLINDERKOMPONENTEN**   
**RESERVEONDERDELEN VAN CILINDERS** 

POS	Codice	Q.tà	 Descrizione	 Description	 Designation	 Benennung	 Descripción	 Beschrijving
03	07 05576200	1 NR	PROTEZIONE	PROTECTION	PROTECTION	SCHUTZ	PROTECCIÓN	BESCHERMING
04	01 2627880001	1 NR	STELO	ROD	TIGE	SCHAFT	VÁSTAGO	STEEL
04	02 2627880006	1 NR	KIT GUARNIZIONI	GASKET KIT	KIT JOINTS	DICHTUNGSSATZ	KIT GUARNICIONES	KIT PAKKINGEN
04	03 2627880005	4 NR	BOCCOLA	BUSH	DOUILLE	BUCHSE	CASQUILLO	BUS
04	04 05525500	1 NR	VALVOLA IDRAULICA	HYDRAULIC VALVE	VALVE HYDRAULIQUE	VALVE HYDRAULIQUE	VÁLVULA HIDRÁULICA	HYDRAULISCHE KLEP
04	05 0552550001	1 NR	ELETTROVALVOLA	SOLENOID VALVE	ÉLECTROVANNE	MAGNETVENTIL	ELECTROVÁLVULA	ELEKTROKLEP
04	06 0552550003	1 NR	BOBINA	COIL	BOBINE	SPULE	BOBINA	SPOEL
04	07 05576200	1 NR	PROTEZIONE	PROTECTION	PROTECTION	SCHUTZ	PROTECCIÓN	BESCHERMING



 **RICAMBI CILINDRI**  
 **RECHANGE DE CYLINDERS**  
 **RECAMBIO PARA LOS CILINDROS**

**CYLINDERS SPARE PARTS**   
**ERSATZTEILE ZYLINDERKOMPONENTEN**   
**RESERVEONDERDELEN VAN CILINDERS** 

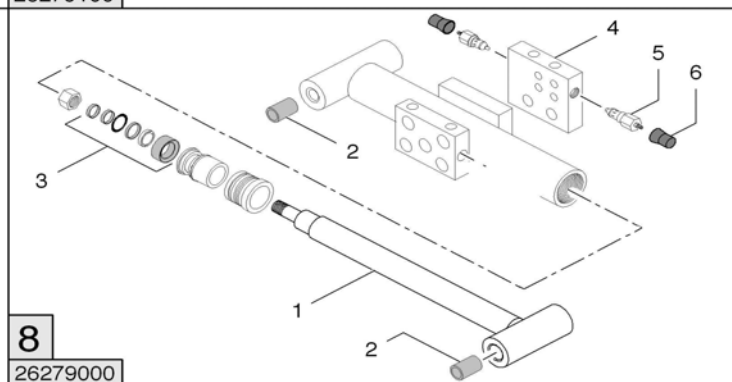
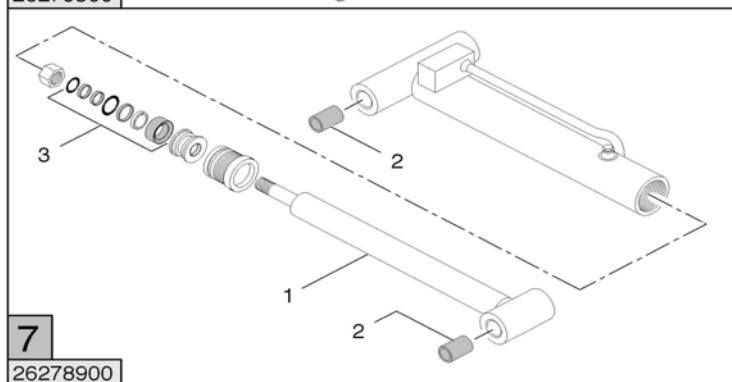
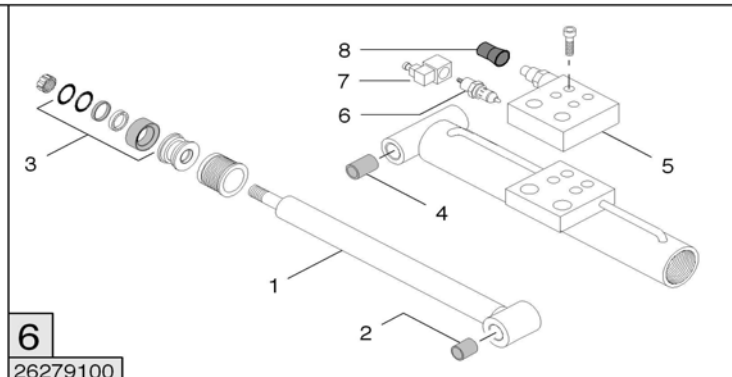
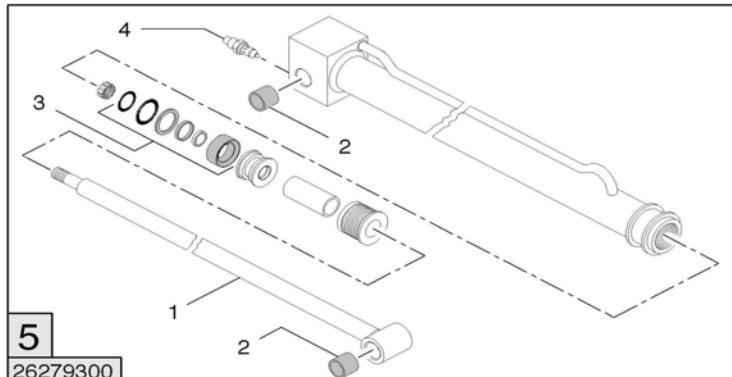



 <b>RICAMBI CILINDRI</b>  <b>RECHANGE DE CYLINDERS</b>  <b>RECAMBIO PARA LOS CILINDROS</b>				<b>CYLINDERS SPARE PARTS</b>  <b>ERSATZTEILE ZYLINDERKOMPONENTEN</b>  <b>RESERVEONDERDELEN VAN CILINDERS</b> 				
POS	Codice	Q.tà	 Descrizione	 Description	 Designation	 Benennung	 Descripción	 Beschrijving
05 01	2627930001	1 NR	STELO	ROD	TIGE	SCHAFT	VÁSTAGO	STEEL
05 02	2627930005	4 NR	BOCCOLA	BUSH	DOUILLE	BUCHSE	CASQUILLO	BUS
05 03	2627930006	1 NR	KIT GUARNIZIONI	GASKET KIT	KIT JOINTS	DICHTUNGSSATZ	KIT GUARNICIÓNES	KIT PAKKINGEN
05 04	05525600	1 NR	VALVOLA IDRAULICA	HYDRAULIC VALVE	VALVE HYDRAULIQUE	VALVE HYDRAULIQUE	VÁLVULA HIDRÁULICA	HYDRAULISCHE KLEP
06 01	2627910001	1 NR	STELO	ROD	TIGE	SCHAFT	VÁSTAGO	STEEL
06 02	2627910005	2 NR	BOCCOLA	BUSH	DOUILLE	BUCHSE	CASQUILLO	BUS
06 03	2627910007	1 NR	KIT GUARNIZIONI	GASKET KIT	KIT JOINTS	DICHTUNGSSATZ	KIT GUARNICIÓNES	KIT PAKKINGEN
06 04	2627910006	2 NR	BOCCOLA	BUSH	DOUILLE	BUCHSE	CASQUILLO	BUS
06 05	05535500	1 NR	VALVOLA IDRAULICA	HYDRAULIC VALVE	VALVE HYDRAULIQUE	VALVE HYDRAULIQUE	VÁLVULA HIDRÁULICA	HYDRAULISCHE KLEP
06 06	0553550001	1 NR	ELETTRVALVOLA	SOLENOID VALVE	ÉLECTROVANNE	MAGNETVENTIL	ELECTROVÁLVULA	ELEKTROKLEP
06 07	0552550003	1 NR	BOBINA	COIL	BOBINE	SPULE	BOBINA	SPOEL
06 08	05576200	1 NR	PROTEZIONE	PROTECTION	PROTECTION	SCHUTZ	PROTECCIÓN	BESCHERMING
07 01	2627890001	1 NR	STELO	ROD	TIGE	SCHAFT	VÁSTAGO	STEEL
07 02	2627890006	4 NR	BOCCOLA	BUSH	DOUILLE	BUCHSE	CASQUILLO	BUS
07 03	2627890005	1 NR	KIT GUARNIZIONI	GASKET KIT	KIT JOINTS	DICHTUNGSSATZ	KIT GUARNICIÓNES	KIT PAKKINGEN
08 01	2627900001	1 NR	STELO	ROD	TIGE	SCHAFT	VÁSTAGO	STEEL
08 02	2627900005	4 NR	BOCCOLA	BUSH	DOUILLE	BUCHSE	CASQUILLO	BUS









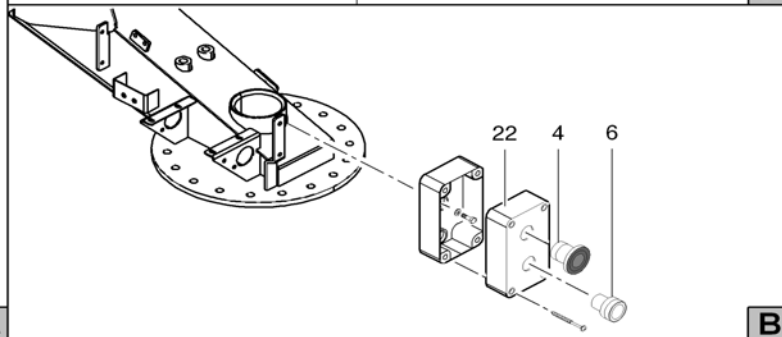
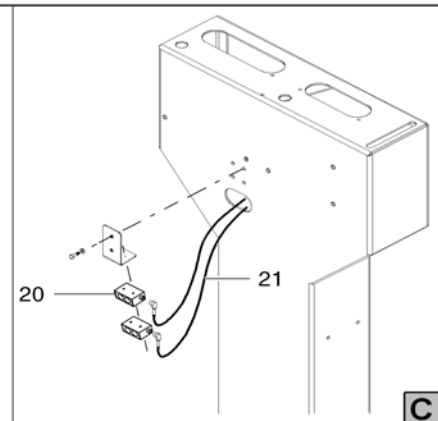
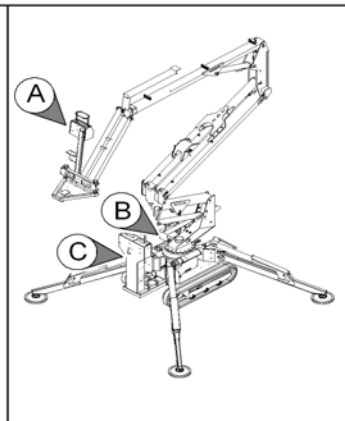
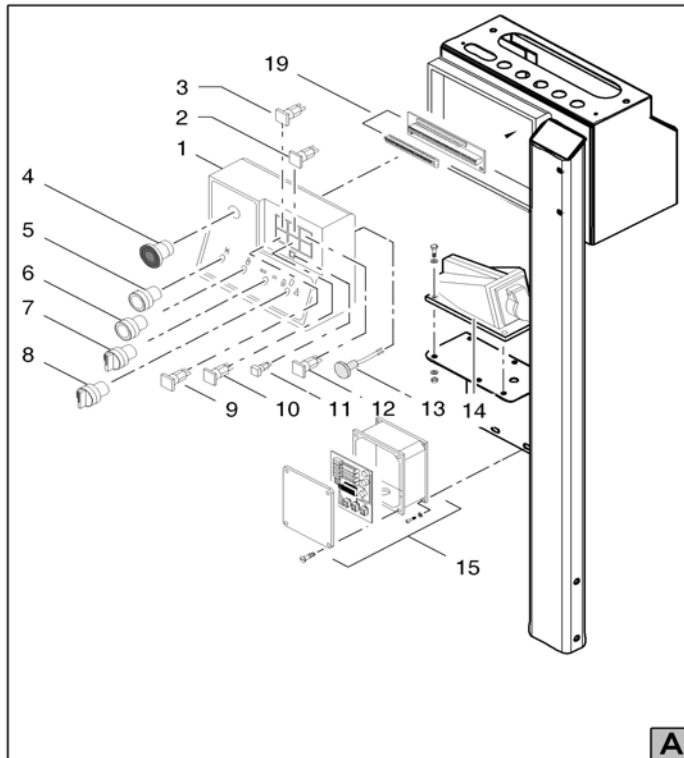



 **RICAMBI CILINDRI**  
 **RECHANGE DE CYLINDERS**  
 **RECAMBIO PARA LOS CILINDROS**

**CYLINDERS SPARE PARTS**   
**ERSATZTEILE ZYLINDERKOMPONENTEN**   
**RESERVEONDERDELEN VAN CILINDERS** 

POS	Codice	Q.tà	 Descrizione	 Description	 Designation	 Benennung	 Descripcìon	 Beschrijving
08 03	2627900006	1 NR	KIT GUARNIZIONI	GASKET KIT	KIT JOINTS	DICHTUNGSSATZ	KIT GUARNICIONES	KIT PAKKINGEN
08 04	1553870008	1 NR	VALVOLA IDRAULICA	HYDRAULIC VALVE	VALVE HYDRAULIQUE	VALVE HYDRAULIQUE	VÁLVULA HIDRÁULICA	HYDRAULISCHE KLEP
08 05	1553870009	1 NR	VALVOLA IDRAULICA	HYDRAULIC VALVE	VALVE HYDRAULIQUE	VALVE HYDRAULIQUE	VÁLVULA HIDRÁULICA	HYDRAULISCHE KLEP
08 06	05576200	1 NR	PROTEZIONE	PROTECTION	PROTECTION	SCHUTZ	PROTECCIÓN	BESCHERMING











 <b>COMPONENTI IMPIANTO ELETTRICO</b>  <b>COMPOSANTS INSTALLATION ÉLECTRIQUE</b>  <b>COMPONENTES INSTALACIÓN ELÉCTRICA</b>			<b>ELECTRICAL SYSTEM COMPONENTS</b>  <b>KOMPONENTEN ELEKTROANLAGE</b>  <b>COMPONENTEN ELEKTRISCHE INSTALLATIE</b> 					
POS	Codice	Q.tà	 Descrizione	 Description	 Designation	 Benennung	 Descripcìon	 Beschrijving
01	05520500	1 NR	SCATOLA ELETTRICA	ELECTRIC BOX	BOÎTE ÉLECTRIQUE	ELEKTROGEHÄUSE	CAJA ELÉCTRICA	ELEKTRISCH KASTJE
02	1552040003	1 NR	SPIA	PILOT LIGHT	TÉMOIN	KONTROLLLEUCHTE	INDICADOR LUMINOSO	CONTROLELAMPJE
03	1552040002	1 NR	SPIA	PILOT LIGHT	TÉMOIN	KONTROLLLEUCHTE	INDICADOR LUMINOSO	CONTROLELAMPJE
04	1556350009	1 NR	PULSANTE	BUTTON	BOUTON	DRUCKKNOPF	BOTÓN	KNOP
05	1556350067	1 NR	TAPPO	CAP	BOUCHON	VERSCHLUSS	TAPÓN	DOP
06	1556350007	1 NR	PULSANTE VERDE	BUTTON	BOUTON	DRUCKKNOPF	BOTÓN	KNOP
07	1556350010	1 NR	SELETTORE	SELECTOR	SÉLECTEUR	WÄHLSCHALTER	SELECTOR	KEUZESCHAKELAAR
08	1556350011	1 NR	SELETTORE	SELECTOR	SÉLECTEUR	WÄHLSCHALTER	SELECTOR	KEUZESCHAKELAAR
09	1552040004	1 NR	SPIA	PILOT LIGHT	TÉMOIN	KONTROLLLEUCHTE	INDICADOR LUMINOSO	CONTROLELAMPJE
10	1552040001	1 NR	SPIA	PILOT LIGHT	TÉMOIN	KONTROLLLEUCHTE	INDICADOR LUMINOSO	CONTROLELAMPJE
12	1552040005	2 NR	SPIA	PILOT LIGHT	TÉMOIN	KONTROLLLEUCHTE	INDICADOR LUMINOSO	CONTROLELAMPJE
13	25521200	1 NR	AVVISATORE ACQUSTICO	ACOUSTIC ALARM	AVERTISSEUR SONORE	HUPE	AVISADOR ACÚSTICO	AKOESTISCHE MELDER
14	1556350031	1 NR	PRESA	SOCKET	PRISE	STECKDOSE	TOMA	STOPCONTACT
15	25905800	1 NR	SCHEDA ELETTRICA	ELECTRIC BOARD	FICHE ÉLECTRIQUE	ELEKTRISCHE PLATINE	TARJETA ELÉCTRICA	ELEKTRISCHE KAART
19	1556350062	1 NR	SCHEDA	BOARD	FICHE	PLATINE	PLACA	KAART
20	1591270001	2 NR	FOTOCELLULA	PHOTOCELL	CELLULE PHOTO-ÉLECTRIQUE	PHOTOZELLE	FOTOCÉLULA	FOTOCCEL

 **COMPONENTI IMPIANTO ELETTRICO**  
 **COMPOSANTS INSTALLATION ÉLECTRIQUE**  
 **COMPONENTES INSTALACIÓN ELÉCTRICA**







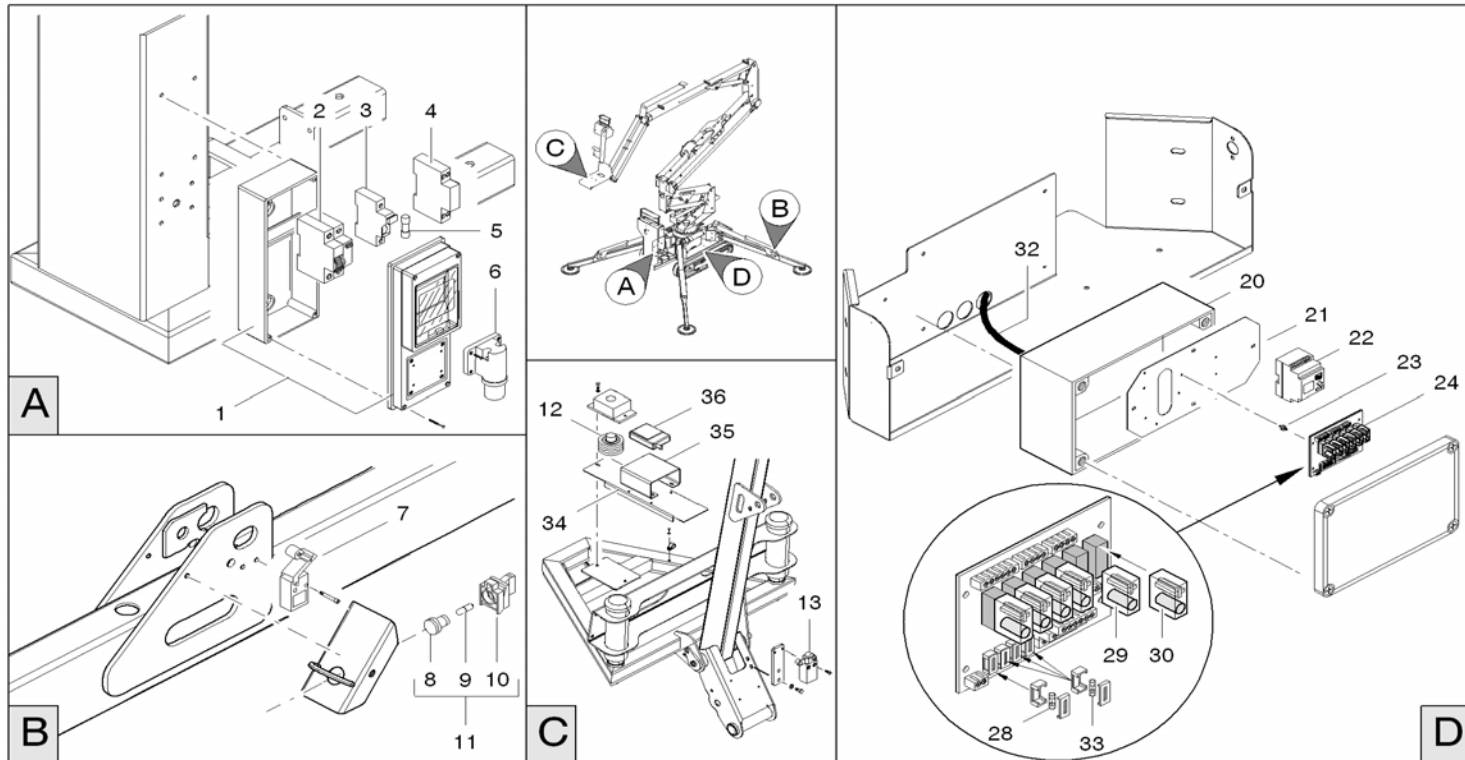





**ELECTRICAL SYSTEM COMPONENTS**   
**KOMPONENTEN ELEKTROANLAGE**   
**COMPONENTEN ELEKTRISCHE INSTALLATIE** 













POS	Codice	Q.tà	 Descrizione	 Description	 Designation	 Benennung	 Descripcìon	 Beschrijving
21	159127000101	2 NR	CAVO ELETTRICO	ELECTRIC CABLE	CÂBLE ÉLECTRIQUE	ELEKTROKABEL	CABLE ELÉCTRICO	ELEKTRISCHE KABEL
22	17044900	1 NR	SCATOLA ELETTRICA	ELECTRIC BOX	BOÎTE ÉLECTRIQUE	ELEKTROGEHÄUSE	CAJA ELÉCTRICA	ELEKTRISCH KASTJE











































 <b>COMPONENTI IMPIANTO ELETTRICO</b>  <b>COMPONENTS INSTALLACION ÉLECTRIQUE</b>  <b>COMPONENTES INSTALACIÓN ELÉCTRICA</b>				<b>ELECTRICAL SYSTEM COMPONENTS</b>  <b>KOMPONENTEN ELEKTROANLAGE</b>  <b>COMPONENTEN ELEKTRISCHE INSTALLATIE</b> 				
POS	Codice	Q.tà	 Descrizione	 Description	 Designation	 Benennung	 Descripción	 Beschrijving
01	1590900006	1 NR	SCATOLA ELETTRICA	ELECTRIC BOX	BOÎTE ÉLECTRIQUE	ELEKTROGEHÄUSE	CAJA ELÉCTRICA	ELEKTRISCH KASTJE
02	1556350015	1 NR	INTERUTTORE	SWITCH	INTERRUPTEUR	INTERRUPTORES	INTERRUPTOR	SCHAKELAARS
03	1556350016	1 NR	PORTA FUSIBILE	FUSE SUPPORT	PORTE-FUSIBLE	SICHERUNGS SOCKEL	PORTAFUSIBLE	ZEKERINGHOUDER
04	1556350017	1 NR	INTERUTTORE	SWITCH	INTERRUPTEUR	INTERRUPTORES	INTERRUPTOR	SCHAKELAARS
05	1556350033	1 NR	FUSIBILE	FUSE	FUSIBLE	SICHERUNGSDRAHT	FUSIBLE	ZEKERING
06	1556350013	1 NR	SPINA	PIN	CHEVILLE	STIF	CLAVIJA	STEKKER
07	1590900002	4 NR	MICRON	MICROSWITCH	MICROINTERRUPTEUR	MIKROSCHALTER	MICROINTERRUPTOR	MICRON
08	1556350034	1 NR	SPIA	PILOT LIGHT	TÉMOIN	KONTROLLEUCHE	INDICADOR LUMINOSO	CONTROLELAMPJE
09	1556350035	1 NR	LAMPADINA	LAMP	AMPOULE	GLÜHBIRNE	BOMBILLA	LAMP
10	1556350036	1 NR	CORPO	BODY	CORPS	GEHÄUSE	CUERPO	HOOFDDEEL
11	1556350001	4 NR	LUCE STABILIZZATORE	STABILIZER LIGHT	LUMIÈRE STABILISATEUR	ABSTÜTZUNGSBELEUCHTUNG	LUZ ESTABILIZADOR	VOLLEDIG LICHT STABILISATOR
12	25611500	1 NR	CELLA DI CARICO	LOAD CELL	CELLULE DE CHARGE	MESSDOSE	CÉLULA DE CARGA	LAADCEL
13	1556350006	1 NR	MICRON	MICROSWITCH	MICROINTERRUPTEUR	MIKROSCHALTER	MICROINTERRUPTOR	MICRON
14	05958600	5 NR	COPRI POLI	TERMINAL COVER	COUVRE-COSSES	ISOLIERKAPPEN	TAPÓN TERMINAL	AFDEKKING POLEN
15	05561800	1 NR	LAMIERA	PLATE	TÔLE	BLECH	CHAPA	STAALBLAD
16	04196900	1 NR	BATTERIA TAMPONE	BUFFER BATTERY	BATTERIE TAMPON	PUFFERBATTERIE	DE AMORTIGUAMIENTO DE LA BATERÍA	BUFFERBATTERIJ













 <b>COMPONENTI IMPIANTO ELETTRICO</b>			<b>ELECTRICAL SYSTEM COMPONENTS</b> 					
 <b>COMPOSANTS INSTALLATION ÉLECTRIQUE</b>			<b>KOMPONENTEN ELEKTROANLAGE</b> 					
 <b>COMPONENTES INSTALACIÓN ELÉCTRICA</b>			<b>COMPONENTEN ELEKTRISCHE INSTALLATIE</b> 					
POS	Codice	Q.tà	 Descrizione	 Description	 Designation	 Benennung	 Descripció	 Beschrijving
16	041969R0	1 NR	BATTERIA SECCA	DRY BATTERY	BATTERIE SANS ACIDE	BATTERIE OHNE SÄURE	BATERÍA SIN ACIDO	BATTERIJ ZONDER ZUUR
17	04774900	1 NR	STACCA BATTERIA	BATTERY CUT-OFF DEVICE	COUPE BATTERIE	BATTERIETRENNSCHALTER	CORTA-BATERÍA	ACCU-ONDERBREKER
18	05568700	1 NR	SUPPORTO	SUPPORT	SUPPORT	HALTERUNG	SOPORTE	STEUN
19	05535400	2 NR	TIRANTE	TIE ROD	TIRANT	TURMGESTÄNGE	TIRANTE	TREKSTANG
20	17049400	1 NR	SCATOLA ELETTRICA	ELECTRIC BOX	BOÎTE ÉLECTRIQUE	ELEKTROGEHÄUSE	CAJA ELÉCTRICA	ELEKTRISCH KASTJE
21	05801100	1 NR	LAMA DI FISSAGGIO	FIXING BLADE	LAME DE FIXAGE	BEFESTIGUNGSSCHI LD	LAMA FIJACIÓN	BEVESTIGINGSPLAAT
22	155635001201	1 NR	PLC	PLC	PLC	PLC	PLC	PLC
23	05971800	4 NR	ANTIVIBRANTE	ANTI-VIBRATING	ANTI - VIBRANT	VIBRATIONSDÄMPFER	ANTIVIBRANTE	ANTI-TRILELEMENT
24	1590900007	1 NR	SCHEDA ELETTRICA	ELECTRIC BOARD	FICHE ÉLECTRIQUE	ELEKTRISCHE PLATINE	TARJETA ELÉCTRICA	ELEKTRISCHE KAART
25	1556350028	1 NR	SCHEDA ELETTRONICA	ELECTRONIC BOARD	FICHE ÉLECTRONIQUE	ELEKTRONISCHE PLATINE	TARJETA ELECTRÓNICA	ELEKTRONISCHE KAART
26	1556350029	1 NR	TRASFORMATORE	TRANSFORMER	TRANSFORMATEUR	TRANSFORMATOR	TRANSFORMADOR	TRANSFORMATOR
27	1556350059	1 NR	REGOLATORE DI TENSIONE	VOLTAGE REGULATOR	RÉGULATEUR DE TENSION	SPANNUNGSREGLER	REGULADOR DE TENSIÓN	SPANNINGSREGELAAR
28	1556350025	1 NR	FUSIBILE	FUSE	FUSIBLE	SICHERUNGSDRAHT	FUSIBLE	ZEKERING 40 A
29	1556350005	5 NR	RELÈ	RELAY	RELAIS	RELAIS	RELÉ	RELAIS
30	1590900004	1 NR	RELÈ	RELAY	RELAIS	RELAIS	RELÉ	RELAIS













 <b>COMPONENTI IMPIANTO ELETTRICO</b>  <b>COMPOSANTS INSTALLATION ÉLECTRIQUE</b>  <b>COMPONENTES INSTALACIÓN ELÉCTRICA</b>			<b>ELECTRICAL SYSTEM COMPONENTS</b>  <b>KOMPONENTEN ELEKTROANLAGE</b>  <b>COMPONENTEN ELEKTRISCHE INSTALLATIE</b> 					
POS	Codice	Q.tà	 Descrizione	 Description	 Designation	 Benennung	 Descripcìon	 Beschrijving
31	03022900	1 NR	CONTAORE	HOUR METER	COMPTE-HEURES	BETRIEBSSTUNDENZ ÄHLER	CONTADOR DE HORAS	URENTELLER
32	06488500	1 NR	CAVO ELETTRICO	ELECTRIC CABLE	CÂBLE ÉLECTRIQUE	ELEKTROKABEL	CABLE ELÉCTRICO	ELEKTRISCHE KABEL
33	1556350026	3 NR	FUSIBILE	FUSE	FUSIBLE	SICHERUNGSDRAHT	FUSIBLE	ZEKERING 40 A
34	06936400	1 NR	SUPPORTO	SUPPORT	SUPPORT	HALTERUNG	SOPORTE	STEUN
35	06412400	1 NR	LAMIERA PIEGATA	FOLDED PLATE	TÔLE PLIÉE	BLECH GEBOGEN	CHAPA DOBLADA	STAALBLAD
36	27031700	1 NR	INTERUTTORE A PEDALE	FOOT SWITCH	INTERRUPTEUR	INTERRUPTORES	INTERRUPTOR	SCHAKELAARS



 <b>ADESIVI</b>  <b>AUTOCOLLANT</b>  <b>PEGATINA</b>						<b>STICKER</b>  <b>AUFKLEBER</b>  <b>ADHESIVE</b> 		
POS	Codice	Q.tà	 Descrizione	 Description	 Designation	 Benennung	 Descripción	 Beschrijving
01	07060500	2 NR	ADESIVO	STICKER	AUTOCOLLANT	AUFKLEBER	PEGATINA	ADHESIVE
02	06924300	1 NR	ADESIVO	STICKER	AUTOCOLLANT	AUFKLEBER	PEGATINA	ADHESIVE
03	1603940004	4 NR	ADESIVO	STICKER	AUTOCOLLANT	AUFKLEBER	PEGATINA	ADHESIVE
04	1603940005	2 NR	ADESIVO	STICKER	AUTOCOLLANT	AUFKLEBER	PEGATINA	ADHESIVE
05	07059200	1 NR	ADESIVO	STICKER	AUTOCOLLANT	AUFKLEBER	PEGATINA	ADHESIVE
06	06562800	1 NR	ADESIVO	STICKER	AUTOCOLLANT	AUFKLEBER	PEGATINA	ADHESIVE
06	06562900	1 NR	ADESIVO	STICKER	AUTOCOLLANT	AUFKLEBER	PEGATINA	ADHESIVE
06	06562700	1 NR	ADESIVO	STICKER	AUTOCOLLANT	AUFKLEBER	PEGATINA	ADHESIVE
06	06562600	1 NR	ADESIVO	STICKER	AUTOCOLLANT	AUFKLEBER	PEGATINA	ADHESIVE
06	06555300	1 NR	ADESIVO	STICKER	AUTOCOLLANT	AUFKLEBER	PEGATINA	ADHESIVE
06	06563000	1 NR	ADESIVO	STICKER	AUTOCOLLANT	AUFKLEBER	PEGATINA	ADHESIVE
06	06563100	1 NR	ADESIVO	STICKER	AUTOCOLLANT	AUFKLEBER	PEGATINA	ADHESIVE
08	1603940015	1 NR	ADESIVO	STICKER	AUTOCOLLANT	AUFKLEBER	PEGATINA	ADHESIVE
09	1603940016	1 NR	ADESIVO	STICKER	AUTOCOLLANT	AUFKLEBER	PEGATINA	ADHESIVE
10	1603940017	1 NR	ADESIVO	STICKER	AUTOCOLLANT	AUFKLEBER	PEGATINA	ADHESIVE
11	06039500	1 NR	ADESIVO	STICKER	AUTOCOLLANT	AUFKLEBER	PEGATINA	ADHESIVE
12	06039600	8 NR	ADESIVO	STICKER	AUTOCOLLANT	AUFKLEBER	PEGATINA	ADHESIVE

 <b>ADESIVI</b>  <b>AUTOCOLLANT</b>  <b>PEGATINA</b>			<b>STICKER</b>  <b>AUFKLEBER</b>  <b>ADHESIVE</b> 					
POS	Codice	Q.tà	 Descrizione	 Description	 Designation	 Benennung	 Descripción	 Beschrijving
13	06039700	1 NR	ADESIVO	STICKER	AUTOCOLLANT	AUFKLEBER	PEGATINA	ADHESIVE
14	06086700	2 NR	ADESIVO	STICKER	AUTOCOLLANT	AUFKLEBER	PEGATINA	ADHESIVE
15	06039900	4 NR	ADESIVO	STICKER	AUTOCOLLANT	AUFKLEBER	PEGATINA	ADHESIVE
16	06040000	2 NR	ADESIVO	STICKER	AUTOCOLLANT	AUFKLEBER	PEGATINA	ADHESIVE
17	06040100	8 NR	ADESIVO	STICKER	AUTOCOLLANT	AUFKLEBER	PEGATINA	ADHESIVE
18	06040200	1 NR	ADESIVO	STICKER	AUTOCOLLANT	AUFKLEBER	PEGATINA	ADHESIVE
19	06040300	6 NR	ADESIVO	STICKER	AUTOCOLLANT	AUFKLEBER	PEGATINA	ADHESIVE
21	06040500	2 NR	ADESIVO	STICKER	AUTOCOLLANT	AUFKLEBER	PEGATINA	ADHESIVE
23	1702155	1 NR	ADESIVO	STICKER	AUTOCOLLANT	AUFKLEBER	PEGATINA	ADHESIVE
25	06040900	2 NR	ADESIVO	STICKER	AUTOCOLLANT	AUFKLEBER	PEGATINA	ADHESIVE
26	1703814	2 NR	ADESIVO	STICKER	AUTOCOLLANT	AUFKLEBER	PEGATINA	ADHESIVE
27	1701504	1 NR	ADESIVO	STICKER	AUTOCOLLANT	AUFKLEBER	PEGATINA	ADHESIVE
28	06041200	4 NR	ADESIVO	STICKER	AUTOCOLLANT	AUFKLEBER	PEGATINA	ADHESIVE
29	06041300	4 NR	ADESIVO	STICKER	AUTOCOLLANT	AUFKLEBER	PEGATINA	ADHESIVE
30	06042400	4 NR	ADESIVO	STICKER	AUTOCOLLANT	AUFKLEBER	PEGATINA	ADHESIVE
30	06561200	4 NR	ADESIVO	STICKER	AUTOCOLLANT	AUFKLEBER	PEGATINA	ADHESIVE
31	06041500	1 NR	ADESIVO	STICKER	AUTOCOLLANT	AUFKLEBER	PEGATINA	ADHESIVE







 <b>ADESIVI</b>  <b>AUTOCOLLANT</b>  <b>PEGATINA</b>			<b>STICKER</b>  <b>AUFKLEBER</b>  <b>ADHESIVE</b> 					
POS	Codice	Q.tà	 Descrizione	 Description	 Designation	 Benennung	 Descripcìon	 Beschrijving
32	1701505	1 NR	ADESIVO	STICKER	AUTOCOLLANT	AUFKLEBER	PEGATINA	ADHESIVE
32	1701542	1 NR	ADESIVO	STICKER	AUTOCOLLANT	AUFKLEBER	PEGATINA	ADHESIVE
33	06041800	1 NR	ADESIVO	STICKER	AUTOCOLLANT	AUFKLEBER	PEGATINA	ADHESIVE
33	07034200	1 NR	ADESIVO	STICKER	AUTOCOLLANT	AUFKLEBER	PEGATINA	ADHESIVE
34	06041900	1 NR	ADESIVO	STICKER	AUTOCOLLANT	AUFKLEBER	PEGATINA	ADHESIVE
35	06042000	1 NR	ADESIVO	STICKER	AUTOCOLLANT	AUFKLEBER	PEGATINA	ADHESIVE
36	06042100	1 NR	ADESIVO	STICKER	AUTOCOLLANT	AUFKLEBER	PEGATINA	ADHESIVE
37	07060600	2 NR	ADESIVO	STICKER	AUTOCOLLANT	AUFKLEBER	PEGATINA	ADHESIVE
38	1704277	2 NR	ADESIVO	STICKER	AUTOCOLLANT	AUFKLEBER	PEGATINA	ADHESIVE
40	06044000	4 NR	ADESIVO	STICKER	AUTOCOLLANT	AUFKLEBER	PEGATINA	ADHESIVE
43	06056300	1 NR	ADESIVO	STICKER	AUTOCOLLANT	AUFKLEBER	PEGATINA	ADHESIVE
45	07056600	2 NR	ADESIVO IT	STICKER IT	AUTOCOLLANT IT	AUFKLEBER IT	PEGATINA IT	ADHESIVE IT
46	07064500	1 NR	ADESIVO IT	STICKER IT	AUTOCOLLANT IT	AUFKLEBER IT	PEGATINA IT	ADHESIVE IT
47	06462900	2 NR	ADESIVO	STICKER	AUTOCOLLANT	AUFKLEBER	PEGATINA	ADHESIVE
47	06463000	2 NR	ADESIVO	STICKER	AUTOCOLLANT	AUFKLEBER	PEGATINA	ADHESIVE
47	06462800	2 NR	ADESIVO	STICKER	AUTOCOLLANT	AUFKLEBER	PEGATINA	ADHESIVE
47	06462700	2 NR	ADESIVO	STICKER	AUTOCOLLANT	AUFKLEBER	PEGATINA	ADHESIVE

 <b>ADESIVI</b>  <b>AUTOCOLLANT</b>  <b>PEGATINA</b>						<b>STICKER</b>  <b>AUFKLEBER</b>  <b>ADHESIVE</b> 		
POS	Codice	Q.tà	 Descrizione	 Description	 Designation	 Benennung	 Descripcìon	 Beschrijving
47	06448200	2 NR	ADESIVO	STICKER	AUTOCOLLANT	AUFKLEBER	PEGATINA	ADHESIVE
47	06463100	2 NR	ADESIVO	STICKER	AUTOCOLLANT	AUFKLEBER	PEGATINA	ADHESIVE
47	06463200	2 NR	ADESIVO	STICKER	AUTOCOLLANT	AUFKLEBER	PEGATINA	ADHESIVE
48	06462300	2 NR	ADESIVO	STICKER	AUTOCOLLANT	AUFKLEBER	PEGATINA	ADHESIVE
48	06462400	2 NR	ADESIVO	STICKER	AUTOCOLLANT	AUFKLEBER	PEGATINA	ADHESIVE
48	06462200	2 NR	ADESIVO	STICKER	AUTOCOLLANT	AUFKLEBER	PEGATINA	ADHESIVE
48	06462100	2 NR	ADESIVO	STICKER	AUTOCOLLANT	AUFKLEBER	PEGATINA	ADHESIVE
48	06448100	2 NR	ADESIVO	STICKER	AUTOCOLLANT	AUFKLEBER	PEGATINA	ADHESIVE
48	06462500	2 NR	ADESIVO	STICKER	AUTOCOLLANT	AUFKLEBER	PEGATINA	ADHESIVE
48	06462600	2 NR	ADESIVO	STICKER	AUTOCOLLANT	AUFKLEBER	PEGATINA	ADHESIVE
50	07056700	2 NR	ADESIVO	STICKER	AUTOCOLLANT	AUFKLEBER	PEGATINA	ADHESIVE
51	1701499	2 NR	ADESIVO	STICKER	AUTOCOLLANT	AUFKLEBER	PEGATINA	ADHESIVE
53	06232100	1 NR	ADESIVO	STICKER	AUTOCOLLANT	AUFKLEBER	PEGATINA	ADHESIVE
54	06165000	1 NR	ADESIVO	STICKER	AUTOCOLLANT	AUFKLEBER	PEGATINA	ADHESIVE
55	1603940024	1 NR	ADESIVO DE	STICKER DE	AUTOCOLLANT DE	AUFKLEBER DE	PEGATINA DE	ADHESIVE DE
55	1603940027	1 NR	ADESIVO ES	STICKER ES	AUTOCOLLANT ES	AUFKLEBER ES	PEGATINA ES	ADHESIVE ES
55	1603940019	1 NR	ADESIVO FR	STICKER FR	AUTOCOLLANT FR	AUFKLEBER FR	PEGATINA FR	ADHESIVE FR



 **ADESIVI**  
 **AUTOCOLLANT**  
 **PEGATINA**

**STICKER**   
**AUFKLEBER**   
**ADHESIVE** 

POS	Codice	Q.tà	 Descrizione	 Description	 Designation	 Benennung	 Descripcìon	 Beschrijving
55	1603940026	1 NR	ADESIVO	STICKER	AUTOCOLLANT	AUFKLEBER	PEGATINA	ADHESIVE
55	1603940025	1 NR	ADESIVO IT	STICKER IT	AUTOCOLLANT IT	AUFKLEBER IT	PEGATINA IT	ADHESIVE IT
55	1603940014	1 NR	ADESIVO NL	STICKER NL	AUTOCOLLANT NL	AUFKLEBER NL	PEGATINA NL	ADHESIVE NL
55	1603940028	1 NR	ADESIVO	STICKER	AUTOCOLLANT	AUFKLEBER	PEGATINA	ADHESIVE
56	1603940013	1 NR	ADESIVO	STICKER	AUTOCOLLANT	AUFKLEBER	PEGATINA	ADHESIVE
57	1706898	2 NR	ADESIVO	STICKER	AUTOCOLLANT	AUFKLEBER	PEGATINA	ADHESIVE
58	06068600	1 NR	ADESIVO	STICKER	AUTOCOLLANT	AUFKLEBER	PEGATINA	ADHESIVE
60	1001125483	3 NR	ADESIVO	STICKER	AUTOCOLLANT	AUFKLEBER	PEGATINA	ADHESIVE
62	1706493	1 NR	ADESIVO	STICKER	AUTOCOLLANT	AUFKLEBER	PEGATINA	ADHESIVE
63	1705828	1 NR	ADESIVO	STICKER	AUTOCOLLANT	AUFKLEBER	PEGATINA	ADHESIVE
64	1706098	1 NR	ADESIVO	STICKER	AUTOCOLLANT	AUFKLEBER	PEGATINA	ADHESIVE
65	07050700	2 NR	ADESIVO	STICKER	AUTOCOLLANT	AUFKLEBER	PEGATINA	ADHESIVE
66	07060900	2 NR	ADESIVO	STICKER	AUTOCOLLANT	AUFKLEBER	PEGATINA	ADHESIVE





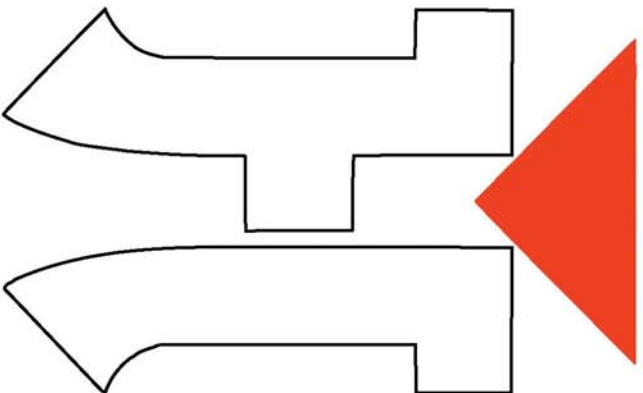

**HINOWA SPA.**  
Via Fontana 37054 NOGARA (VR) - Italy  
Tel. +39 0442 539100 Fax +39 0442 539075  
E-mail: [hinowa@hinowa.it](mailto:hinowa@hinowa.it) Web site: [www.hinowa.com](http://www.hinowa.com)  
Marketing: [info@hinowa.com](mailto:info@hinowa.com)



An Oshkosh Corporation Company

**Corporate Office**  
**JLG Industries, Inc.**  
**1 JLG Drive**  
**McConnellsburg, PA 17233-9533 USA**  
**☎ (717) 485-5161 (Corporate)**  
**☎ (877) 554-5438 (Customer Support)**  
**📠 (717) 485-6417**

**Visit our website for JLG Worldwide Locations.**  
**[www.jlg.com](http://www.jlg.com)**