



An Oshkosh Corporation Company

Illustrated Parts Manual

Compact Crawler

X26JP/3

X770AJ/3



3121747
October 7, 2018 - Rev B

 SOTTOCARRO CINGOLATO

RAUPENFAHRWERH 

 TRACKED UNDERCARRIAGE

CARRO DE ORUGAS 



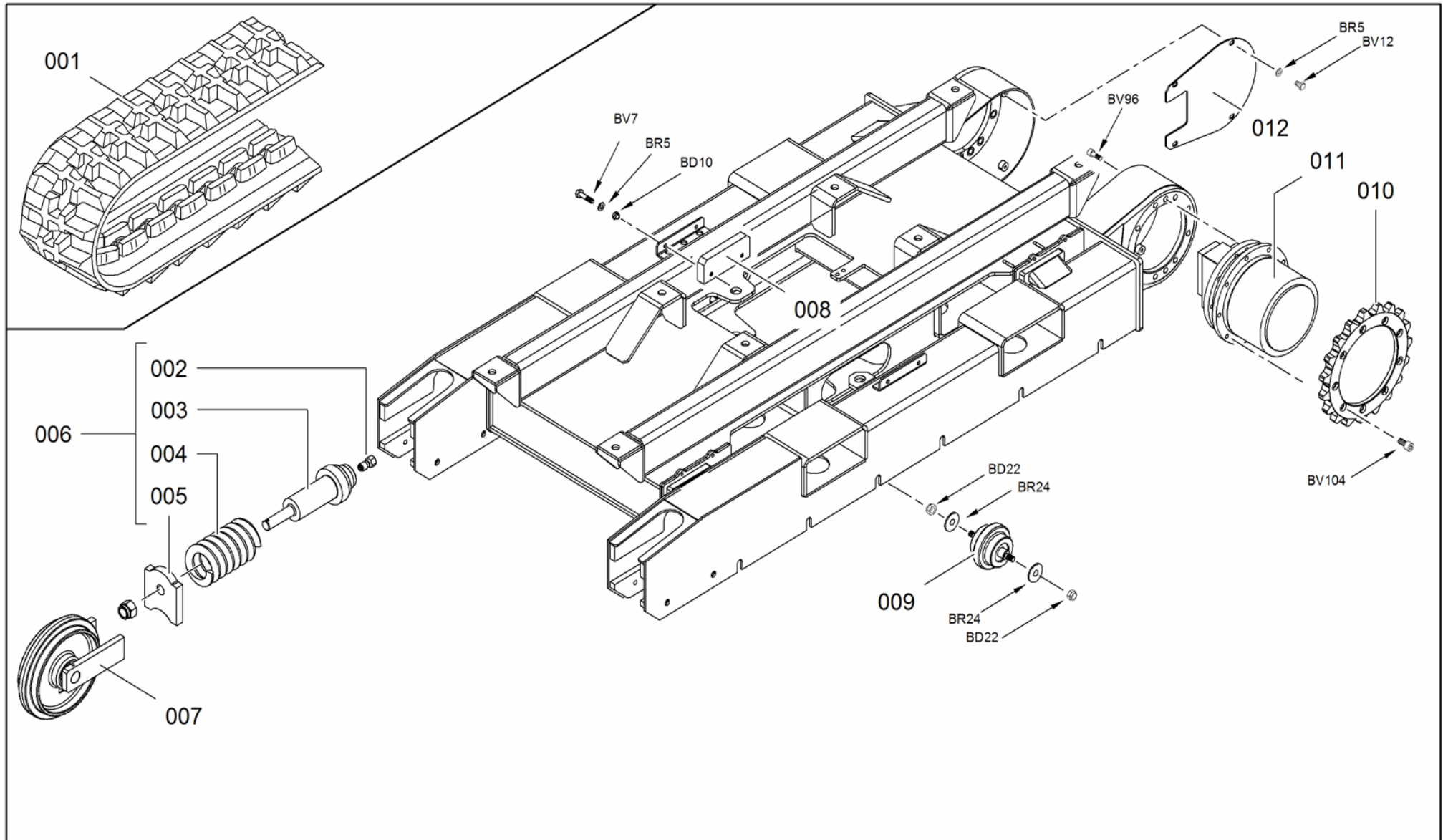

 CHENILLARD



 SOTTOCARRO CINGOLATO

 RAUPENFAHRWERH 
 TRACKED UNDERCARRIAGE

 CARRO DE ORUGAS 
 CHENILLARD

POS Codice	Q.tà	 Descrizione	 Description	 Designation	 Benennung	 Descripción
1 2758990B	2 NR	CINGOLO NO MARKING	RUBBER TRACK NO MARKING	CHENILLE NON MARQUANTE	NICHT MARKIERENDE RAUPENKETTE	ORUGA BLANCA
2 03149200	1 NR	VALVOLA IDRAULICA	HYDRAULIC VALVE	VALVE HYDRAULIQUE	HYDRAULIKVENTIL	VÁLVULA HIDRÁULICA
3 14265800	1 NR	CILINDRO TENDICINGOLO COMPLETO	CYLINDER	CYLINDRE	ZYLINDER	CILINDRO
4 04274100	1 NR	MOLLA TENDICINGOLO	SPRING	RESSORT	KETTENSANNFEDER	MUELLE
5 07610700	1 NR	PIASTRA	PLATE	PLAQUE	PLATTE	PLACA
6 175898H2	2 NR	SUPPORTO TENDICINGOLO	IDLER SUPPORT	SUPPORT TENDEUR CHENILLE	KETTENSANNHALTERUNG	SOPORTE TENSOR ORUGA
7 175983H2	2 NR	RUOTA TENDICINGOLO	IDLER WHEEL	ROUE TENDEUR DE CHENILLE	KETTENSANNRAD	RUEDA TENSOR ORUGA
8 04463500	2 NR	GUIDACINGOLO	TRACK'S GUIDE	GUIDAGE CHENILLE	BAHN FÜR DIE KETTE	GUIA ORUGA
9 147310H2	12 NR	RULLO INFERIORE	CARRIER ROLLER	ROULEAU INFÉRIEUR	TRAGROLLE	RODILLO INFERIOR
10 055609H2	2 NR	RUOTA DI TRAZIONE	SPROCKET WHEEL	ROUE DE TRACTION	ANTRIEBSRAD	RUEDA DE ARRASTRE
11 264491H2	2 NR	MOTORIDUTTORE	GEAR MOTOR	MOTORÉDUCTEUR	GETRIEBEMOTOR	MOTORREDUCTOR

 SOTTOCARRO CINGOLATORAUPENFAHRWERH  TRACKED UNDERCARRIAGECARRO DE ORUGAS  CHENILLARD

POS Codice	Q.tà	 Descrizione	 Description	 Designation	 Benennung	 Descripcìon
12 063949H2	2 NR	COPERCHIO	COVER	COUVERCLE	DECKEL	TAPA

 ALLARGAMENTO IDRAULICO

HYDR. SPURWEITENVER STELLEINRICHTUNG 

 HYDRAULIC EXTENSION

EXTENSION HIDRAULICA 



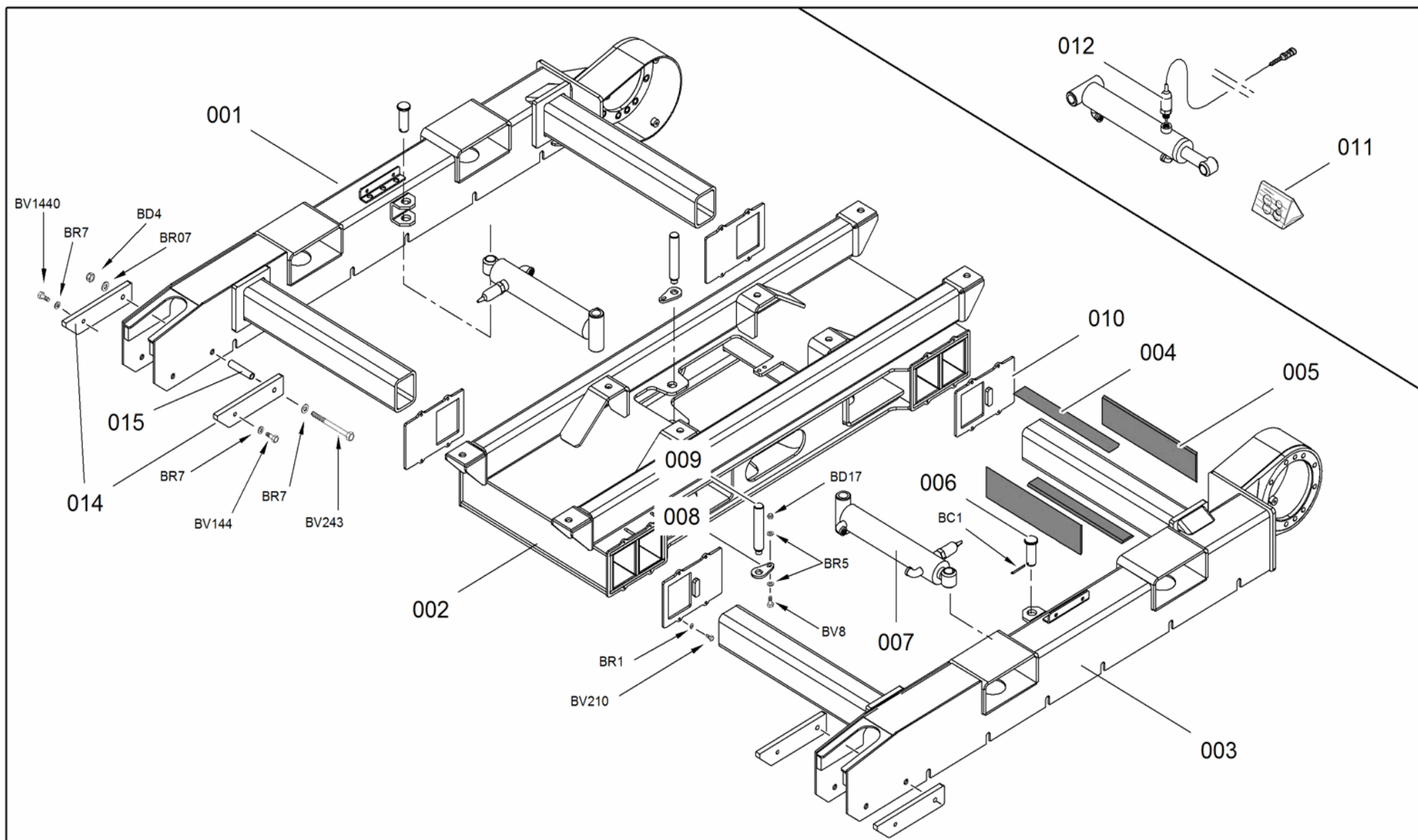

 ECARTEMENT HYDRAULIQUE



 ALLARGAMENTO IDRAULICO

 HYDR. SPURWEITENVER STELLEINRICHTUNG 
 HYDRAULIC EXTENSION





 EXTENSION HIDRAULICA 
 ECARTEMENT HYDRAULIQUE

POS Codice	Q.tà	 Descrizione	 Description	 Designation	 Benennung	 Descripción
1 375181H2	1 NR	ASSIEME LONGHERONE DESTRO	RIGHT SIDE FRAME ASSEMBLY	ENSEMBLE CHÂSSIS LATÉRAL LONGERON DROIT	FAHRSCHIFF RECHTS	ORUGA DERECHA
2 374942H2	1 NR	STRUTTURA CENTRALE SOTTOCARRO	CENTRAL STRUCTURE UNDERCARRIAG E	STRUCTURE CENTRALE DU CHENILLARD	ZENTRALSTRUKT UR DES FAHRWERKS	ESTRUCTURA CENTRAL CARRO DE ORUGAS
3 375182H2	1 NR	ASSIEME LONGHERONE SINISTRO	LEFT SIDE FRAME ASSEMBLY	ENSEMBLE CHÂSSIS LATÉRAL LONG. GAUCHE	FAHRSCHIFF LINKS	ORUGA IZQUIERDA
4 06406700	8 NR	GUIDA ALLARGAMENTO	EXPANSION GUIDE	GLISSIÈRE ÉLARGISSEMENT	FÜHRUNGSVERB REITERUNG	GUÍA DE EXTENSIÓN
5 07589500	8 NR	GUIDA ALLARGAMENTO	EXPANSION GUIDE	GLISSIÈRE ÉLARGISSEMENT	GLEITFÜHRUNG SPURVERBREITE RUNG	GUÍA DE EXTENSIÓN
6 04256300	2 NR	SPINA	PIN	CHEVILLE	STIFT	CLAVIJA
7 274943H2	2 NR	CILINDRO ALLARGAMENTO SOTTOCARRO	UNDERCARRIAG E WIDENING CYLINDER	VERIN ELARGISSEMENT	SPURVERBREITE RUNGSZYLINDER	CILINDRO ENSANCHAMIENT O
9 07517900	2 NR	SPINA	PIN	AXE	STIFT	CLAVIJA

 ALLARGAMENTO IDRAULICO

 HYDR. SPURWEITENVER STELLEINRICHTUNG 
 HYDRAULIC EXTENSION

 EXTENSION HIDRAULICA 
 ECARTEMENT HYDRAULIQUE

POS Codice	Q.tà	 Descrizione	 Description	 Designation	 Benennung	 Descripcìon
10 374937H2	4 NR	COPERCHIO GUIDE ALLARGAMENTO	EXPANSION GUIDE COVER	COUVERCLE GLISSIÈRE ELARGISSEMENT	DECKEL GLEITFÜHRUNG	TAPA GUÍA ENSANCHAMIENT O
11 2749430001	1 NR	KIT GUARNIZIONI CILINDRO ALLARGAMENTO SOTTOCARRO LL2614-X26JP-X7 70AJ	SEAL KIT	KIT DE JOINTS	DICHTSATZ	KIT JUNTAS
12 17329500	2 NR	MICROINTERRUTT ORE ALLARGAMENTO CARRO N/O COMPLETO DI CAVO E CONNETTORE	WIDENING SYSTEM MICRO SWITCH N/O CONTACT WITH CABLE AND CONNECTOR	MICRO INTERRUPTEUR ELARGISSEMENT AVEC CABLE ET CONNECTEUR	MIKROSCHALTER SPURVERBREITE RUNG MIT KABEL UND STECKER	MICROINTERRUP TOR ENSANCHAMIENT O CON CABLE Y CONECTOR
14 075194H2	4 NR	PIASTRA	PLATE	PLAQUE	PLATTE	PLACA
15 07610500	2 NR	DISTANZIALE	SPACER	ENTRETOISE	ABSTANDHALTE R	ESPACIADOR

 BASE TORRETTA

ARBEITSTURM 

 TURRET BASE

BASE TORRETTA GIRATORIA 



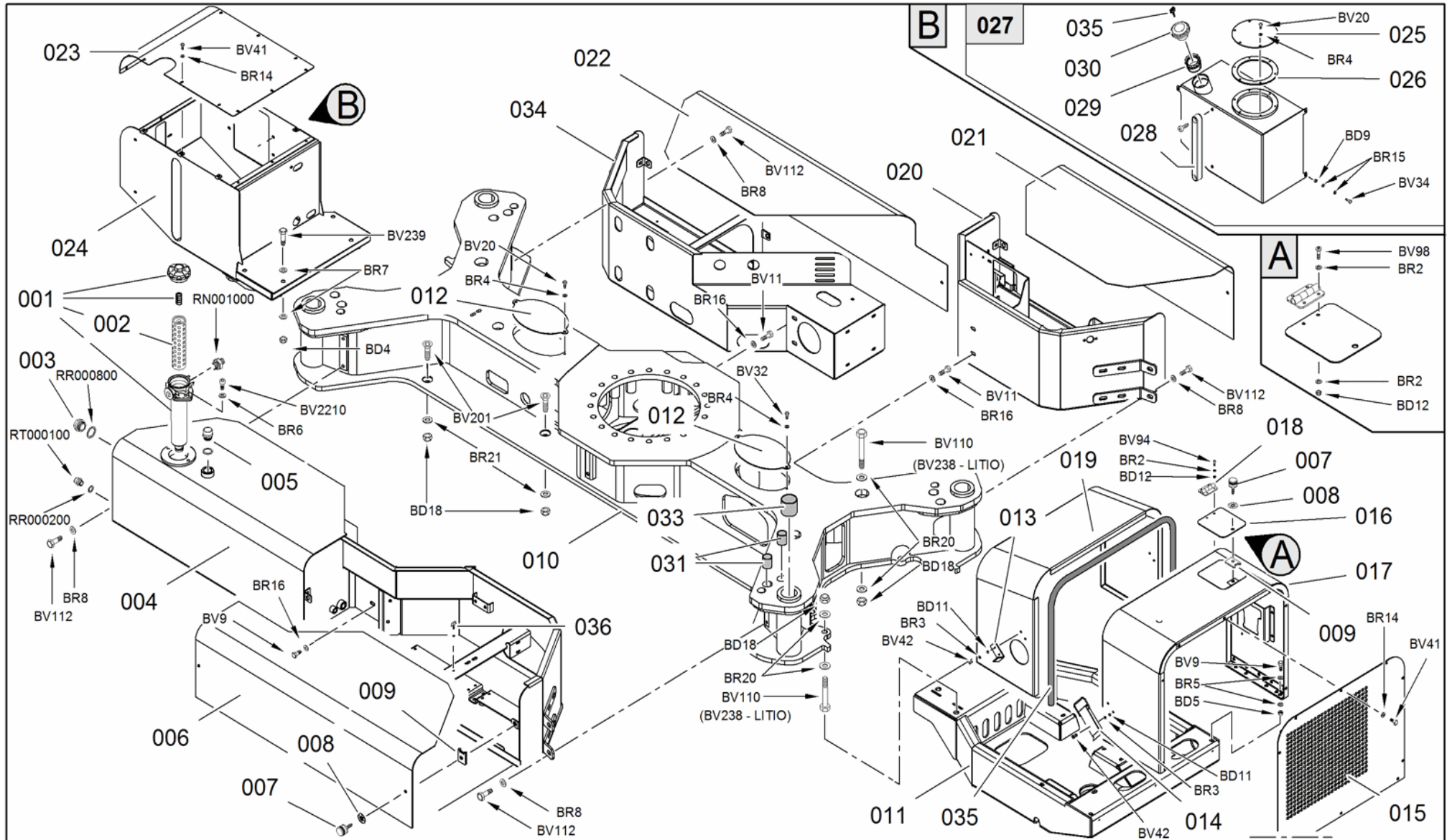

 BASE TOURELLE







 BASE TORRETTA
ARBEITSTURM 
 TURRET BASE
BASE TORRETTA GIRATORIA 
 BASE TOURELLE

POS Codice	Q.tà	 Descrizione	 Description	 Designation	 Benennung	 Descripcìon
1 15120100	1 NR	FILTRO OLIO IDRAULICO COMPLETO	COMPLETE HYDRAULIC OIL FILTER	FILTRE À HUILE	HYDARULIKÖLFILTER	FILTRO ACEITE HIDRÁULICO
2 05120200	1 NR	CARTUCCIA FILTRO OLIO IDRAULICO	OIL FILTER INSERT	CARTOUCHE FILTRE À HUILE	ÖLFILTEREINSATZ	CARTUCHO FILTRO ACEITE
3 05061800	1 NR	LIVELLO OLIO	OIL LEVEL	NIVEAU HUILE	ÖLSTAND	NIVEL ACEITE
4 174930J2	1 NR	SERBATOIO OLIO COMPLETO	OIL TANK COMPLETE	RESERVOIR HUILE	ÖLTANK	DEPOSITO ACEITE
5 05611800	1 NR	TAPPO OLIO	OIL PLUG	BOUCHON D'HUILE	ÖLDECKEL	TAPÓN ACEITE
6 075800J2	1 NR	COPERCHIO	COVER	COUVERCLE	DECKEL	TAPA
7 07343200	8 NR	VITE IMPERDIBILE ZIGRINATA CORTA	SHORT IMPERDIBLE KNURLED SCREW	VIS IMPERDABLE	SCHRAUBE	TORNILLO IMPERDIBLE
7 07343200	1 NR	VITE IMPERDIBILE ZIGRINATA CORTA	SHORT IMPERDIBLE KNURLED SCREW	VIS IMPERDABLE	SCHRAUBE	TORNILLO IMPERDIBLE





 BASE TORRETTA
ARBEITSTURM 
 TURRET BASE
BASE TORRETA GIRATORIA 
 BASE TOURELLE

POS Codice	Q.tà	 Descrizione	 Description	 Designation	 Benennung	 Descripción
8 07343400	8 NR	AGGANCI PER VITE IMPERDIBILE	COUPLING FOR IMPERDIBLE SCREW	CROCHET VIS IMPERDABLE	HAKEN FÜR SCHRAUBE	GANCHO TORNILLO IMPERDIBLE
8 07343400	1 NR	AGGANCI PER VITE IMPERDIBILE	COUPLING FOR IMPERDIBLE SCREW	CROCHET VIS IMPERDABLE	HAKEN FÜR SCHRAUBE	GANCHO TORNILLO IMPERDIBLE
9 07343300	8 NR	RICETTACOLO PER VITE IMPERDIBILE	RECEPTACLE FOR IMPERDIBLE SCREW	PRISE DE VIS POUR VIS IMPERDABLE	AUFNAHME FÜR SCHRAUBE	REFUGIO TORNILLO IMPERDIBLE
9 07343300	1 NR	RICETTACOLO PER VITE IMPERDIBILE	RECEPTACLE FOR IMPERDIBLE SCREW	PRISE DE VIS POUR VIS IMPERDABLE	AUFNAHME FÜR SCHRAUBE	REFUGIO TORNILLO IMPERDIBLE
10 174927H2	1 NR	BASE PIATTAFORMA	PLATFORM BASE	BASE PLATEFORME	ARBEITSBÜHNEN UNTERGESTELL	BASE PLATAFORMA
11 374933J2	1 NR	SUPPORTO MOTORE DIESEL	DIESEL ENGINE SUPPORT	SUPPORT MOTEUR DIESEL	DIESEL MOTORHALTERUNG	SUPORTE MOTOR DIESEL
11 376952D1	1 NR	SUPPORTO COMPONENTI ELETTRICI	ELECTRIC COMPONENT SUPPORT	SUPPORT COMPOSANTS ÉLECTRIQUES	HALTERUNG E-TEILE	SOPORTE COMPONENTES ELÉCTRICOS
12 075999H2	2 NR	CARTER	PROTECTION	PROTECTION	SCHUTZ	PROTECCIÓN
13 05442500	2 NR	RISCONTRO	FASTENER LOCATOR	PLAQUE POUR AGRAFAGE	ANSCHLAG	GANCHO
14 05442600	2 NR	CHIUSURA A GANCIO	HOO FASTENING	FERMETURE À CROCHET	HAKENVERSCHLUSS	GANCHO DE CIERRE

 BASE TORRETTA
ARBEITSTURM 
 TURRET BASE
BASE TORRETTA GIRATORIA 
 BASE TOURELLE

POS Codice	Q.tà	 Descrizione	 Description	 Designation	 Benennung	 Descripción
15 374935J2	1 NR	COVER	COVER	COUVERCLE	DECKEL	TAPA
16 075705J2	1 NR	COVER	COVER	COUVERCLE	DECKEL	TAPA
17 374934J2	1 NR	PROTEZIONE FISSA MOTORE DIESEL	DIESEL ENGINE PROTECTION	PROTECTION MOTEUR DIESEL	DIESEL MOTORSCHUTZ	PROTECCIÓN MOTOR DIESEL
18 07189900	1 NR	CERNIERA A OSCILLAZIONE LIBERA	HINGE SWING FREE	CHARNIÈRE	SCHARNIER	BISAGRA
18 07189900	2 NR	CERNIERA A OSCILLAZIONE LIBERA	HINGE SWING FREE	CHARNIÈRE	SCHARNIER	BISAGRA
19 374936J2	1 NR	PROTEZIONE RIMOVIBILE MOTORE DIESEL	REMOVABLE PROTECTION DIESEL ENGINE	PROTECTION MOTEUR DIESEL	DIESEL MOTORSCHUTZ	PROTECCIÓN DESMONTABLE MOTOR DIESEL
20 377077J2	1 NR	SCATOLA COMPONENTI ELETTRICI SALDATA	ELECTRICAL COMPONENTS SEALED BOX	COMPOSANTS ÉLECTRIQUES BOÎTE SCELLÉE	ELEKTROKOMPO NENTEN SEALED BOX	COMPONENTES ELÉCTRICOS CAJA SELLADA
21 075820J2	1 NR	COVER	COVER	COUVERCLE	DECKEL	TAPA
22 075827J2	1 NR	COPERCHIO	COVER	COUVERCLE	DECKEL	TAPA
23 076006J2	1 NR	COVER	COVER	COUVERCLE	DECKEL	TAPA
23 076083J2	1 NR	COPERTURA	COVER	COUVERTURE	DECKUNG	COBERTURA

 BASE TORRETTA
ARBEITSTURM 
 TURRET BASE
BASE TORRETA GIRATORIA 
 BASE TOURELLE

POS Codice	Q.tà	 Descrizione	 Description	 Designation	 Benennung	 Descripción
24 376015J2	1 NR	SUPPORTO SERBATOIO	TANK SUPPORT	SUPPORT RESERVOIR	TANK HALTERUNG	SOPORTE DEPOSITO
24 376081J2	1 NR	PORTAOGGETTI LL2614 LITIO	GLOVE COMPARTMENT LL2614 LITHIUM	BOÎTE À GANTS	HANDSCHUHFAC H	GUANTERA
25 07600900	1 NR	COVER	COVER	COUVRCLE	DECKEL	TAPA
26 07421600	1 NR	GUARNIZIONE BOCCHETTONE SERBATOIO GASOLIO	SEAL OIL TANK CAP	JOINT CAPUCHON RÉSERVOIR DIESEL	DICHTUNG DECKEL ÖLTANK	GUARNICIÓN TAPA DEPÓSITO DIESEL
27 174938H3	1 NR	SERBATOIO GASOLIO	DIESEL TANK	RÉSERVOIR DE GASOIL	DIESELTANK	DEPÓSITO DE GASÓLEO
28 27600000	1 NR	LIVELLO GASOLIO	DIESEL LEVEL	NIVEAU GASOIL	DIESEL STAND	NIVEL GASOIL
30 25731300	1 NR	TAPPO	CAP	BOUCHON	VERSCHLUSS	TAPÓN
31 07599700	8 NR	BOCCOLA	BUSH	DOUILLE	BUCHSE	CASQUILLO
33 07256800	8 NR	BOCCOLA	BUSH	DOUILLE	BUCHSE	CASQUILLO
34 374932J2	1 NR	SCATOLA MOTORE ELETTRICO	BOX	BOITE	GEHÄUSE	CAJA
35 05656400	1 NR	CHIAVE TAPPO DIESEL	KEY DIESEL CAP	CLÉ	SCHLÜSSEL	LLAVE

 BASE TORRETTA COMPONENTI ELETTRICI

BASE FRAME ELECTRICAL COMPONENTS 



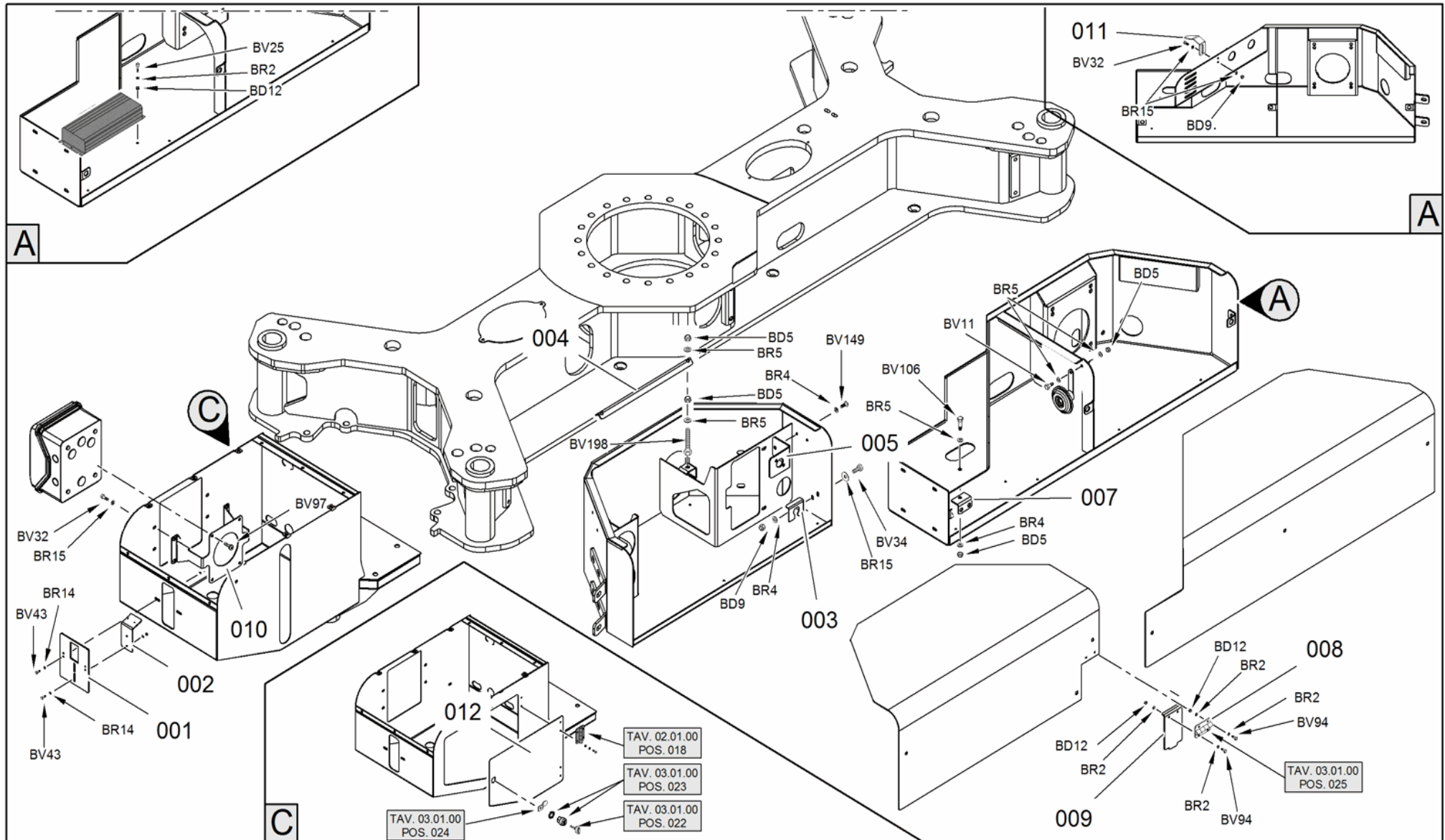

 CHASSIS ELECTRICAL COMPONENTS

FRAME BASE COMPONENTES ELÉCTRICOS 

 COMPOSANTS ÉLECTRIQUES BASE FRAME



 BASE TORRETTA COMPONENTI ELETTRICI
BASE FRAME ELECTRICAL COMPONENTS 
 CHASSIS ELECTRICAL COMPONENTS
FRAME BASE COMPONENTES ELÉCTRICOS 
 COMPOSANTS ÉLECTRIQUES BASE FRAME

POS Codice	Q.tà	 Descrizione	 Description	 Designation	 Benennung	 Descripción
1 061187Y1	1 NR	PIASTRA	PLATE	PLAQUE	PLATTE	PLACA
2 076071Y1	1 NR	LAMIERA PIEGATA	FOLDED PLATE	TÔLE PLIÉE	BLECH	CHAPA DOBLADA
4 075822Y1	1 NR	PIEGATO FISSAGGIO BATTERIA	FOLDED BATTERY FIXING	SUPPORT BATTERIE	BATTERIEHALTE RUNG	SOPORTE BATERÍA
5 074167Y1	1 NR	PIEGATO PER STACCABATTERI A MK2 (FROM C170000893)	SUPPORT FOR BATTERY CUTOFF MK2 (FROM C170000893)	SUPPORT POUR COUPE BATTERIE MK2 (FROM C170000893)	HALTERUNG FÜR BATTERIETRENN SCHALTER MK2 (FROM C170000893)	SOPORTE PARA DESCONECTADO R DE BATERÍA MK2 (FROM C170000893)
7 055629H3	1 NR	STAFFA	BRACKET	ÉTRIER	HALTEBÜGEL	ESTRIBO
8 07178700	3 NR	CERNIERA CON CONTROLLO DELLA POSIZIONE	HINGES WITH POSITION CONTROL	CHARNIÈRE	SCHARNIER	BISAGRA
8 07178700	4 NR	CERNIERA CON CONTROLLO DELLA POSIZIONE	HINGES WITH POSITION CONTROL	CHARNIÈRE	SCHARNIER	BISAGRA
8 07178700	1 NR	CERNIERA CON CONTROLLO DELLA POSIZIONE	HINGES WITH POSITION CONTROL	CHARNIÈRE	SCHARNIER	BISAGRA
9 075821J2	1 NR	COPERCHIO	COVER	COUVERCLE	DECKEL	TAPA





 BASE TORRETTA COMPONENTI ELETTRICI

BASE FRAME ELECTRICAL COMPONENTS 

 CHASSIS ELECTRICAL COMPONENTS

FRAME BASE COMPONENTES ELÉCTRICOS 

 COMPOSANTS ÉLECTRIQUES BASE FRAME

POS Codice	Q.tà	 Descrizione	 Description	 Designation	 Benennung	 Descripción
10 076007Y1	1 NR	SUPPORTO	SUPPORT	SUPPORT	HALTERUNG	SOPORTE
11 076087D2	1 NR	INDICE ALLINEAMENTO	ALIGNMENT INDICATOR	INDICATEUR D'ALIGNEMENT	AUSRICHTUNGS- ANZEIGE	INDICADOR ALINEACIÓN
12 076084J2	1 NR	PORTELLO	HATCH	GUICHET	ABDECKPLATTE	PORTILLA

 SUPPORTO BRACCI

 ARMS SUPPORT

 SUPPORT BRAS

ARMEHALTERUNG 



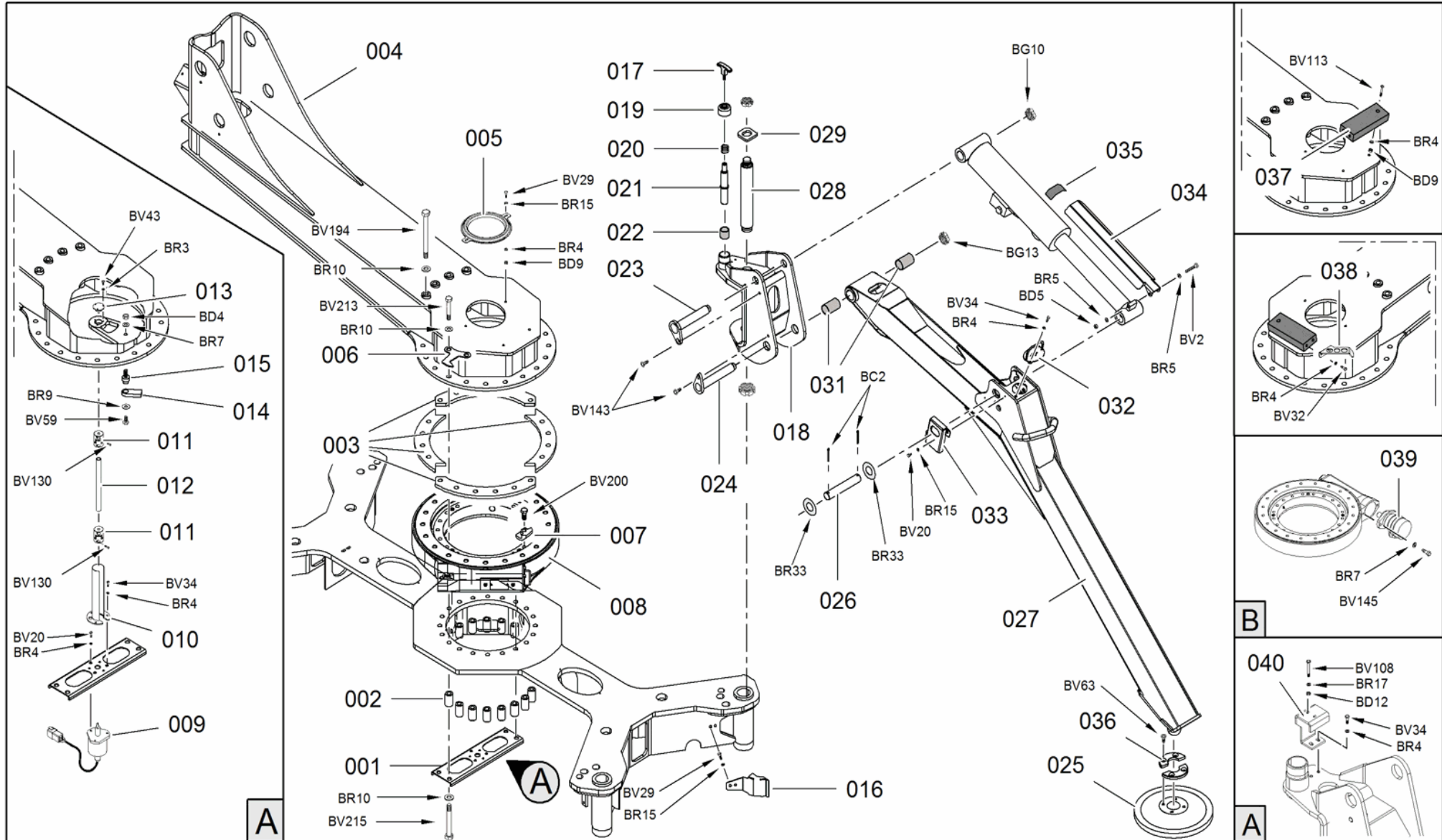

SOPORTE BRAZOS 







 SUPPORTO BRACCI

 ARMEHALTERUNG 
 ARMS SUPPORT

 SOPORTE BRAZOS 
 SUPPORT BRAS

POS Codice	Q.tà	 Descrizione	 Description	 Designation	 Benennung	 Descripción
1 067463Y1	1 NR	SUPPORTO	SUPPORT	SUPPORT	HALTERUNG	SOPORTE
2 06551600	20 NR	PINZA	PLIERS	PINCE	KLEMME	PINZA
3 176090Y1	1 NR	KIT 4 SPESSORI FISSAGGIO SUPPORTO BRACCI 15MM CATAFORESI	KIT 4 THICKNESSES FIXING SUPPORT ARMS 15MM	KIT 4 CALES	KIT VON 4 STÄRKEN	KIT 4 ESPESORES
4 374914J1	1 NR	SUPPORTO BRACCI	SUPPORT MAIN BOOM	SUPPORT BRAS	HALTERUNG	SOPORTE BRAZOS
5 069590H3	1 NR	PROTEZIONE	PROTECTION	PROTECTION	SCHUTZ	PROTECCIÓN
6 076086D2	1 NR	INDICATORE DI ALLINEAMENTO MOBILE	MOVABLE ALIGNMENT INDICATOR	AFFICHAGE DE L'ALIGNEMENT DE LA TELEPHONIE MOBILE	ALIGNMENT INDIKATOR MOBILE	ALINEACIÓN DE INDICADOR DE MÓVIL
7 076101Y1	1 NR	FERMO	RETAINER	ARRÊT	HALTEVORRICHT UNG	BLOQUE
8 264593H2	1 NR	RALLA	FIFTH WHEEL	COURONNE DENTÉE	DREHKRANZ	TEJUELO
9 06680400	1 NR	SENSORE	SENSOR	CAPTEUR	SENSOR	SENSOR
10 367460Y1	1 NR	PROTEZIONE	PROTECTION	PROTECTION	SCHUTZ	PROTECCIÓN
11 26741500	2 NR	GIUNTO	COUPLING	JOINT	VERBINDUNG	ACOPLAMIENTO





 SUPPORTO BRACCI
ARMEHALTERUNG 
 ARMS SUPPORT
SOPORTE BRAZOS 
 SUPPORT BRAS

POS Codice	Q.tà	 Descrizione	 Description	 Designation	 Benennung	 Descripción
12 076089Y2	1 NR	TUBO	PIPE	TUYAU	ROHR	TUBO
13 067464Y1	1 NR	RISCONTRO	FASTENER LOCATOR	PLAQUE POUR AGRAFAGE	ANSCHLAG	GANCHO
14 064422Y1	1 NR	FERMO	RETAINER	ARRÊT	HALTEVORRICHTUNG	BLOQUE
15 064423Y1	1 NR	PERNO	PIN	GOUJON	ZAPFEN	PERNIO
16 076017H2	4 NR	PROTEZIONE TUBI	PROTECTION	PROTECTION	SCHUTZ	PROTECCION
17 06520700	4 NR	MANIGLIA	HANDLE	POIGNÉE	GRIFF	MANIJA
18 174928H2	4 NR	SNODO	ARTICULATION	ARTICULATION	GELENK	ARTICULACIÓN
19 07611300	4 NR	COPERCHIO	COVER	COUVERCLE	DECKEL	TAPA
20 07599800	4 NR	MOLLA	SPRING	RESSORT	FEDER	MUELLE
21 07585900	4 NR	SPINA	PIN	CHEVILLE	STIFT	CLAVIJA
22 07599600	1 NR	BOCCOLA 25X30 L30 HSG	BUSH 25X30 L30 HSG	DOUILLE 25X30 L30 HSG	BUCHSE 25X30 L30 HSG	CASQUILLO 25X30 L30 HSG
23 07585600	4 NR	SPINA	PIN	CHEVILLE	STIFT	CLAVIJA
24 07583000	4 NR	SPINA	PIN	CHEVILLE	STIFT	CLAVIJA
25 05446300	4 NR	DISCO	DISK	DISQUE	SCHEIBE	DISCO
26 07585800	4 NR	SPINA	PIN	CHEVILLE	STIFT	CLAVIJA

 SUPPORTO BRACCI

 ARMEHALTERUNG 
 ARMS SUPPORT

 SOPORTE BRAZOS 
 SUPPORT BRAS

POS Codice	Q.tà	 Descrizione	 Description	 Designation	 Benennung	 Descripción
27 174929J2	4 NR	STABILIZZATORE COMPLETO	COMPLETE STABILIZER	STABILISATEUR COMPLET	STABILIZER KOMPLETT	ESTABILIZADOR COMPLETO
28 07582800	4 NR	SPINA	PIN	CHEVILLE	STIFT	CLAVIJA
31 06422200	2 NR	BOCCOLA	BUSH	DOUILLE	BUCHSE	CASQUILLO
32 376018H2	4 NR	SUPPORTO SPIA STABILIZZATORE (FOR LL2010-X20JP-X6 00AJ MK2 FROM C170000893)	OUTRIGGER LIGHT SUPPORT (FOR LL2010-X20JP-X6 00AJ MK2 FROM C170000893)	SUPPORT LUMIÈRE STABILISATEUR (FOR LL2010-X20JP-X6 00AJ MK2 FROM C170000893)	LICHTHALTERUN G (FOR LL2010-X20JP-X6 00AJ MK2 FROM C170000893)	SOPORTE LUZ (FOR LL2010-X20JP-X6 00AJ MK2 FROM C170000893)
33 075882H2	2 NR	CARTER DI PROTEZIONE	PROTECTION COVER	PROTECTION	SCHUTZ	PROTECCIÓN
33 077401H2	2 NR	CARTER DI PROTEZIONE	PROTECTION COVER	CARTER DE PROTECTION	CARTER VON SCHUTZ	CARTER DE PROTECCIÓN
34 075883H2	4 NR	CARTER DI PROTEZIONE	PROTECTION COVER	PROTECTION	SCHUTZ	PROTECCIÓN
35 07894700	3 NR	GOMMA ADESIVA DI PROTEZIONE L=250	RUBBER ADHESIVE PROTECTION L=250	GOMME ADHESIVE DE PROTECTION L=250	SCHUTZ-KLEBEG UMMI L=250	GOMA ADHESIVA DE PROTECCIÓN L=250
36 073147Y1	8 NR	SEMIFLANGIA	HALF FLANGE	DEMI-BRIDE	HALB FLANSCH	SEMI BRIDA





 SUPPORTO BRACCI

ARMEHALTERUNG 

 ARMS SUPPORT

SOPORTE BRAZOS 

 SUPPORT BRAS

POS Codice	Q.tà	 Descrizione	 Description	 Designation	 Benennung	 Descripción
37 07314000	1 NR	TAMPONE APPOGGIO PRIMO BRACCIO	BUFFER SUPPORT FIRST ARM	TAMPON DE SUPPORT PREMIER BRAS	PUFFER ARMHALTERUNG	TAMPÓN PRIMER BRAZO
38 076078H3	1 NR	SUPPORTO	SUPPORT	SUPPORT	HALTERUNG	SOPORTE
39 261308H2	1 NR	MOTORE DI ROTAZIONE	ROTARY MOTOR	MOTEUR DE ROTATION	ROTATIONSMOTO R	MOTOR DE ROTACIÓN
40 076114H2	4 NR	SUPPORTO	SUPPORT	SUPPORT	HALTERUNG	SOPORTE

 PRIMO BRACCIO

ERSTER AUSLEGERARM 

 FIRST ARM

PRIMO BRAZO 



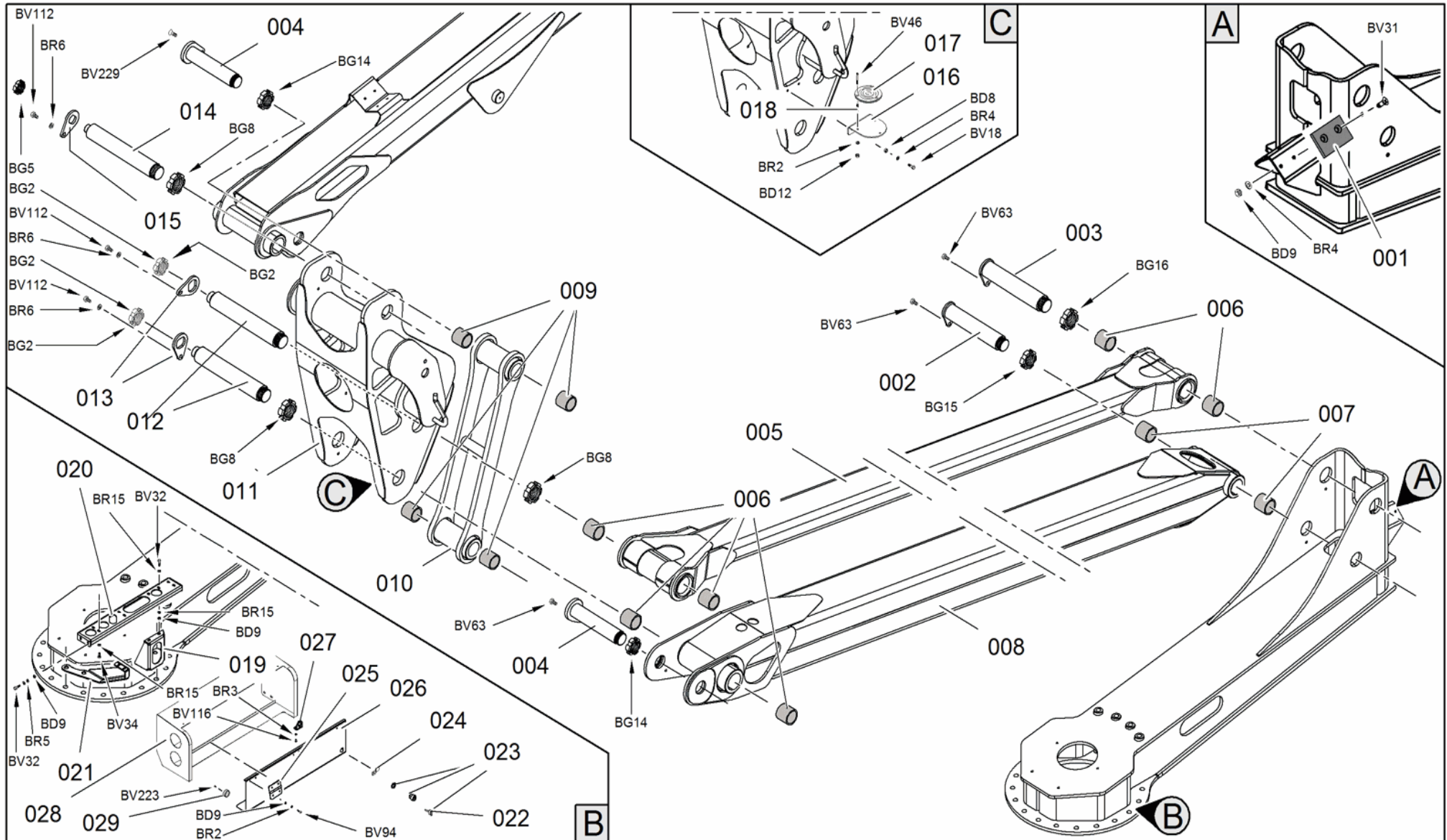

 PREMIER BRAS







 PRIMO BRACCIO

 ERSTER AUSLEGERARM 
 FIRST ARM

 PRIMO BRAZO 
 PREMIER BRAS

POS Codice	Q.tà	 Descrizione	 Description	 Designation	 Benennung	 Descripción
1 05849000	2 NR	PATTINO	SLIDE BLOCK	PATIN	GLEITBLOCK	PATÍN
2 07562700	1 NR	SPINA	PIN	CHEVILLE	STIFT	CLAVIJA
3 07562800	1 NR	SPINA	PIN	CHEVILLE	STIFT	CLAVIJA
4 07563300	1 NR	SPINA	PIN	CHEVILLE	STIFT	CLAVIJA
5 174916J1	1 NR	TIRANTE	TIE ROD	TIRANT	ZUGSTANGE	TIRANTE
6 07563900	4 NR	BOCCOLA 60X65 L40 HSG	BUSH 60X65 L40 HSG	BAGUE	BUCHSE	CASQUILLO
6 07563900	2 NR	BOCCOLA 60X65 L40 HSG	BUSH 60X65 L40 HSG	BAGUE	BUCHSE	CASQUILLO
7 07262200	2 NR	BOCCOLA	BUSH	DOUILLE	BUCHSE	CASQUILLO
8 174915J1	1 NR	PRIMO BRACCIO	FIRST ARM	PREMIER BRAS	ERSTER AUSLEGERARM	PRIMO BRAZO
9 07563800	4 NR	BOCCOLA 50X55 L=40 HSG	BUSH 50X55 L=40 HSG	BAGUE	BUCHSE	CASQUILLO
10 174917J1	1 NR	BIELLA PRIMO-SECONDO BRACCIO COMPLETA	TIEROD FIRST-SECOND BOOMS	BIELLE PREMIER DEUXIÈME BRAS COMPLET	PLEUELSTANGE ERSTER ZWEITER ARM	BARRA DE PRIMER SEGUNDO BRAZO
11 374918J1	1 NR	RINVIO 1°-2° BRACCIO	CONNECTION ROD 1ST-2ND BOOM	RENVOI 1ER -2ÈME BRAS	VORGELEGE 1. -2. ARM	REENVIO 1 ° -2 ° BRAZO





 PRIMO BRACCIO
ERSTER AUSLEGERARM 
 FIRST ARM
PRIMO BRAZO 
 PREMIER BRAS

POS Codice	Q.tà	 Descrizione	 Description	 Designation	 Benennung	 Descripcìon
12 07563100	1 NR	SPINA	PIN	CHEVILLE	STIFT	CLAVIJA
13 07563200	2 NR	GOCCIA SPINA	PIN DROP	BAISSE CHEVILLE	TROPFEN STIFT	CAÍDA CLAVIJA
14 07563700	1 NR	SPINA	PIN	CHEVILLE	STIFT	CLAVIJA
16 058832H3	1 NR	SUPPORTO	SUPPORT	SUPPORT	HALTERUNG	SOPORTE
17 05427200	1 NR	LIVELLA	LEVEL	NIVEAU	WASSERWAAGE	NIVEL DE BURBUJA
18 05444800	3 NR	MOLLA	SPRING	RESSORT	FEDER	MUELLE
19 075885H2	1 NR	STAFFA ANTERIORE SUPPORTO DISTRIBUTORE	FRONT BRACKET MOUNT DISTRIBUTOR	ÉTRIER	HALTEBÜGEL	ESTRIBO
20 075884H2	1 NR	SUPPORTO	SUPPORT	SUPPORT	HALTERUNG	SOPORTE
21 075886H2	1 NR	STAFFA POSTERIORE SUPPORTO DISTRIBUTORE	REAR BRACKET MOUNT DISTRIBUTOR	ÉTRIER	HALTEBÜGEL	ESTRIBO
22 07298800	1 NR	CHIAVE PER SERRATURA POSTAZIONE COMANDO A TERRA	KEY TO THE LOCK ON THE GROUND CONTROL POSITION	CLÉ	SCHLÜSSEL	LLAVE
23 07178800	1 NR	SERRATURA	LOCK	SERRURE	SCHLOSS	CERRADURA





 PRIMO BRACCIO

 ERSTER AUSLEGERARM 
 FIRST ARM

 PRIMO BRAZO 
 PREMIER BRAS

POS Codice	Q.tà	 Descrizione	 Description	 Designation	 Benennung	 Descripción
24 07178900	1 NR	CAMMA PER SERRATURA DISASSAMENTO 3.2	CAM LOCK FOR OFFSET 3.2	CAME	NOCKEN	LEVA
26 073144H2	1 NR	COPERCHIO (FOR LL1775-X17JP-X5 00AJ MK2 FROM C170000893)	COVER (FOR LL1775-X17JP-X5 00AJ MK2 FROM C170000893)	COUVERTURE (FOR LL1775-X17JP-X5 00AJ MK2 FROM C170000893)	DECKUNG (FOR LL1775-X17JP-X5 00AJ MK2 FROM C170000893)	COBERTURA (FOR LL1775-X17JP-X5 00AJ MK2 FROM C170000893)
26 075059H2	1 NR	COPERCHIO SENZA CHIAVE VERSIONE ANSI (FOR LL1775-X17JP-X5 00AJ MK2 FROM C170000893)	COVER WITHOUT KEY ANSI VERSION (FOR LL1775-X17JP-X5 00AJ MK2 FROM C170000893)	COUVERTURE SANS CLÉ (FOR LL1775-X17JP-X5 00AJ MK2 FROM C170000893)	DECKUNG OHNE SCHLÜSSEL (FOR LL1775-X17JP-X5 00AJ MK2 FROM C170000893)	COBERTURA SIN LLAVE (FOR LL1775-X17JP-X5 00AJ MK2 FROM C170000893)
27 073138Y1	1 NR	SUPPORTO SERRATURA	LOCK SUPPORT	SUPPORT SERRURE	SCHLOSSHALTE RUNG	SOPORTE CERRADURA
28 373142H2	1 NR	CARTER DISTRIBUTORE BRACCI (FOR LL1775-X17JP-X5 00AJ MK2 FROM C170000893)	PROTECTION BOOM HYDRAULIC DISTRIBUTOR (FOR LL1775-X17JP-X5 00AJ MK2 FROM C170000893)	PROTECTION DISTRIBUTEUR (FOR LL1775-X17JP-X5 00AJ MK2 FROM C170000893)	SCHUTZ VENTILBLOCK (FOR LL1775-X17JP-X5 00AJ MK2 FROM C170000893)	PROTECCION DISTRIBUIDOR (FOR LL1775-X17JP-X5 00AJ MK2 FROM C170000893)

 PRIMO BRACCIOERSTER AUSLEGERARM  FIRST ARMPRIMO BRAZO  PREMIER BRAS

POS Codice	Q.tà	 Descrizione	 Description	 Designation	 Benennung	 Descripcìon
29 06477600	1 NR	MAGNETE Ø20 CON FORO M3	MAGNETO Ø20 WITH M3 HOLE	AIMANT	MAGNET	IMÁN

 SECONDO BRACCIO

SECOND BRAS 

 SECOND ARM

TWEEDE ARM 

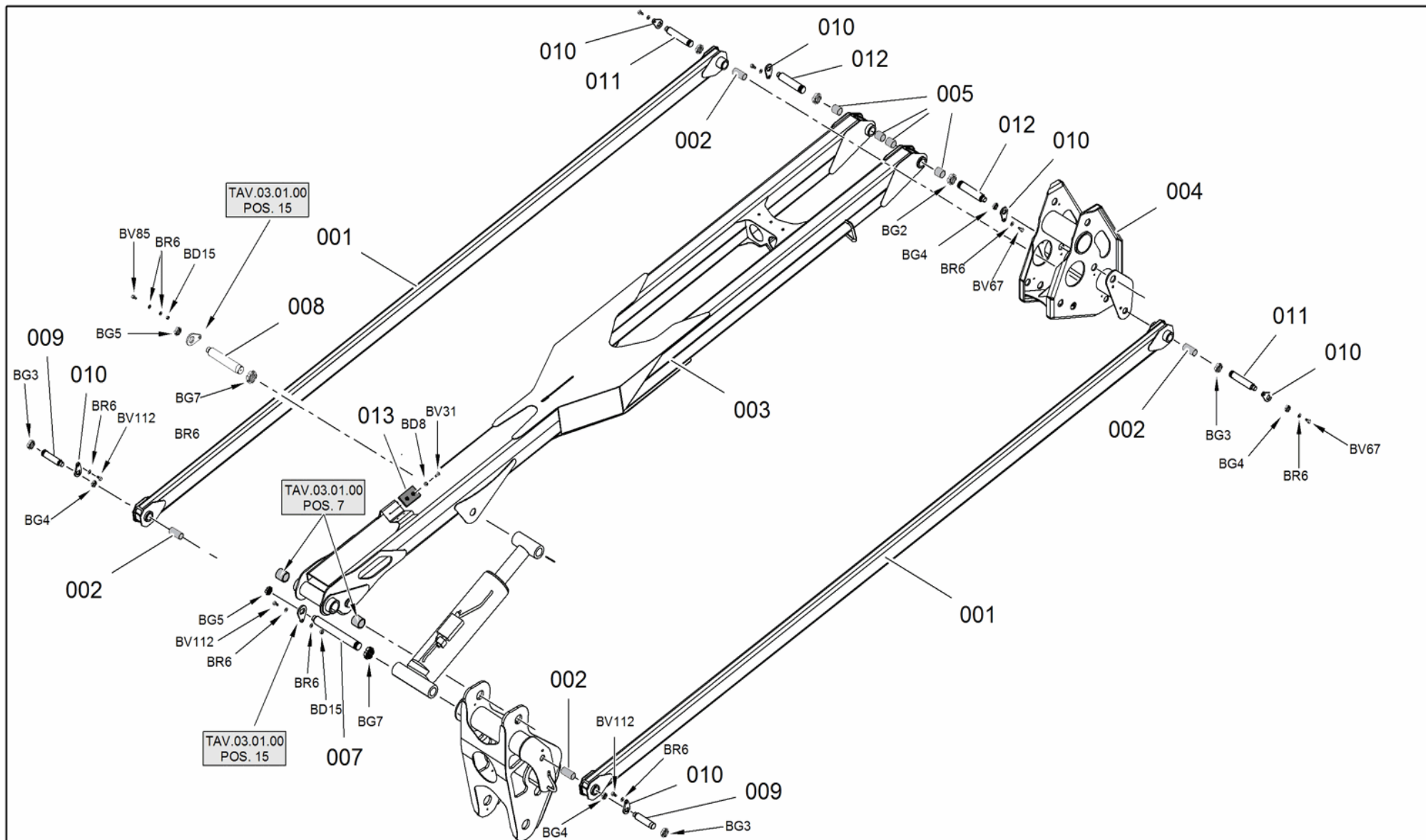

 ZWEITER AUSLEGERARM



 SECONDO BRACCIO

 SECOND BRAS 
 SECOND ARM

 TWEEDE ARM 
 ZWEITER AUSLEGERARM

POS Codice	Q.tà	 Descrizione	 Description	 Designation	 Benennung	 Descripción
1 174921J1	2 NR	TIRANTE SECONDO BRACCIO COMPLETO	TIE ROD SECOND BOOM	TIRANT DEUXIÈME BRAS	ZUGSTANGE ZWEITER ARM	TIRANTE SECUNDO BRAZO
2 06422200	4 NR	BOCCOLA	BUSH	DOUILLE	BUCHSE	CASQUILLO
3 174920J1	1 NR	SECONDO BRACCIO COMPLETO	SECOND BOOM	DEUXIÈME BRAS	ZWEITER ARM	SEGUNDO BRAZO
4 374922J1	1 NR	RINVIO 2°-3° BRACCIO	CONNECTION ROD 2ND-3RD BOOMS	RENOI 2ME-3ME BRAS	VORGELEGE 2.-3. ARM	REENVIO 2 ° -3 ° BRAZO
5 07130500	4 NR	BOCCOLA	BUSH	DOUILLE	BUCHSE	CASQUILLO
7 07563500	1 NR	SPINA	PIN	CHEVILLE	STIFT	CLAVIJA
8 07607900	1 NR	SPINA	PIN	CHEVILLE	STIFT	CLAVIJA
9 07563600	2 NR	SPINA	PIN	CHEVILLE	STIFT	CLAVIJA
11 07539700	2 NR	SPINA	PIN	AXE	STIFT	CLAVIJA
12 07520600	2 NR	SPINA	PIN	AXE	STIFT	CLAVIJA
13 07314500	2 NR	TAMPONE APPOGGIO TERZO BRACCIO	THIRD ARM PAD SUPPORT	TAMPON	PUFFER	TAMPÓN

 TERZO BRACCIO

DRITTER AUSLEGERARM 

 THIRD ARM

TERCER BRAZO 



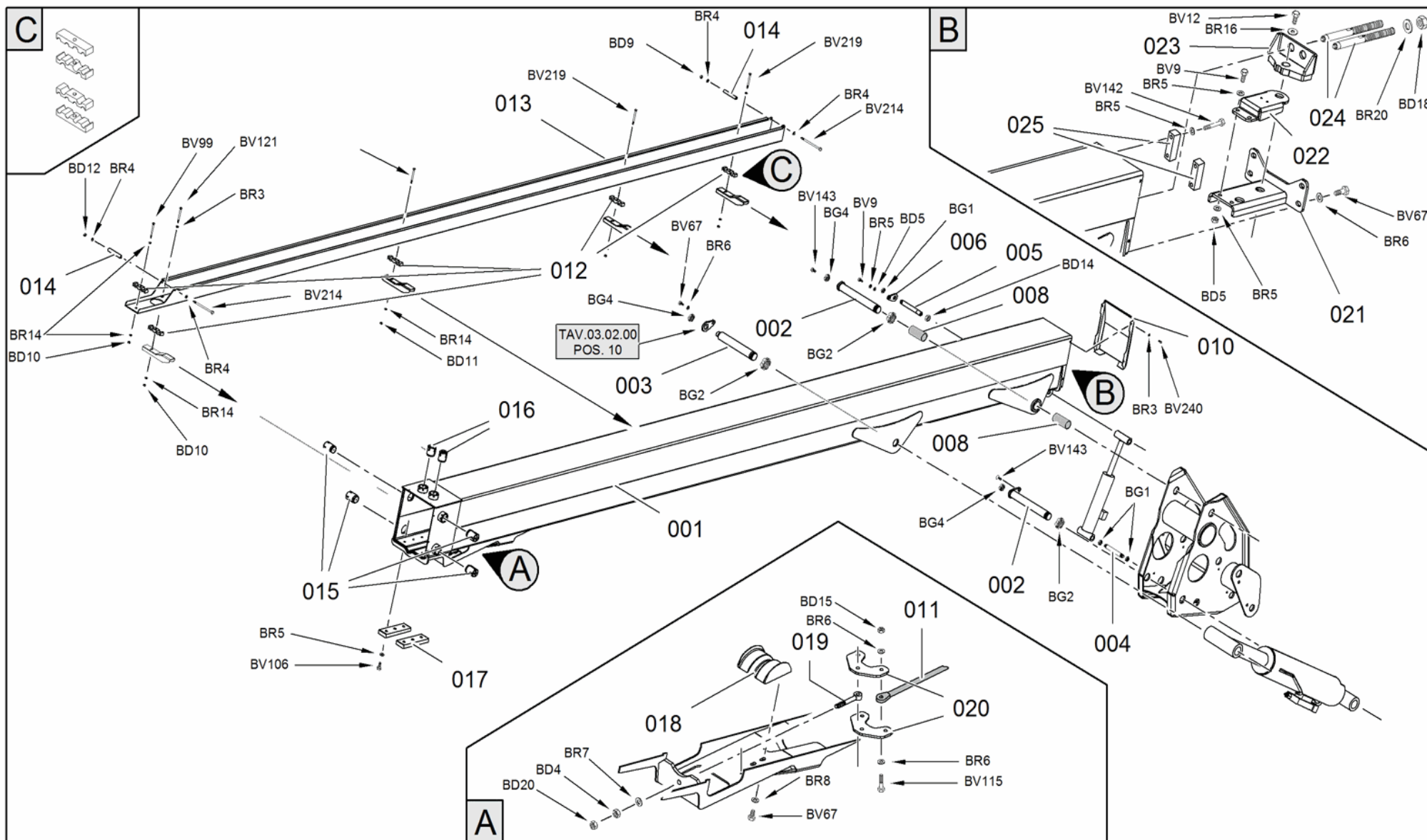

 TROISIÈME BRAS



 TERZO BRACCIO

 DRITTER AUSLEGERARM 
 THIRD ARM





 TERCER BRAZO 
 TROISIÈME BRAS

POS Codice	Q.tà	 Descrizione	 Description	 Designation	 Benennung	 Descripción
1 174923J1	1 NR	TERZO BRACCIO	THIRD ARM	TROISIÈME BRAS	DRITTER AUSLEGERARM	TERCER BRAZO
2 07518400	2 NR	SPINA	PIN	AXE	STIFT	CLAVIJA
3 07539800	1 NR	SPINA	PIN	AXE	STIFT	CLAVIJA
4 06867600	1 NR	SPINA	PIN	CHEVILLE	STIFT	CLAVIJA
5 06230600	1 NR	SPINA	PIN	CHEVILLE	STIFT	CLAVIJA
8 07130500	2 NR	BOCCOLA	BUSH	DOUILLE	BUCHSE	CASQUILLO
10 075308H3	1 NR	CARTER CHIUSURA TERZO BRACCIO	COVER THIRD ARM	COUVERTURE TROISIEME BRAS	DECKUNG 3. ARM	COBERTURA 3° BRAZO
11 07520300	2 NR	FUNE RIENTRO SFILO	ROPE EXTENSION IN	CORDE	SEIL	CUERDA
12 07530500	5 NR	MORSETTO FERMA TUBI	CLAMP	ÉTAU	KLEMME	ABRAZADERA
13 075304H3	1 NR	SUPPORTO CATENARIA	SUPPORT	SUPPORT	HALTERUNG	SOPORTE
14 06518800	2 NR	DISTANZIALE	SPACER	ENTRETOISE	DISTANZSTÜCK	DISTANCIADOR
15 06301200	8 NR	PATTINO	SLIDE BLOCK	PATIN	GLEITBLOCK	PATÍN
16 07246000	4 NR	PATTINO IN PLASTICA	SLIDE BLOCK	PATIN	GLEITBLOCK	PATIN

 TERZO BRACCIO

 DRITTER AUSLEGERARM 
 THIRD ARM

 TERCER BRAZO 
 TROISIÈME BRAS

POS Codice	Q.tà	 Descrizione	 Description	 Designation	 Benennung	 Descripcìon
17 07246700	2 NR	PATTINO IN PLASTICA	SLIDE BLOCK	PATIN	GLEITELEMENT	PATIN
18 07530600	1 NR	SLITTA	SLIDE	COULISSEAU	SCHLITTEN	CORREDERA
19 06458000	1 NR	TIRANTE	TIE ROD	TIRANT	ZUGSTANGE	TIRANTE
20 063063H3	2 NR	PIATTO	PLATE	PLATEAU	PLATTE	PLACA
21 363078Y1	1 NR	SUPPORTO	SUPPORT	SUPPORT	HALTERUNG	SOPORTE
22 063061Y1	1 NR	SUPPORTO	SUPPORT	SUPPORT	HALTERUNG	SOPORTE
23 363074Y1	1 NR	BILANCERE	ROCKER ARM	BALANCIER	KIPPHEBEL	BALANCÍN
24 07520400	2 NR	FUNE SFILO USCITA	ROPE FOR EXTENSION EXIT	CORDE	SEIL	CUERDA
24 17890600	1 NR	KIT RIPRISTINO IMPIANTO FUNI SU 26 METRI	CABLES KIT	KIT CÂBLES	KABELSATZ	KIT CABLES
25 07528700	2 NR	PIATTO	PLATE	PLATEAU	PLATTE	PLACA

 PRIMO SFILÒ

ERSTER TELESKOPARM 



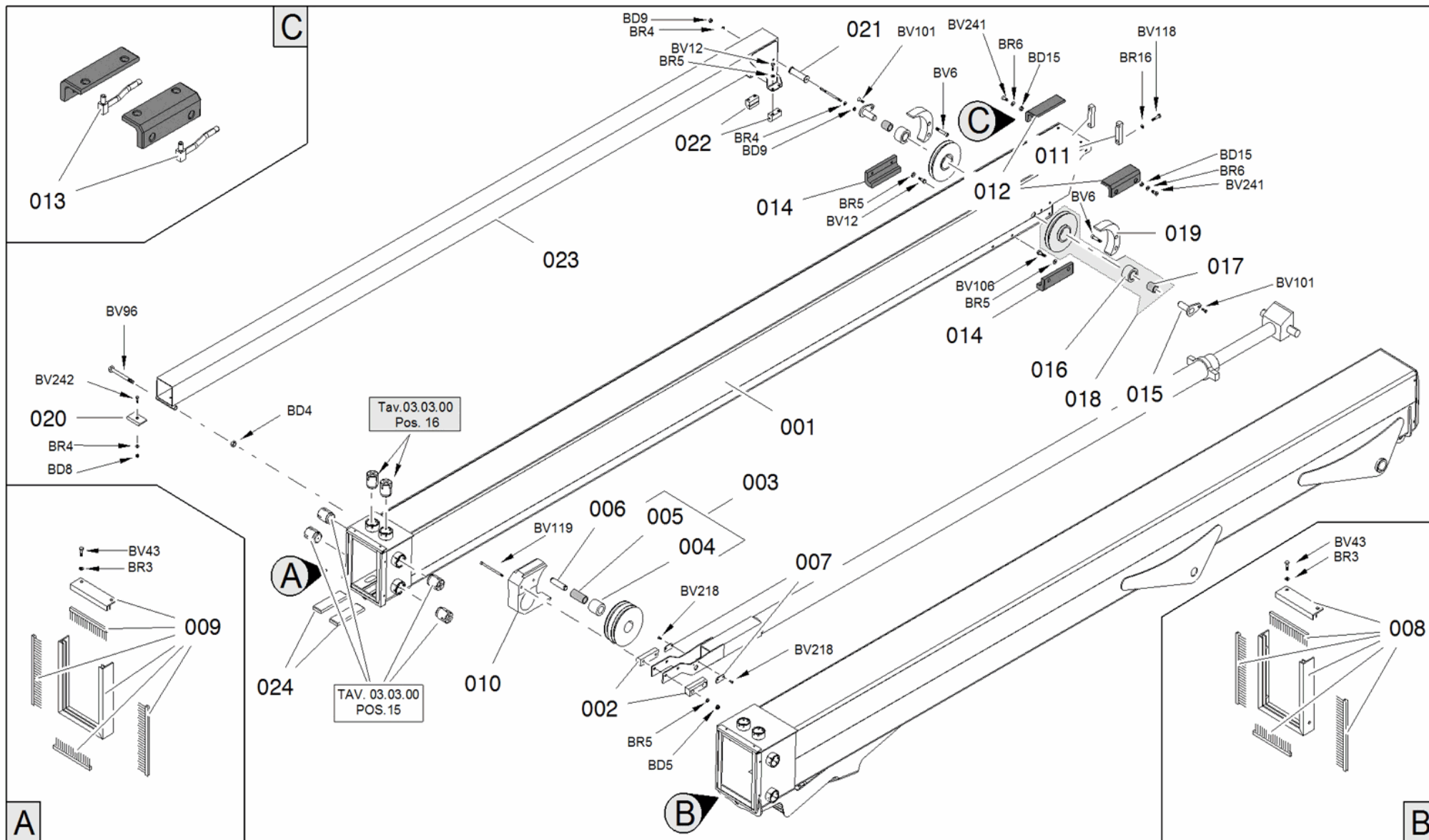

 FIRST EXTENSION ARM

PRIMO BRAZO DE EXTENSION 





 PREMIER BRAS D'EXTRACTION



 PRIMO SFILO
ERSTER TELESKOPARM 
 FIRST EXTENSION ARM
PRIMO BRAZO DE EXTENSION 
 PREMIER BRAS D'EXTRACTION

POS	Codice	Q.tà	 Descrizione	 Description	 Designation	 Benennung	 Descripción
1	374925J2	1 NR	PRIMO SFILO	FIRST BOOM EXTENSION	PREMIÈR BRAS D'EXTRACTION	1. TELESKOPAUSS CHUB	PRIMERA EXTENCIÓN
2	06308800	2 NR	PATTINO	SLIDE BLOCK	PATIN	GLEITBLOCK	PATÍN
3	16510800	1 NR	PULEGGIA	PULLEY	POULIE	SCHEIBE	POLEA
4	06321100	1 NR	BOCCOLA	BUSH	DOUILLE	BUCHSE	CASQUILLO
5	06422400	1 NR	BOCCOLA	BUSH	DOUILLE	BUCHSE	CASQUILLO
6	06309900	1 NR	SPINA	PIN	CHEVILLE	STIFT	CLAVIJA
7	072787Y1	2 NR	PIATTO	PLATE	PLATEAU	PLATTE	PLACA
8	17552300	1 NR	KIT SPAZZOLE	BRUSHES KIT	KIT BROSSES	BÜRSTENSATZ	KIT CEPILLOS
9	17552800	1 NR	KIT SPAZZOLE	BRUSHES KIT	KIT BROSSES	BÜRSTENSATZ	KIT CEPILLOS
10	07552900	1 NR	PATTINO CILINDRO SFILO	SLIDE BLOCK	PATIN	GLEITBLOCK	PATIN
11	063040Y2	2 NR	PIATTO	PLATE	PLATEAU	PLATTE	PLACA
12	07531900	4 NR	PATTINO IN PLASTICA	SLIDE BLOCK	PATIN	GLEITBLOCK	PATIN
13	07607500	2 NR	TUBO RIGIDO	RIGID PIPE	TUYAU RIGIDE	ROHR	TUBO RÍGIDO
14	07533000	2 NR	PATTINO IN PLASTICA	SLIDE BLOCK	PATIN	GLEITELEMENT	PATIN

 PRIMO SFILO
ERSTER TELESKOPARM 
 FIRST EXTENSION ARM
PRIMO BRAZO DE EXTENSION 
 PREMIER BRAS D'EXTRACTION

POS Codice	Q.tà	 Descrizione	 Description	 Designation	 Benennung	 Descripción
15 07552400	2 NR	SPINA	PIN	CHEVILLE	STIFT	CLAVIJA
16 06321200	1 NR	BOCCOLA	BUSH	DOUILLE	BUCHSE	CASQUILLO
17 06422300	1 NR	BOCCOLA	BUSH	DOUILLE	BUCHSE	CASQUILLO
18 16710000	2 NR	PULEGGIA	PULLEY	POULIE	SCHEIBE	POLEA
19 06623000	2 NR	PATTINO	SLIDE BLOCK	PATIN	GLEITBLOCK	PATÍN
20 06586300	1 NR	PATTINO	SLIDE BLOCK	PATIN	GLEITBLOCK	PATÍN
21 06539700	1 NR	RULLO	ROLLER	ROULEAU	ROLLE	RODILLO
22 06624100	2 NR	GUIDA	GUIDE	GLISSIÈRE	FÜHRUNG	GUÍA
23 375332H3	1 NR	SUPPORTO CATENARIA SU PRIMO SFILO	SUPPORT CABLE HOLDER CHAIN ON FIRST EXTENSION BOOM	SUPPORT	HALTERUNG	SOPORTE
24 07246800	2 NR	PATTINO IN PLASTICA	SLIDE BLOCK	PATIN	GLEITELEMENT	PATIN

 SECONDO SFILLO

ZWEITER TELESKOPARM 



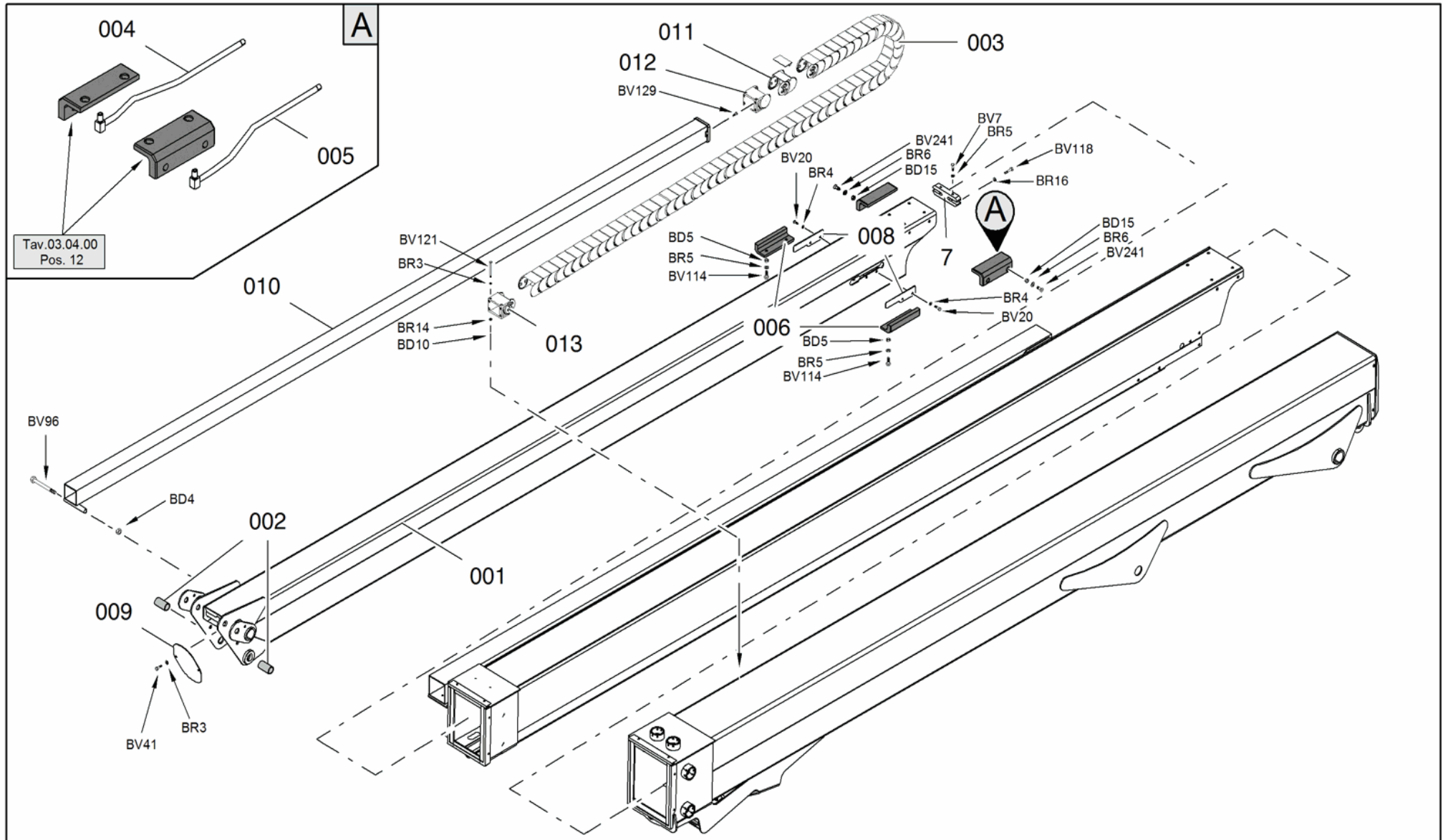

 SECONDO EXTENSION ARM

SEGUNDO BRAZO TELESCÓPICO 





 DEUXIÈME BRAS D'EXTRACTION



 SECONDO SFILO
ZWEITER TELESKOPARM 
 SECONDO EXTENSION ARM
SEGUNDO BRAZO TELESCÓPICO 
 DEUXIÈME BRAS D'EXTRACTION

POS Codice	Q.tà	 Descrizione	 Description	 Designation	 Benennung	 Descripción
1 174926J2	1 NR	SECONDO SFILO	SECOND BOOM EXTENSION	2ME BRAS D'EXTRACTION	2. TELESKOPARM	SEGUNDA EXTENSIÓN
2 06900700	2 NR	BOCCOLA	BUSH	DOUILLE	BUCHSE	CASQUILLO
3 27553000	1 NR	CATENA PORTACAVI	CABLE-HOLDER CHAIN	CHAÎNE PORTE-CÂBLES	KABELHALTERK ETTE	CADENA PORTACABLES
4 07607600	1 NR	TUBO RIGIDO	RIGID PIPE	TUYAU RIGIDE	ROHR	TUBO RÍGIDO
5 07610200	1 NR	TUBO RIGIDO	RIGID PIPE	TUYAU RIGIDE	ROHR	TUBO RÍGIDO
6 07532000	2 NR	PATTINO IN PLASTICA	SLIDE BLOCK	PATIN	GLEITELEMENT	PATIN
7 062962Y2	1 NR	PIASTRA	PLATE	PLATINE	PLATTE	PLACA
8 062967Y1	2 NR	COPERCHIO	COVER	COUVERCLE	DECKEL	TAPA
9 072842H3	1 NR	COPERCHIO	COVER	COUVERTURE	DECKUNG	COBERTURA
10 375318H3	1 NR	SUPPORTO CATENARIA SU SECONDO SFILO	SUPPORT CABLE HOLDER CHAIN ON SECOND EXTENSION BOOM	SUPPORT	HALTERUNG	SOPORTE
11 2755300001	1 NR	MAGLIA COMPLETA PER CATENA PORTACAVI LL2614	CHAIN LINK	MAILLOT	KETTENGLIED	ESLABON

 SECONDO SFILO
ZWEITER TELESKOPARM 
 SECONDO EXTENSION ARM
SEGUNDO BRAZO TELESCÓPICO 
 DEUXIÈME BRAS D'EXTRACTION

POS Codice	Q.tà	 Descrizione	 Description	 Designation	 Benennung	 Descripción
12 2755300002	1 NR	RACCORDO PUNTO FISSO COMPLETA PER CATENA PORTACAVI LL2614	CONNECTION	RACCORD	ANSCHLUSSSTÜ CK	CONEXIÓN
13 2755300003	1 NR	RACCORDO PUNTO MOBILE COMPLETO PER CATENA PORTACAVI LL2614	CONNECTION	RACCORD	ANSCHLUSSSTÜ CK	CONEXIÓN

 SUPPORTO CESTO

 ARMS SUPPORT



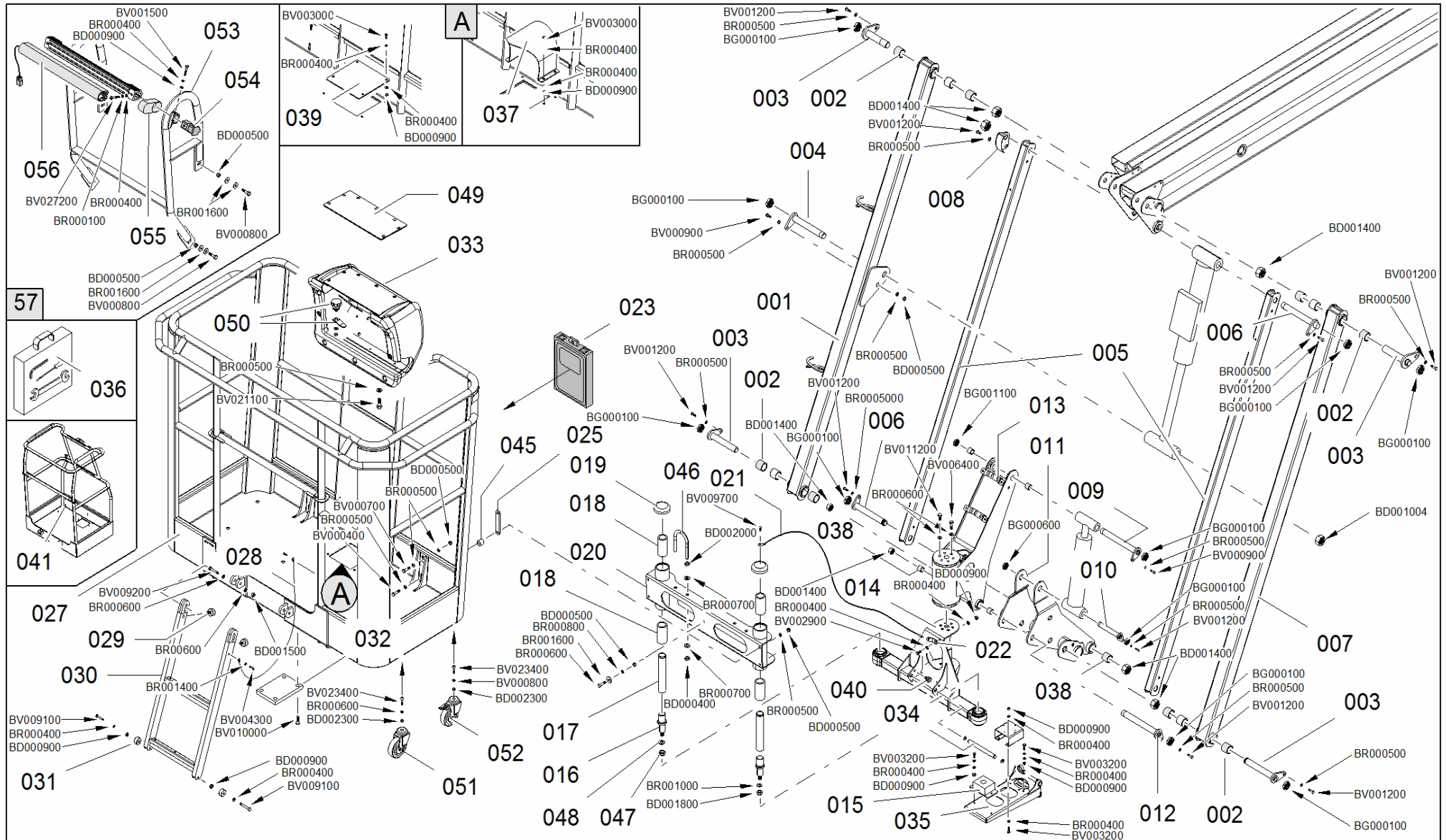

 SUPPORT BRAS

ARMEHALTERUNG 

SUPORTE BRAZOS 







 SUPPORTO CESTO
ARMEHALTERUNG 
 ARMS SUPPORT
SUPORTE BRAZOS 
 SUPPORT BRAS

POS Codice	Q.tà	 Descrizione	 Description	 Designation	 Benennung	 Descripción
1 170948J2	1 NR	BRACCIO JIB COMPLETO DX	COMPLETE JIB ARM RIGHT	BRAS JIB DROITE COMPLÈTE	KORBARM RECHTS	BRAZO JIB DERECHA COMPLETO
2 06272600	4 NR	BOCCOLA	BUSH	DOUILLE	BUCHSE	CASQUILLO
3 07093500	4 NR	SPINA	PIN	CHEVILLE	STIFT	CLAVIJA
4 07093800	1 NR	SPINA	PIN	CHEVILLE	STIFT	CLAVIJA
5 359447J2	2 NR	TIRANTE JIB	TIE ROD JIB	TIRANT	ZUGSTANGE	TIRANTE
6 07093600	2 NR	SPINA	PIN	CHEVILLE	STIFT	CLAVIJA
7 170947J2	1 NR	BRACCIO JIB COMPLETO SX	COMPLETE JIB ARM LEFT	BRAS JIB GAUCHE	KORBARM LINKS	BRAZO JIB IZQUIERDA
8 372264H3	1 NR	CAMMA MICRO JIB	MICROSWITCH CAM JIB	CAME	NOCKEN	LEVA
9 07093700	1 NR	SPINA	PIN	CHEVILLE	STIFT	CLAVIJA
10 06235600	1 NR	SPINA	PIN	CHEVILLE	STIFT	CLAVIJA
11 175401J2	1 NR	RINVIO JIB	JIB CONNECTION ROD	RENVOI	VORGELEGE	REENVIO
12 06235700	1 NR	SPINA	PIN	CHEVILLE	STIFT	CLAVIJA





 SUPPORTO CESTO

 ARMEHALTERUNG 
 ARMS SUPPORT





 SUPORTE BRAZOS 
 SUPPORT BRAS

POS Codice	Q.tà	 Descrizione	 Description	 Designation	 Benennung	 Descripción
13 2648910002	1 NR	KIT GUARNIZIONI	SEAL KIT	KIT DE JOINTS	DICHTUNGSSATZ	KIT DE JUNTAS
13 271778H2	1 NR	MOTORE DI ROTAZIONE RAL7016	ROTARY MOTOR RAL7016	MOTEUR DE ROTATION RAL7016	DREHANTRIEB RAL7016	MOTOR ROTACIÓN RAL7016
14 377660H2	1 NR	SUPPORTO CESTO	BASKET SUPPORT	SUPPORT PANIER	KORBHALTERU NG	SOPORTE CESTA
15 056187H3	1 NR	COPERCHIO	BOX	COUVERCLE	DECKEL	TAPA
16 07190900	2 NR	VITE TE DIN960 CI 8.8 M16X1.5X115 FORATA GEOMET321 PLUS XL	TE SCREW DIN960 CI 8.8 M16X1.5X115 GEOMET321 PERFORATED PLUS XL	VIS TE DIN960 CI 8,8 M16X1.5X115 FORE PLUS GEOMET321 XL	TE SCHRAUBE DIN960 CI 8,8 M16X1.5X115 GEOMET321 PERFORATED PLUS XL	TE TORNILLO DIN960 CI 8,8 M16X1.5X115 GEOMET321 PERFORADA XL
17 07146500	2 NR	PERNO SUPPORTO CESTO DIAM.50	PIN SUPPORT BASKET Ø50	AXE DIAM.50 PANIER DE SOUTIEN	BOLZEN KORBHALTERUN G	CLAVIJA CESTA
18 27146200	4 NR	CUSCINETTO LINEARE A SFERE 50-100	LINEAR BALL BEARING 50-100	ROULEMENT Á BILLES	LINEAR-KUGELLA GER 50-100	COJINETE DE BOLAS 50-100
19 07146400	2 NR	TAPPO CHIUSURA PERNI SUPPORTO CESTO DIAM.50	CAP PINS BASKET SUPPORT Ø50	BOUCHON	VERSCHLUSS	TAPÓN





 SUPPORTO CESTO
ARMEHALTERUNG 
 ARMS SUPPORT
SUPORTE BRAZOS 
 SUPPORT BRAS

POS Codice	Q.tà	 Descrizione	 Description	 Designation	 Benennung	 Descripción
20 371459H2	1 NR	SLITTA FISSAGGIO CESTO PERNI DIAM.50	SLIDE BASKET MOUNTING BOLTS Ø50	COULISSEAU	SCHLITTEN	CORREDERA
21 06665000	2 NR	FUNE	CABLE	CÂBLE	SEIL	CABLE
22 07052900	1 NR	STAFFA	BRACKET	ÉTRIER	HALTEBÜGEL	ESTRIBO
23 05643600	1 NR	CASSETTA PORTAMANUALE	MANUAL BOX	BOÎTE PORTE-MANUEL	BEDIENUNGSANL EITUNGSFACH	CAJA PORTAMANUAL
25 072398H3	2 NR	PIASTRA FISSAGGIO CESTO (SOLO MACCHINE MODELLO JP E JA E X17J)	FIXING PLATE BASKET (ONLY MACHINES MODEL JP AND JA AND X17J)	PLATE FIXATION DRUM	PLATE BEFESTIGUNG DRUM	PLACA FIJACIÓN TAMBOR
27 27589300	1 NR	CESTO BIPOSTO 230KG PER MK2 (DA C170000893)	BASKET 2 PERSON 230KG FOR MK2 (FROM C170000893)	PANIER 2 PERSONNES POUR MK2 (FROM C170000893)	2 MANN-ARBEITSK ORB FÜR MK2 (FROM C170000893)	CESTA 2 PERSONAS PARA MK2 (FROM C170000893)
28 06598500	1 NR	FUNE	CABLE	CÂBLE	SEIL	CABLE
29 05475900	2 NR	ANTIVIBRANTE	ANTI-VIBRATING	ANTI - VIBRANT	VIBRATIONSDÄM PFER	ANTIVIBRANTE
30 36585800	1 NR	SCALETTA	LADDER	ÉCHELLE REPLIABLE	LEITER	ESCALERA PLEGABLE





 SUPPORTO CESTO
ARMEHALTERUNG 
 ARMS SUPPORT
SUPORTE BRAZOS 
 SUPPORT BRAS

POS Codice	Q.tà	 Descrizione	 Description	 Designation	 Benennung	 Descripción
31 06585900	2 NR	ROTELLINA	SMALL ROLLER	ROULETTE	RÄDCHEN	RUEDECILLA
32 058600H3	1 NR	PIASTRA	PLATE	PLAQUE	PLATTE	PLACA
33 17569900	1 NR	PROTEZIONE TELECOMANDO	PROTECTION REMOTE CONTROL	PROTECTION	SCHUTZ	PROTECCIÓN
34 07766500	1 NR	PERNO INCERNIERAMEN TO MENSOLA SUPPORTO CESTO	PIN HINGE BRACKET SUPPORT BASKET	AXE	STIFT	PERNIO
35 377661H2	1 NR	MENSOLA SUPPORTO CELLA DI CARICO	BRACKET SUPPORT LOAD CELL	BRIDE SUPPORT CELLULE DE CHARGE	STEIGBÜGELHAL TERUNG FÜRLASTÜBERW ACHUNGSZELLE	BRIDA SOPORTE CELULA DE CARGA
37 06418600	1 NR	PROTEZIONE	PROTECTION	PROTECTION	SCHUTZ	PROTECCIÓN
38 06272700	2 NR	BOCCOLA	BUSH	DOUILLE	BUCHSE	CASQUILLO
40 07771500	1 NR	MANIGLIA	HANDLE	POIGNÉE	GRIFF	MANIJA
43 072404H3	1 NR	SUPPORTO PEDALE	PEDAL SUPPORT PLATE	TÔLE PLIÉE	HALTERUNG	SOPORTE

 SUPPORTO CESTO
ARMEHALTERUNG 
 ARMS SUPPORT
SUPORTE BRAZOS 
 SUPPORT BRAS

POS Codice	Q.tà	 Descrizione	 Description	 Designation	 Benennung	 Descripción
45 07239700	2 NR	DISTANZIALE PER VITI M8 SUPPORTO CESTO (SOLO MACCHINE MODELLO JP E JA E X17J)	SPACER SCREW M8 SUPPORT BASKET (ONLY MACHINES MODEL JP AND JA AND X17J)	ENTRETOISE	DISTANZSTÜCK	DISTANCIADOR
46 07031800	2 NR	TUBO	PIPE	TUYAU	ROHR	TUBO
47 07193000	2 NR	DADO AD INTAGLI UNI5593 CI 8 M16X1.5 GEOMET321 PLUS XL	NUT M16X1.5 NOTCHES UNI5593 CI 8 GEOMET321 PLUS XL	ÉCROU UNI5593 CI 8 M16X1.5 GEOMET321 PLUS XL	MUTTER UNI5593 CI 8 M16X1.5 GEOMET321 PLUS XL	TUERCA UNI5593 CI 8 M16X1.5 GEOMET321 PLUS XL
48 07192600	2 NR	RONDELLA SPECIALE HV 300 - D 17X48X6 GEOMET321/A+P LUS XL	SPECIAL WASHER HV 300 - 17X48X6 GEOMET321 D / A + PLUS XL	RONDELLE SPECIALE HV 300 - 17X48X6 GEOMET321 D / A + PLUS XL	SCHEIBE HV 300 - 17X48X6 GEOMET321 D / A + PLUS XL	ARANDELA ESPECIAL HV 300 - 17X48X6 GEOMET321 D / A + PLUS XL
49 07690700	1 NR	PROTEZIONE TRASPARENTE	PROTECTION	PROTECTION	SCHUTZ	PROTECCIÓN
50 07192700	1 NR	CHIUSURA A VOLANTINO CON LEVA PIEGATA (SOLO MACCHINE MODELLO JP E JA E X17J)	LOCKING WHEEL WITH BENT LEVER (ONLY MACHINES MODEL JP AND JA AND X17J)	POIGNEE DE BLOCAGE	KUGELVERSCHL USS	POMO DE BLOQUEO

 SUPPORTO CESTO
ARMEHALTERUNG 
 ARMS SUPPORT
SUPORTE BRAZOS 
 SUPPORT BRAS

POS Codice	Q.tà	 Descrizione	 Description	 Designation	 Benennung	 Descripción
51 07687300	2 NR	RUOTE INFERIORI PER CESTO	LOWER WHEEL	ROULEAU INFERIEUR	UNTERES RAD	RUEDA INFERIOR
52 07751100	2 NR	RUOTE INFERIORI PER CESTO CON FRENO	LOWER WHEELS FOR BASKET WITH BRAKE	ROUES POUR PANIER	KORBRÄDER	RUEDAS
53 37609800	1 NR	TELAIO SUPPORTO SKY-GUARD CESTO BIPOSTO	SKY-FRAME SUPPORT GUARD BASKET 2PERSON	CHÂSSIS	RAHMEN	CHASIS
54 07796900	2 NR	BLOCCHETTO PLASTICA PER FISSAGGIO SKYGUARD (1001188889)	BLOCK PLASTIC FOR SECURING SKYGUARD (1001188889)	BLOC	BLOCK	BLOQUE
55 07797000	2 NR	COVER IN GOMMA PER PROTEZIONE FISSAGGIO SKY GUARD (1001186517)	COVER RUBBER PROTECTION FOR FIXING SKY GUARD (1001186517)	PROTECTION	SCHUTZ	PROTECCIÓN
56 27796800	1 NR	SENSORE SKYGUARD	SENSOR SKYGUARD	CAPTEUR	SENSOR	SENSOR
57 17768100	1 NR	KIT SKY GUARD COMPLETO BIPOSTO PER CCBS	SKYGUARD COMPLETE KIT FOR 2 PERSON CCBS	KIT SKY GUARD	SKY GUARD SATZ	KIT SKY GUARD

 ACCOPPIAMENTO MOTORE - POMPA

PUMPEN / MOTOR KUPPLUNG 

 ENGINE COUPLING - PUMP

ACOPLAMIENTO MOTOR - BOMBA 



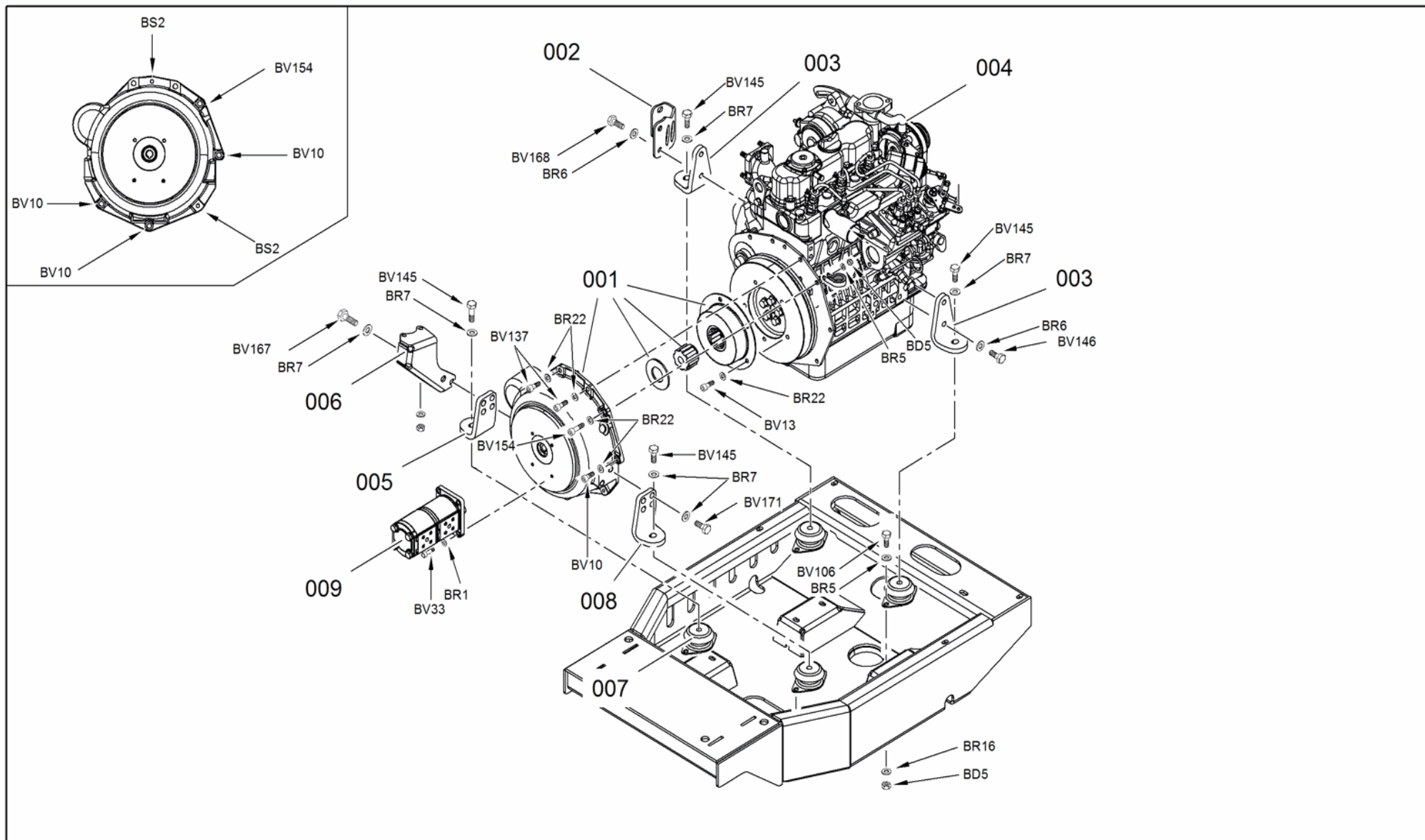

 ACCOUPLEMENT MOTEUR - POMPE



 ACCOPPIAMENTO MOTORE - POMPA

 PUMPEN / MOTOR KUPPLUNG 
 ENGINE COUPLING - PUMP

 ACOPLAMIENTO MOTOR - BOMBA 
 ACCOUPLEMENT MOTEUR - POMPE

POS Codice	Q.tà	 Descrizione	 Description	 Designation	 Benennung	 Descripción
1 27560400	1 NR	ACCOPPIAMENT O MOTORE-POMPA	HYDRAULIC PUMP-MOTOR COUPLING	ACCOUPLEMENT MOTEUR-POMPE	MOTOR-PUMPE KUPPLUNG	ACOPLAMIENTO MOTOR-BOMBA
2 075720Y1	1 NR	STAFFA	BRACKET	ÉTRIER	HALTEBÜGEL	ESTRIBO
3 075718Y1	2 NR	SUPPORTO MOTORE KUBOTA POSTERIORE	SUPPORT	SUPPORT	HALTERUNG	SOPORTE
4 27494100	1 NR	KIT MOTORE KUBOTA CON ACCESSORI	KIT KUBOTA ENGINE WITH ATTACHMENTS	KIT MOTEUR KUBOTA AVEC ACCESSOIRES	KUBOTA MOTOR MIT ZUBEHÖREN	KIT MOTOR KUBOTA CON ACCESORIOS
5 075716Y1	1 NR	SUPPORTO MOTORE KUBOTA SINISTRO	LEFT KUBOTA ENGINE SUPPORT	SUPPORT MOTEUR KUBOTA GAUCHE	HALTERUNG KUBOTA MOTOR	SOPORTE MOTOR KUBOTA IZQUIERDO
6 075719Y1	1 NR	STAFFA FISSAGGIO ANTERIORE MARMITTA	BRACKET	BRIDE	BÜGEL	BRIDA
7 27018000	4 NR	ANTIVIBRANTE	ANTI-VIBRATING	ANTI - VIBRANT	VIBRATIONSDÄM PFER	ANTIVIBRANTE
8 075717Y1	1 NR	SUPPORTO MOTORE KUBOTA DESTRO	RIGHT KUBOTA ENGINE SUPPORT	SUPPORT MOTEUR KUBOTA DROITE	KUBOTA MOTOR HALTERUNG	SOPORTE MOTOR KUBOTA DERECHO





 ACCOPPIAMENTO MOTORE - POMPA

PUMPEN / MOTOR KUPPLUNG 

 ENGINE COUPLING - PUMP

ACOPLAMIENTO MOTOR - BOMBA 

 ACCOUPLEMENT MOTEUR - POMPE

POS Codice	Q.tà	 Descrizione	 Description	 Designation	 Benennung	 Descripcìon
9 146152H3	1 NR	POMPA IDRAULICA	HYDRAULIC PUMP	POMPE HYDRAULIQUE	HYDRAULIKPUMP E	BOMBA HYDRÁULICA
9 275205H3	1 NR	POMPA IDRAULICA	HYDRAULIC PUMP	POMPE HYDRAULIQUE	HYDRAULIKPUMP E	BOMBA HYDRÁULICA

 RICAMBI MOTORE DIESEL

MOTORERSATZTEILE DIESEL 



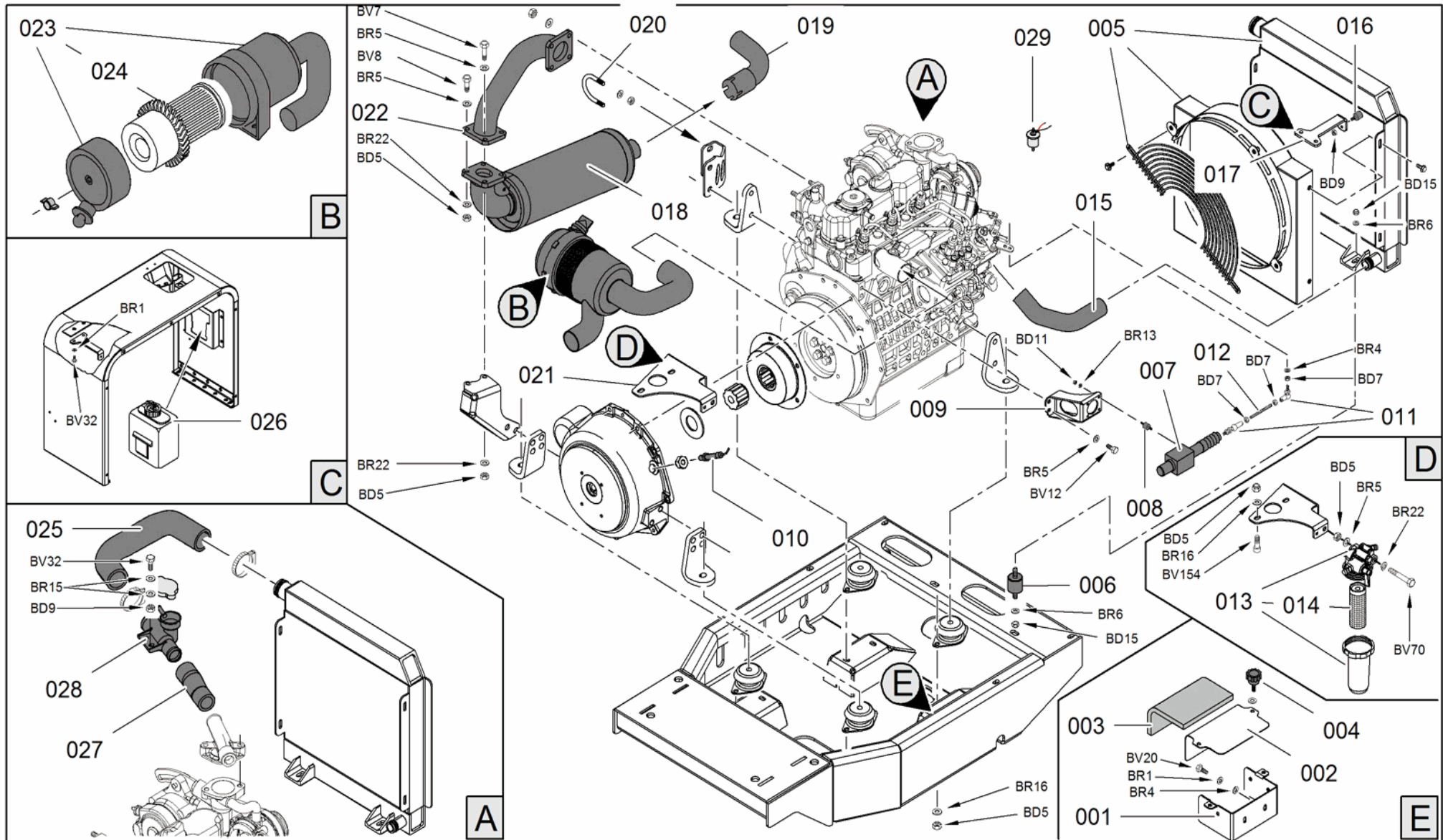

 ENGINE SPARE PARTS DIESEL

REPUESTOS MOTOR DIESEL 





 PIÈCES DÉTACHÉES DU MOTEUR DIESEL



 RICAMBI MOTORE DIESEL
MOTORERSATZTEILE DIESEL 
 ENGINE SPARE PARTS DIESEL
REPUESTOS MOTOR DIESEL 
 PIÈCES DÉTACHÉES DU MOTEUR DIESEL

POS Codice	Q.tà	 Descrizione	 Description	 Designation	 Benennung	 Descripción
1 075991Y1	1 NR	PIEGATO FISSAGGIO COMPONENTI ELETTRICI	SUPPORT	SUPPORT	HALTERUNG	SOPORTE
2 075992Y1	1 NR	COPERCHIO	COVER	COUVERCLE	DECKEL	TAPA
3 07647100	1 NR	RIVESTIMENTO	PROTECTION	PROTECTION	SCHUTZ	PROTECCION
4 05903300	2 NR	POMELLO	KNOB	POIGNÉE	KUGELGRIFF	POMO
5 27554600	1 NR	RADIATORE	RADIATOR	RADIATEUR	KÜHLER	RADIATOR
6 06145700	2 NR	ANTIVIBRANTE	ANTI-VIBRATING	ANTI - VIBRANT	VIBRATIONSDÄM PFER	ANTIVIBRANTE
7 26551500	1 NR	PISTONE	PISTON	PISTON	KOLBEN	PISTÓN
8 06551400	4 NR	ANTIVIBRANTE	ANTI-VIBRATING	ANTI - VIBRANT	VIBRATIONSDÄM PFER	ANTIVIBRANTE
9 075985Y1	1 NR	STAFFA	BRACKET	BRIDE	BÜGEL	BRIDA
10 27602400	1 NR	SENSORE DI GIRI PICK UP L=20,62MM	RPM SENSOR	CAPTEUR	DREHZAHLSENS OR	SENSOR
11 07598700	1 NR	SNODO	ANGLE JOINTS	ARTICULATION	GELENK	ARTICULACIÓN
12 07598600	1 NR	TIRANTE FILETTATO M6	TIE ROD	TIRANT	ZUGSTANGE	TIRANTE





 RICAMBI MOTORE DIESEL
MOTORERSATZTEILE DIESEL 
 ENGINE SPARE PARTS DIESEL
REPUESTOS MOTOR DIESEL 
 PIÈCES DÉTACHÉES DU MOTEUR DIESEL

POS Codice	Q.tà	 Descrizione	 Description	 Designation	 Benennung	 Descripcìon
13 17404200	1 NR	FILTRO GASOLIO PER MOTORE KUBOTA Z602 D902	DIESEL FILTER FOR KUBOTA ENGINE Z602 D902	FILTRE À GASOIL POUR MOTEUR KUBOTA Z602 D902	DIESELFILTER FÜR KUBOTA MOTOR Z602 D902	FILTRO GASOIL PARA MOTOR KUBOTA Z602 D902
14 1740420001	1 NR	CARTUCCIA FILTRO GASOLIO PER MOTORE Z602 D902	DIESEL FILTER CARTRIDGE FOR Z602 ENGINE D902	CARTOUCHE FILTRE À GASOIL POUR MOTEUR Z602 D902	DIESELFILTEREL EMENT FÜR Z602 MOTOR D902	CARTUCHO FILTRO GASOIL PARA MOTOR Z602 D902
15 07598900	1 NR	MANICOTTO	MUFF	MANCHON	MUFFE	MANGUITO
16 05689400	1 NR	ANTIVIBRANTE Ø20 H=15 FILETTO M6X18	ANTIVIBRATION Ø20 H = 15 M6X18	ANTI - VIBRANT	VIBRATIONSDÄM PFER	ANTIVIBRANTE
17 064699Y1	1 NR	STAFFA	BRACKET	ÉTRIER	HALTEBÜGEL	ESTRIBO
18 27598400	1 NR	KIT SILENZIATORE PER MOTORE KUBOTA D902	SILENCER	SILENCIEUX	SCHALLDÄMPFE R	SILENCIADOR
19 07589400	1 NR	TERMINALE MARMITTA	EXHAUST	PARTIE FINALE POT D'ÉCHAPPEMEN T	AUSPUFFENDE	TERMINAL DE ESCAPE
20 07635600	1 NR	FASCETTA	CLAMP	COLLIER	KLEMMSCHRAUB E	ABRAZADERA
21 075778Y1	1 NR	STAFFA	BRACKET	BRIDE	BÜGEL	BRIDA

 RICAMBI MOTORE DIESEL



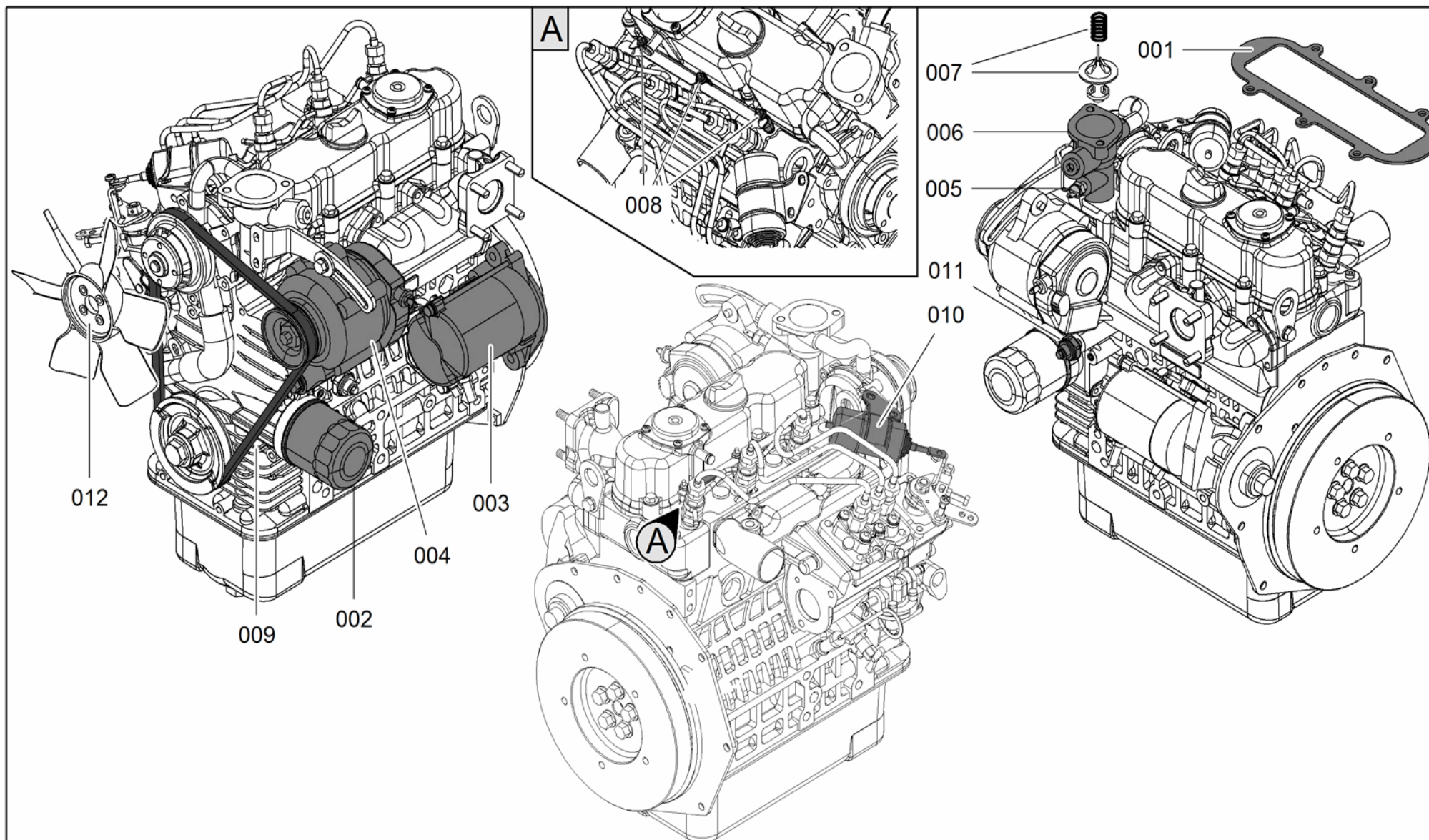

 MOTORERSATZTEILE DIESEL 
 ENGINE SPARE PARTS DIESEL

 REPUESTOS MOTOR DIESEL 
 PIÈCES DÉTACHÉES DU MOTEUR DIESEL

POS Codice	Q.tà	 Descrizione	 Description	 Designation	 Benennung	 Descripcìon
22 07577900	1 NR	COLLETTORE	MANIFOLD	COLLECTEUR	AUSPUFFSAMMLER	COLECTOR
23 2749410002	1 NR	FILTRO ARIA COMPLETO SINGOLA CARTUCCIA PER KUBOTA D902	AIR FILTER	FILTRE A AIR	LUFTFILTER	FILTRO DE AIRE
24 274941000201	1 NR	CARTUCCIA FILTRO ARIA PER KUBOTA D902	AIR FILTER	FILTRE A AIR	LUFTFILTER	FILTRO DE AIRE
25 07541500	1 NR	MANICOTTO DI COLLEGAMENTO	HOSE CONNECTION	MANCHON	MUFFE	MANGUITO
26 25779900	1 NR	VASCHETTA ACQUA	WATER RESERVOIR	BASSINET EAU	WASSERBECKE N	PILA AQUA
27 07541400	1 NR	MANICOTTO COLLEGAMENTO MOTORE-TAPPO	HOSE CONNECTING MOTOR-CAP	MANCHON	MUFFE	MANGUITO
28 27598800	1 NR	TAPPO	CAP	COUVERCLE	DECKEL	TAPA
29 2749410001	1 NR	POMPA GASOLIO AGGIUNTIVA PER MOTORE KUBOTA	PUMP	POMPE	PUMPE	BOMBA

 RICAMBI MOTORE DIESEL ENGINE SPARE PARTS DIESEL PIÈCES DÉTACHÉES DU MOTEUR DIESELMOTORERSATZTEILE DIESEL REPUESTOS MOTOR DIESEL 





 RICAMBI MOTORE DIESEL
MOTORERSATZTEILE DIESEL 
 ENGINE SPARE PARTS DIESEL
REPUESTOS MOTOR DIESEL 
 PIÈCES DÉTACHÉES DU MOTEUR DIESEL

POS Codice	Q.tà	 Descrizione	 Description	 Designation	 Benennung	 Descripción
1 2749410003	1 NR	GUARNIZIONE COPERCHIO PUNTERIE PER MOTORE KUBOTA D902	GASKET	JOINT	DICHTUNG	JUNTA
2 2734250002	1 NR	CARTUCCIA FILTRO OLIO PER MOTORE Z602 D902	CARTRIDGE OLI FILTER FOR DIESEL Z602 D902	CARTOUCHE FILTRE À HUILE POUR MOTEUR Z602 D902	ÖLFILTERPATRO NE FÜR MOTOR Z602 D902	CARTUCHO FILTRO ACEITE PARA MOTOR Z602 D902
3 2749410005	1 NR	MOTORINO AVVIAMENTO	STARTER	DEMARREUR	ANLASSER	MOTOR DE ARRANQUE
4 2734250013	1 NR	ALTERNATORE PER MOTORE Z602 D902	ALTERNATOR FOR MOTOR Z602 D902	ALTERNATEUR POUR MOTEUR Z602 D902	ALTERNATOR FÜR MOTOR Z602 D902	ALTERNADOR PARA MOTOR Z602 D902
5 2734250009	1 NR	BULBO ACQUA PER MOTORE Z602 D902	WATER SENSOR FOR MOTOR Z602 D902	BOULE EAU POUR MOTEUR Z602 D902	WASSER-SENSO R FÜR MOTOR Z602 D902	BOLA AGUA PARA MOTOR Z602 D902
6 2734250010	1 NR	POMPA ACQUA PER MOTORE Z602 D902	WATER PUMP FOR MOTOR Z602 D902	POMPE À EAU POUR MOTEUR Z602 D902	WASSERPUMPE FÜR MOTOR Z602 D902	BOMBA DE AGUA PARA MOTOR Z602 D902
7 2734250008	1 NR	TERMOSTATO PER MOTORE Z602 D902	TEMPERATURE SENSOR FOR MOTOR Z602 D902	THERMOSTAT POUR MOTEUR Z602 D902	THERMOSTAT FÜR MOTOR Z602 D902	TERMÓSTATO PARA MOTOR Z602 D902

 RICAMBI MOTORE DIESEL

 MOTORERSATZTEILE DIESEL 
 ENGINE SPARE PARTS DIESEL

 REPUESTOS MOTOR DIESEL 
 PIÈCES DÉTACHÉES DU MOTEUR DIESEL

POS Codice	Q.tà	 Descrizione	 Description	 Designation	 Benennung	 Descripción
8 2749410004	1 NR	CANDELETTA KUBOTA PER MOTORE D902	GLOW FOR KUBOTA ENGINE D902	PETITE BOUGIE KUBOTA POUR MOTEUR D902	ZÜNDKERZEN KUBOTA FÜR MOTOR D902	BUJÍA KUBOTA PARA MOTOR D902
9 2734250011	1 NR	CINGHIA PER MOTORE Z602 D722 D902	BELT FOR MOTOR Z602 D722 D902	COURROIE POUR MOTEUR Z602 D722 D902	MOTORRIEMEN Z602 D722 D902	CORREA PARA MOTOR Z602 D722 D902
10 2734250004	1 NR	SOLENOIDE STOP PER MOTORE Z602 D902	STOP SOLENOID FOR MOTOR Z602 D902	ARRÊT SOLENOÏDE POUR MOTEUR Z602 D902	MAGNETSCHALT ER FÜR MOTOR Z602 D902	SOLENOIDE STOP PARA MOTOR Z602 D902
11 2734250007	1 NR	BULBO OLIO PER MOTORE Z602 D902	SENSOR ENGINE OIL Z602 D902	BOULE HUILE POUR MOTEUR Z602 D902	ÖLSENSOR FÜR MOTOR Z602 D902	BOLA ACEITE PARA MOTOR Z602 D902
12 2734250001	1 NR	VENTOLA ASPIRANTE PER MOTORE Z602 D902	SUCTION FAN FOR DIESEL Z602 D902	VENTILATEUR D'ASPIRATION Z602 D902	SAUGLÜFTERRA D Z602 D902	VANTILADOR DE ASPIRACIÓN PARA MOTOR Z602 D902

 MOTORI ELETTRICI E POMPA

E-MOTOR 



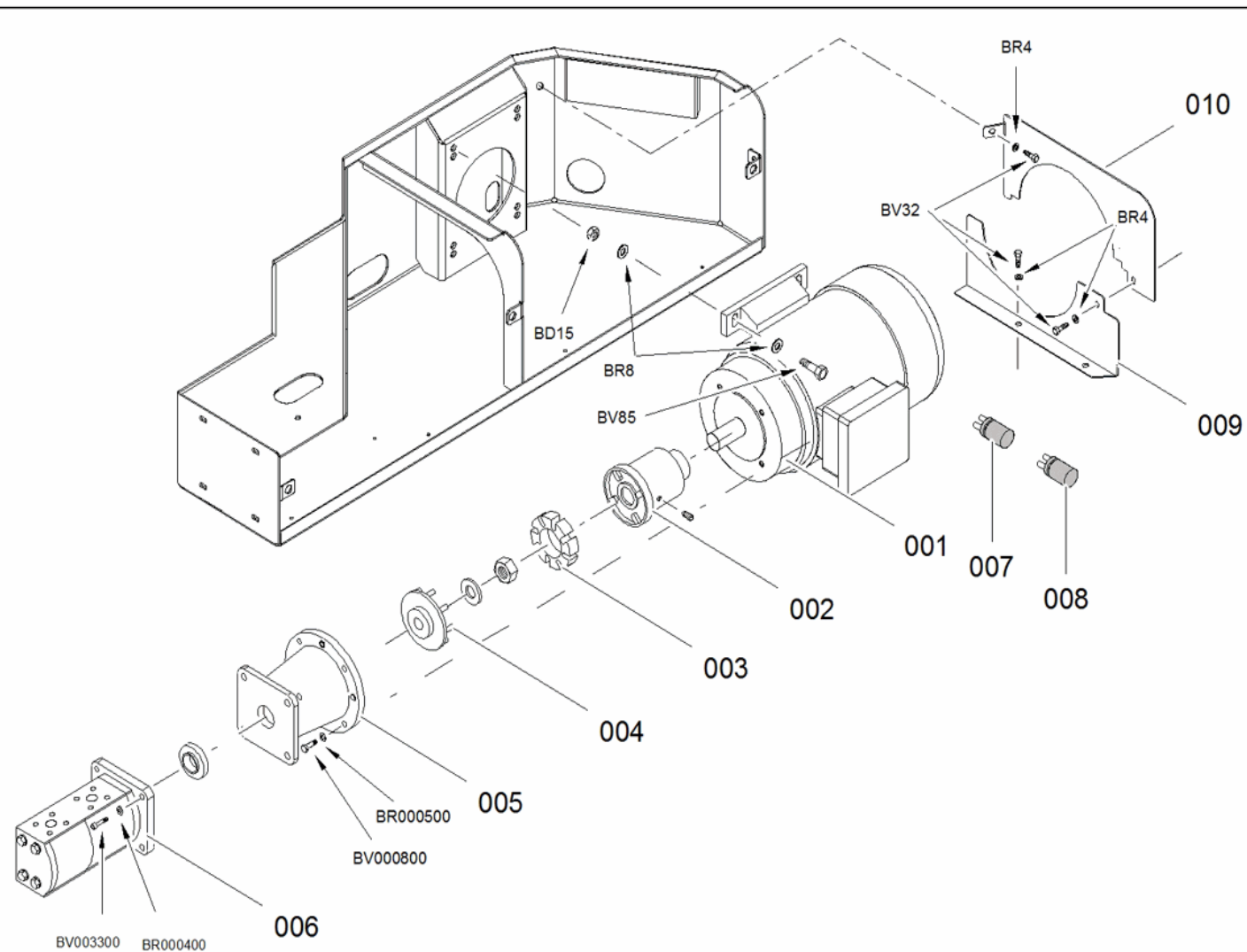

 ELECTRIC MOTOR

MOTOR ELÉCTRICO 





 MOTEUR ÉLECTRIQUE



 MOTORI ELETTRICI E POMPA
E-MOTOR 
 ELECTRIC MOTOR
MOTOR ELÉCTRICO 
 MOTEUR ÉLECTRIQUE

POS Codice	Q.tà	 Descrizione	 Description	 Designation	 Benennung	 Descripcìon
1 26948000	1 NR	MOTORE ELETTRICO 3500W LITHIUM 72V	ELECTRIC MOTOR 3500W LITHIUM 72V	MOTEUR ÉLECTRIQUE 3500W LITHIUM 72V	E-MOTOR 3500W LITHIUM 72V	MOTOR ELÉCTRICO 3500W LITHIUM 72V
1 27691100	1 NR	MOTORE ELETTRICO 230V 50HZ MK2 (DA C170000893)	ELECTRIC MOTOR 230V 50HZ MK2 (FROM C170000893)	MOTEUR ÉLECTRIQUE 230V 50HZ MK2 (FROM C170000893)	E-MOTOR 230V 50HZ MK2 (FROM C170000893)	MOTOR ELÉCTRICO 230V 50HZ MK2 (FROM C170000893)
1 27704300	1 NR	MOTORE ELETTRICO 120V 60HZ 15.8NM MAX	ELECTRIC MOTOR 120V 60HZ 15.8NM MAX	MOTEUR ÉLECTRIQUE 120V 60HZ 15.8NM MAX	E-MOTOR 120V 60HZ 15.8NM MAX	MOTOR ELÉCTRICO 120V 60HZ 15.8NM MAX
2 05563400	1 NR	SEMIGIUNTO VERSIONE MOTORE ELETTRICO STANDARD	HALF COUPLING ELECTRIC MOTOR STANDARD VERSION	DEMI-JOINT	HALBKUPPLUNG	SEMI-ACOPLAMIE NTO
2 06997800	1 NR	SEMIGIUNTO VERSIONE LITIO	HALF COUPLING LITHIUM VERSION	DEMI-JOINT	HALBKUPPLUNG	SEMI-ACOPLAMIE NTO
3 04310100	1 NR	INSERTO IN GOMMA	RUBBER INSERT	INSERT EN CAOUTCHOUC	GUMMIEINSATZ	INSERTO DE GOMA
4 04615300	1 NR	GIUNTO	COUPLING	JOINT	VERBINDUNG	ACOPLAMIENTO
5 05510200	1 NR	LANTERNA	LANTERN	LANTERNE	LATERNE	LINTERNA

 MOTORI ELETTRICI E POMPA
E-MOTOR 
 ELECTRIC MOTOR
MOTOR ELÉCTRICO 
 MOTEUR ÉLECTRIQUE

POS Codice	Q.tà	 Descrizione	 Description	 Designation	 Benennung	 Descripcìon
6 263281H3	1 NR	POMPA IDRAULICA PER MOTORE 120V	HYDRAULIC PUMP FOR ELECTRIC MOTOR 120V	POMPE HYDRAULIQUE	HYDRAULIKPUMP E	BOMBA HYDRÁULICA
6 27763400	1 NR	POMPA IDRAULICA 1.6CC PER MOTORE 120V	HYDRAULIC PUMP 1.6CC FOR ELECTRIC MOTOR 120V	POMPE HYDRAULIQUE 1.6CC	HYDRAULIKPUMP E 1.6CC	BOMBA HYDRÁULICA 1.6CC
7 2551010001	1 NR	CONDENSATORE 230V MF80 D=55	CONDENSER 230V MF80 D=55	CONDENSATEUR	KONDENSATOR	CONDENSADOR
8 2632830002	1 NR	CONDENSATORE PER MOTORE 120V MF160 D=60	CAPACITOR MOTOR 120V MF160 D = 60	CONDENSATEUR	KONDENSATOR	CONDENSADOR
9 076990Y1	1 NR	PIEGATO INFERIORE PER ASPIRAZIONE MOTORE ELETTRICO	PROTECTION	PROTECTION	SCHUTZ	PROTECCION
9 076994Y1	1 NR	PIEGATO INFERIORE PER ASPIRAZIONE MOTORE ELETTRICO VERSIONE LITIO	PROTECTION	PROTECTION	SCHUTZ	PROTECCION





 MOTORI ELETTRICI E POMPA

E-MOTOR 

 ELECTRIC MOTOR

MOTOR ELÉCTRICO 

 MOTEUR ÉLECTRIQUE

POS Codice	Q.tà	 Descrizione	 Description	 Designation	 Benennung	 Descripción
10 076991Y1	1 NR	PIEGATO SUPERIORE PER ASPIRAZIONE MOTORE ELETTRICO	PROTECTION	PROTECTION	SCHUTZ	PROTECCION
10 076995Y1	1 NR	PIEGATO SUPERIORE PER ASPIRAZIONE ELETTRICO VERSIONE LITIO	PROTECTION	PROTECTION	SCHUTZ	PROTECCION

 IMPIANTO IDRAULICO MANDATA E SCARICO

HYDRAULIKANLAGE VORLÄUFE UND RÜCKLAUF 

 SUPPLY AND DISCHARGE HYDRAULIC SYSTEM

INSTALACIÓN HIDRÁULICA IMPULSIONES Y DESCARGA 



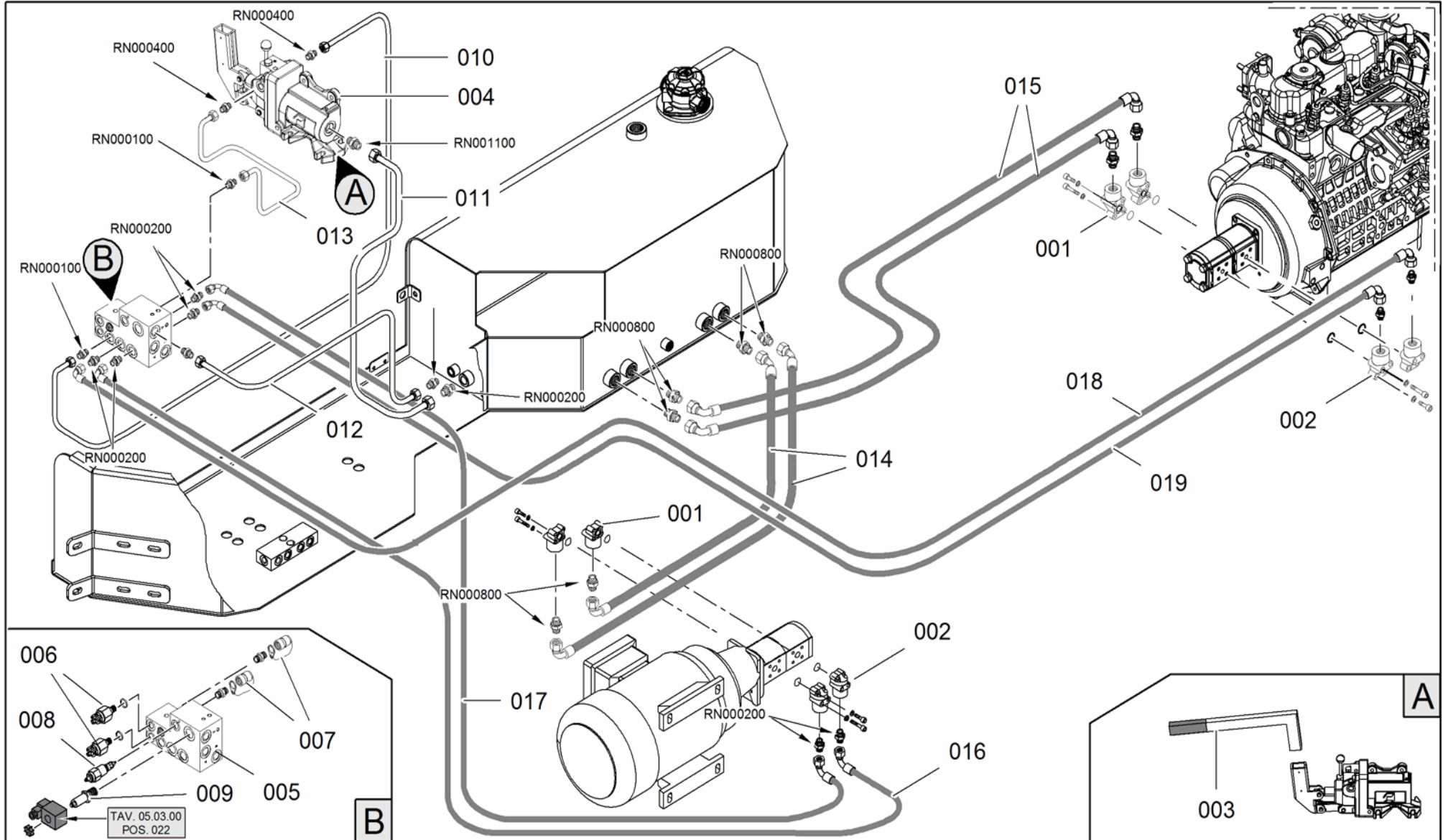

 SYSTÈME HYDRAULIQUE REFOULEMENT ET DÉCHARGEME



 IMPIANTO IDRAULICO MANDATA E SCARICO

 HYDRAULIKANLAGE VORLÄUFE UND RÜCKLAUF 
 SUPPLY AND DISCHARGE HYDRAULIC SYSTEM

 INSTALACIÓN HIDRÁULICA IMPULSIONES Y DESCARGA 
 SYSTÈME HYDRAULIQUE REFOULEMENT ET DÉCHARGEME

POS Codice	Q.tà	 Descrizione	 Description	 Designation	 Benennung	 Descripción
1 04845400	2 NR	FLANGIA 1/2"G	FLANGE 1/2"G	BRIDE 1/2"G	FLANSCH 1/2"G	BRIDA 1/2"G
2 04048100	2 NR	FLANGIA 3/8" G	FLANGE 3/8" G	BRIDE 3/8" G	FLANSCH 3/8" G	BRIDA 3/8" G
3 16517700	1 NR	LEVA	LEVER	LEVIER	HEBEL	PALANCA
4 26459400	1 NR	POMPA A MANO	HAND PUMP	POMPE MANUELLE	HANDPUMPE	BOMBA DE MANO
5 16478200	1 NR	VALVOLA IDRAULICA	HYDRAULIC VALVE	VALVE HYDRAULIQUE	HYDRAULIKVENTIL	VÁLVULA HIDRÁULICA
6 26964400	2 NR	PRESSOSTATO	PRESSURE SWITCH	PRESSOSTAT	DRUCKSCHALTE	PRESÓSTATO
7 03014400	2 NR	PROVA PRESSIONE 1/4" G	PRESSURE TEST 1/4" G	PREUVE PRESSION 1/4" G	DRUCKKONTROLLE 1/4" G	PRUEBA PRESIÓN 1/4" G
8 1647820001	1 NR	VALVOLA IDRAULICA	HYDRAULIC VALVE	VALVE HYDRAULIQUE	HYDRAULIKVENTIL	VÁLVULA HIDRÁULICA
9 1647820003	1 NR	ELETTROVALVOLA	SOLENOID VALVE	ÉLECTROVANNE	MAGNETVENTIL	ELECTROVÁLVULA
10 07580400	1 NR	TUBO RIGIDO	RIGID PIPE	TUYAU RIGIDE	ROHR	TUBO RÍGIDO
11 07580500	1 NR	TUBO RIGIDO	RIGID PIPE	TUYAU RIGIDE	ROHR	TUBO RÍGIDO
12 07580600	1 NR	TUBO RIGIDO	RIGID PIPE	TUYAU RIGIDE	ROHR	TUBO RÍGIDO
13 07580300	1 NR	TUBO RIGIDO	RIGID PIPE	TUYAU RIGIDE	ROHR	TUBO RÍGIDO
14 07628100	2 NR	TUBO FLESSIBILE	FLEXIBLE PIPE	TUYAU FLEXIBLE	SCHLAUCH	TUBO FLEXIBLE





 IMPIANTO IDRAULICO MANDATA E SCARICO

HYDRAULIKANLAGE VORLÄUFE UND RÜCKLAUF 

 SUPPLY AND DISCHARGE HYDRAULIC SYSTEM

INSTALACIÓN HIDRÁULICA IMPULSIONES Y DESCARGA 

 SYSTÈME HYDRAULIQUE REFOULEMENT ET DÉCHARGEME

POS Codice	Q.tà	 Descrizione	 Description	 Designation	 Benennung	 Descripcìon
15 07627900	2 NR	TUBO FLESSIBILE	FLEXIBLE PIPE	TUYAU FLEXIBLE	SCHLAUCH	TUBO FLEXIBLE
16 07628200	1 NR	TUBO FLESSIBILE	FLEXIBLE PIPE	TUYAU FLEXIBLE	SCHLAUCH	TUBO FLEXIBLE
17 07628300	1 NR	TUBO FLESSIBILE	FLEXIBLE PIPE	TUYAU FLEXIBLE	SCHLAUCH	TUBO FLEXIBLE
18 07628500	1 NR	TUBO FLESSIBILE	FLEXIBLE PIPE	TUYAU FLEXIBLE	SCHLAUCH	TUBO FLEXIBLE
19 07628400	1 NR	TUBO FLESSIBILE	FLEXIBLE PIPE	TUYAU FLEXIBLE	SCHLAUCH	TUBO FLEXIBLE

 IMPIANTO IDRAULICO MANDATA E SCARICO

HYDRAULIKANLAGE VORLÄUFE UND RÜCKLAUF 

 SUPPLY AND DISCHARGE HYDRAULIC SYSTEM

INSTALCIÓN HIDRÁULICA IMPULSIONES Y DESCARGA 

 SYSTÈME HYDRAULIQUE REFOULEMENT ET DÉCHARGEME

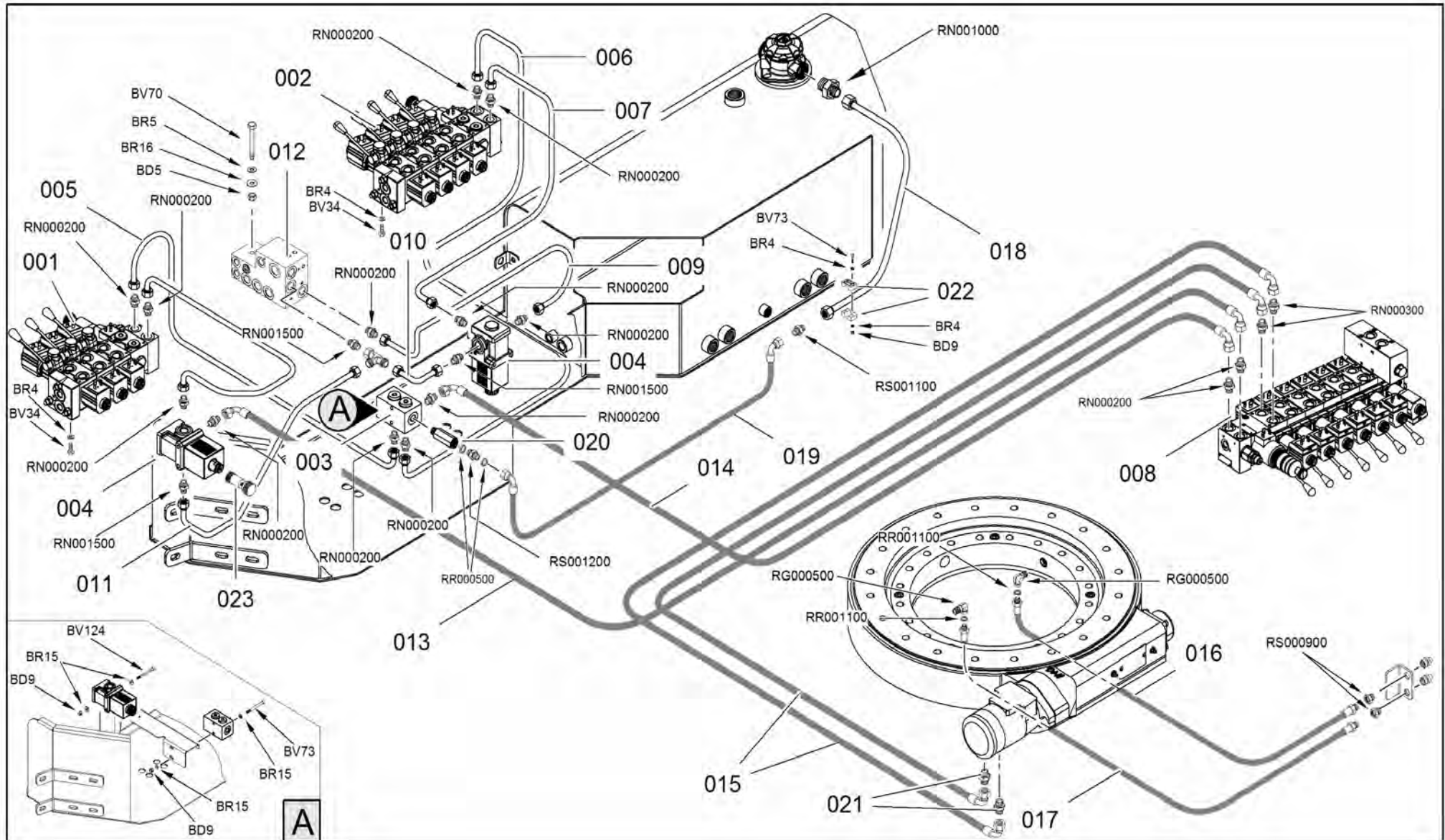





 IMPIANTO IDRAULICO MANDATA E SCARICO

HYDRAULIKANLAGE VORLÄUFE UND RÜCKLAUF 





 SUPPLY AND DISCHARGE HYDRAULIC SYSTEM

INSTALACIÓN HIDRÁULICA IMPULSIONES Y DESCARGA 

 SYSTÈME HYDRAULIQUE REFOULEMENT ET DÉCHARGEME

POS Codice	Q.tà	 Descrizione	 Description	 Designation	 Benennung	 Descripción
1 27299000	1 NR	DISTRIBUTORE LC STABILIZZATORI-T RAINO 3 ELEMENTI CON LEVE EMERGENZA A PULSANTE	HYDRAULIC DISTRIBUTOR STABILIZERS-TRA CKS 3 PARTS WITH LEVERS EMERGENCY BUTTON	DISTRIBUTEUR HYDRAULIQUE	HYDR. REGELSTEUERG ERÄT	DISTRIBUIDOR HIDRÁULICO
2 27299100	1 NR	DISTRIBUTORE LC STABILIZZATORI-T RAINO 4 ELEMENTI CON LEVE EMERGENZA A PULSANTE	HYDRAULIC DISTRIBUTOR STABILIZERS-TRA CKS 4 PARTS WITH LEVERS EMERGENCY BUTTON	DISTRIBUTEUR HYDRAULIQUE	HYDRAULIKVENTI LBLOCK	DISTRIBUIDOR HIDRÁULICO
3 05497500	1 NR	BLOCCHETTO TUBI	HOSES BLOCK	BLOC TUYAUX	ROHRBLOCK	BLOQUE TUBOS
4 25733000	2 NR	DEVIATORE 3 VIE LC VS81 AN (LC)	3-WAY VALVES	DÉVIATEUR	3-WEGEVENTIL	DESVIADOR
5 07580800	1 NR	TUBO RIGIDO	RIGID PIPE	TUYAU RIGIDE	ROHR	TUBO RÍGIDO
6 07580700	1 NR	TUBO RIGIDO	RIGID PIPE	TUYAU RIGIDE	ROHR	TUBO RÍGIDO
7 07580900	1 NR	TUBO RIGIDO	RIGID PIPE	TUYAU RIGIDE	ROHR	TUBO RÍGIDO

 IMPIANTO IDRAULICO MANDATA E SCARICO
HYDRAULIKANLAGE VORLÄUFE UND RÜCKLAUF 
 SUPPLY AND DISCHARGE HYDRAULIC SYSTEM
INSTALACIÓN HIDRÁULICA IMPULSIONES Y DESCARGA 
 SYSTÈME HYDRAULIQUE REFOULEMENT ET DÉCHARGEME

POS Codice	Q.tà	 Descrizione	 Description	 Designation	 Benennung	 Descripción
8 27533400	1 NR	DISTRIBUTORE IDRAULICO 7 ELEMENTI PARTE AEREA CON PULSANTE (FOR LL1775-X17JP-X5 00AJ-LL2010-X20 JP-X600AJ MK2 FROM C170000893)	HYDRAULIC DISTRIBUTOR 7 ELEMENTS AERIAL PART WITH BUTTON (FOR LL1775-X17JP-X5 00AJ-LL2010-X20 JP-X600AJ MK2 FROM C170000893)	DISTRIBUTEUR HYDRAULIQUE (FOR LL1775-X17JP-X5 00AJ-LL2010-X20 JP-X600AJ MK2 FROM C170000893)	HYDRAULISCHER VERTEILER (FOR LL1775-X17JP-X5 00AJ-LL2010-X20 JP-X600AJ MK2 FROM C170000893)	DISTRIBUIDOR HIDRÁULICO (FOR LL1775-X17JP-X5 00AJ-LL2010-X20 JP-X600AJ MK2 FROM C170000893)
9 07581100	1 NR	TUBO RIGIDO	RIGID PIPE	TUYAU RIGIDE	ROHR	TUBO RÍGIDO
10 07581300	1 NR	TUBO RIGIDO	RIGID PIPE	TUYAU RIGIDE	ROHR	TUBO RÍGIDO
11 07581200	1 NR	TUBO RIGIDO	RIGID PIPE	TUYAU RIGIDE	ROHR	TUBO RÍGIDO
12 07581000	1 NR	TUBO RIGIDO	RIGID PIPE	TUYAU RIGIDE	ROHR	TUBO RÍGIDO
13 07629000	1 NR	TUBO FLESSIBILE	FLEXIBLE PIPE	TUYAU FLEXIBLE	SCHLAUCH	TUBO FLEXIBLE
14 07629100	1 NR	TUBO FLESSIBILE	FLEXIBLE PIPE	TUYAU FLEXIBLE	SCHLAUCH	TUBO FLEXIBLE
15 07628900	2 NR	TUBO FLESSIBILE	FLEXIBLE PIPE	TUYAU FLEXIBLE	SCHLAUCH	TUBO FLEXIBLE
16 07629600	1 NR	TUBO FLESSIBILE	FLEXIBLE PIPE	TUYAU FLEXIBLE	SCHLAUCH	TUBO FLEXIBLE
17 07629700	1 NR	TUBO FLESSIBILE	FLEXIBLE PIPE	TUYAU FLEXIBLE	SCHLAUCH	TUBO FLEXIBLE
18 07580200	1 NR	TUBO RIGIDO	RIGID PIPE	TUYAU RIGIDE	ROHR	TUBO RÍGIDO





 IMPIANTO IDRAULICO MANDATA E SCARICO

HYDRAULIKANLAGE VORLÄUFE UND RÜCKLAUF 

 SUPPLY AND DISCHARGE HYDRAULIC SYSTEM

INSTALACIÓN HIDRÁULICA IMPULSIONES Y DESCARGA 

 SYSTÈME HYDRAULIQUE REFOULEMENT ET DÉCHARGEME

POS Codice	Q.tà	 Descrizione	 Description	 Designation	 Benennung	 Descripción
19 07628000	1 NR	TUBO FLESSIBILE	FLEXIBLE PIPE	TUYAU FLEXIBLE	SCHLAUCH	TUBO FLEXIBLE
20 07647200	1 NR	RACCORDO	PIPE FITTING	RACCORD	ANSCHLUSS	CONEXIÓN
21 06936300	2 NR	RACCORDO SPECIALE 1/2" 10L Ø=1,2MM	SPECIAL FITTING 1/2" 10L Ø=1,2MM	RACCORD	ANSCHLUSS	CONEXIÓN
22 04096900	2 NR	MORSETTO	CLAMP	ÉTAU	KLEMME	ABRAZADERA
23 2573300001	1 NR	COMANDO MANUALE DEVIATORE 3 VIE LC VS81 AN (LC)	VALVE	SOUPAPE	VENTIL	VALVULA

 **DISTRIBUTORI IDRAULICI**

HYDRAULISCHE REGELSTEUERGERÄTE 

 **HYDRAULIC DISTRIBUTORS**

DISTRIBUIDORES HIDRÁULICOS 



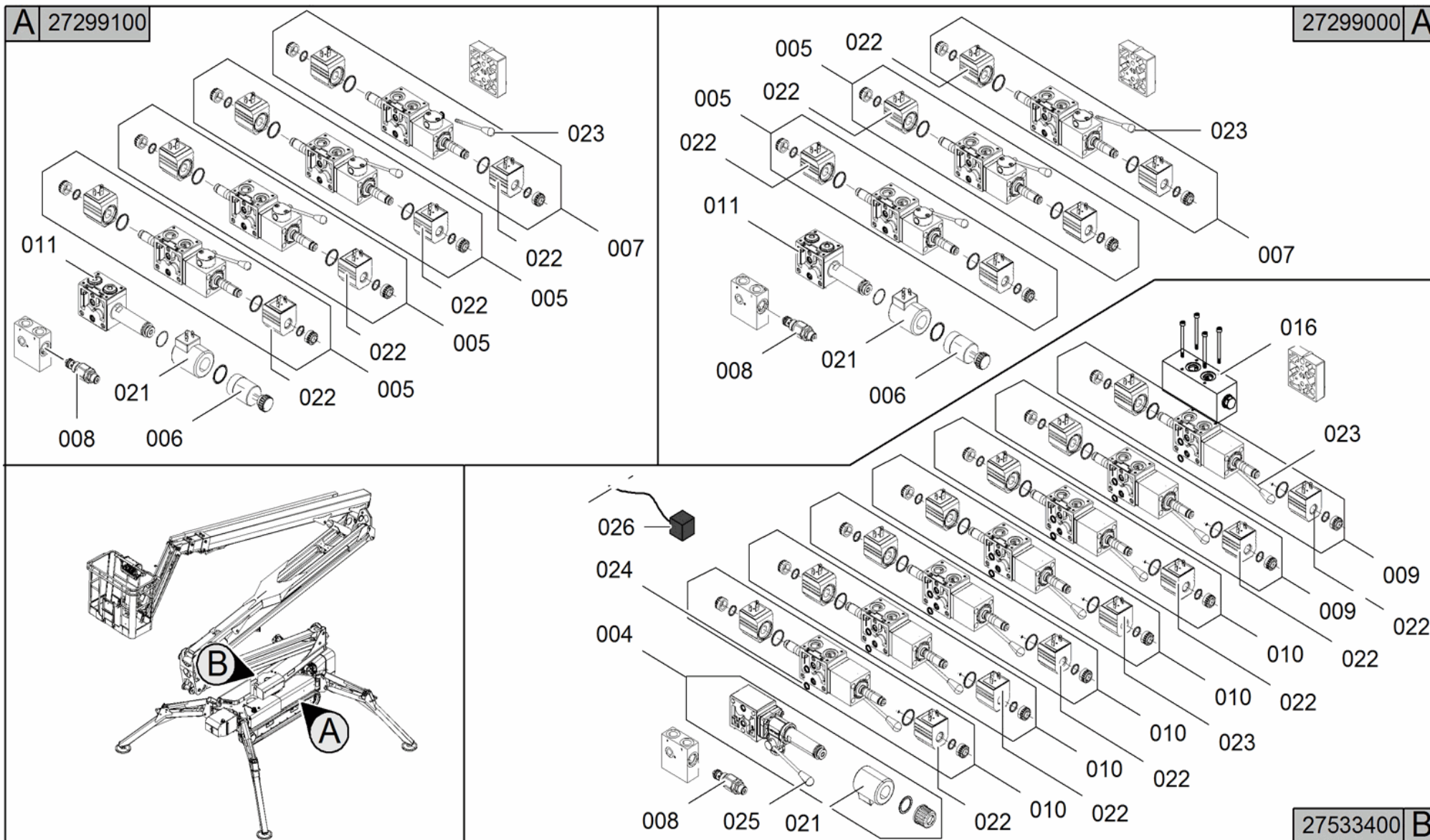

 **DISTRIBUTEURS HYDRAULIQUES**







 DISTRIBUTORI IDRAULICI

 HYDRAULISCHE REGELSTEUERGERÄTE 
 HYDRAULIC DISTRIBUTORS





 DISTRIBUIDORES HIDRÁULICOS 
 DISTRIBUTEURS HYDRAULIQUES

POS Codice	Q.tà	 Descrizione	 Description	 Designation	 Benennung	 Descripción
2 07325200	1 NR	VALVOLA PROPORZIONALE (CARTUCCIA) PARTE AEREA PIATTAFORME CON RITORNO A MOLLA COMPLETA DI PULSANTE	PROPORTIONAL VALVE AERIAL PARTS WITH SPRING RETURN COMPLETE BUTTON	SOUPAPE PROPORTIONELL E	PROPORTIONALV ENTIL	VALVULA PROPORCIONAL
3 06037900	1 NR	BOBINA PER VALVOLA PROPORZIONALE PARTE AEREA	COIL PROPORTIONAL VALVE FOR AERIAL PART	BOBINE	SPULE	BOBINA
4 2753340004	1 NR	ELEMENTO DISTRIBUTORE COMPLETO DI PROPORZIONALE PARTE AEREA CON LEVA ROSSA (LATO 1)	VALVE BLOCK ELEMENT	ELEMENT DISTRIBUTEUR	VENTILBLOCKSA TZ	ELEMENTO DISTRIBUIDOR
5 2645900005	1 NR	SEZIONE DISTRIBUTORE AB CHIUSO CON LEVA (LATO A) E BOBINA	VALVE BLOCK SECTION AB CLOSED WITH LEVER (SIDE A) AND COIL	SECTION DISTRIBUTEUR	VENTILBLOCKSE KTION	SECCIÓN DISTRIBUIDOR

 DISTRIBUTORI IDRAULICI
HYDRAULISCHE REGELSTEUERGERÄTE 
 HYDRAULIC DISTRIBUTORS
DISTRIBUIDORES HIDRÁULICOS 
 DISTRIBUTEURS HYDRAULIQUES

POS Codice	Q.tà	 Descrizione	 Description	 Designation	 Benennung	 Descripción
6 07324900	1 NR	COMANDO MANUALE EMERGENZA CON RITORNO A MOLLA	EMERGENCY MAUAL CONTROL WITH SPRING RETURN	COMMANDE MANUEL D'URGENCE	MANUELLES ANTRIEB FÜR NOTSTAND	MANDO MANUAL DE EMERGENCIA
7 2645900006	1 NR	SEZIONE DISTRIBUTORE ABT CON LEVA (LATO A) E BOBINA	VALVE BLOCK SECTION ABT WITH LEVER (SIDE A) AND COIL	SECTION DISTRIBUTEUR	VENTILBLOCKSE KTION	SECCIÓN DISTRIBUIDOR
8 2645900002	1 NR	CARTUCCIA VALVOLA DI MASSIMA PRESSIONE	CARTRIDGE PRESSURE RELIEF VALVE	CARTOUCHE SOUPAPE DE SÉCURITÉ	PARTONE ÜBERDRUCKVEN TIL	CATUCHO VÁLVULA LIMITADORA DE PRESIÓN
9 2753340002	1 NR	SEZIONE DISTRIBUTORE ABT CON LEVA (LATO 1) E BOBINA	SECTION DISTRIBUTOR ABT WITH LEVER (SIDE 1) AND COIL	SECTION DISTRIBUTEUR	VENTILBLOCKSE KTION	SECCIÓN DISTRIBUIDOR
10 2753340001	1 NR	SEZIONE DISTRIBUTORE AB CHIUSO CON LEVA (LATO 1) E BOBINA	SECTION DISTRIBUTOR AB CLOSED WITH LEVER (SIDE 1) AND COIL	SECTION DISTRIBUTEUR	VENTILBLOCKSE KTION	SECCIÓN DISTRIBUIDOR

 DISTRIBUTORI IDRAULICI
HYDRAULISCHE REGELSTEUERGERÄTE 
 HYDRAULIC DISTRIBUTORS
DISTRIBUIDORES HIDRÁULICOS 
 DISTRIBUTEURS HYDRAULIQUES

POS Codice	Q.tà	 Descrizione	 Description	 Designation	 Benennung	 Descripcìon
11 2729900001	1 NR	VALVOLA PROPORZIONALE TRAINI CON BOBINA E SENZA COMANDO MANUALE A MOLLA	PROPORTIONAL VALVE FOR TRACK WITH COIL AND WITHOUT MANUAL SPRING	SOUPAPE PROPORTIONELL E	PROPORTIONALV ENTIL	VÁLVULA PROPORCIONAL
16 2585560004	1 NR	BLOCCO VALVOLA BILANCIAMENTO BRACCI SU DISTRIBUTORI PARTE AEREA	BALANCING VALVE BLOCK BOOMS OF DISTRIBUTORS AERIAL PART	BLOC SOUPAPE	VENTILSPERRE	BLOQUE VÁLVULA
21 06037100	1 NR	BOBINA PER VALVOLA PROPORZIONALE PARTE CARRO	COIL PROPORTIONAL VALVE FOR UNDERCARRIAG E	BOBINE	SPULE	BOBINA
22 05913800	1 NR	BOBINA PER ON-OFF	COIL FOR ON-OFF	BOBINE	SPULE	BOBINA
23 07300200	1 NR	LEVA DISTRIBUTORE	LEVER HYDRAULIC DISTRIBUTOR	LEVIER	HEBEL	PALANCA
24 2585560005	1 NR	O-RING	O-RING	O-RING	O-RING	O-RING





 DISTRIBUTORI IDRAULICI

HYDRAULISCHE REGELSTEUERGERÄTE 

 HYDRAULIC DISTRIBUTORS

DISTRIBUIDORES HIDRÁULICOS 

 DISTRIBUTEURS HYDRAULIQUES

POS Codice	Q.tà	 Descrizione	 Description	 Designation	 Benennung	 Descripcìon
25 2753340003	1 NR	LEVA ROSSA DISTRIBUTORE	RED LEVER HYDRAULIC DISTRIBUTOR	LEVIER	HEBEL	PALANCA
26 1730720001	1 NR	ELETTROVALVOL A ON-OFF CON LED	SOLENOID ON-OFF WITH LED	ELECTROVANNE ON-OFF AVEC LED	SOLENOID ON-OFF WITH LED	SOLENOIDE ON-OFF CON LED

 IMPIANTO IDRAULICO TRAZIONE

HYDRAULIKANLAGE ANTRIEB 

 HYDRAULIC SYSTEM FOR TRACTION

INSTALACIÓN HIDRÁULICA TRACCIÓN 

 SYSTÈME HYDRAULIQUE DE TRACTION

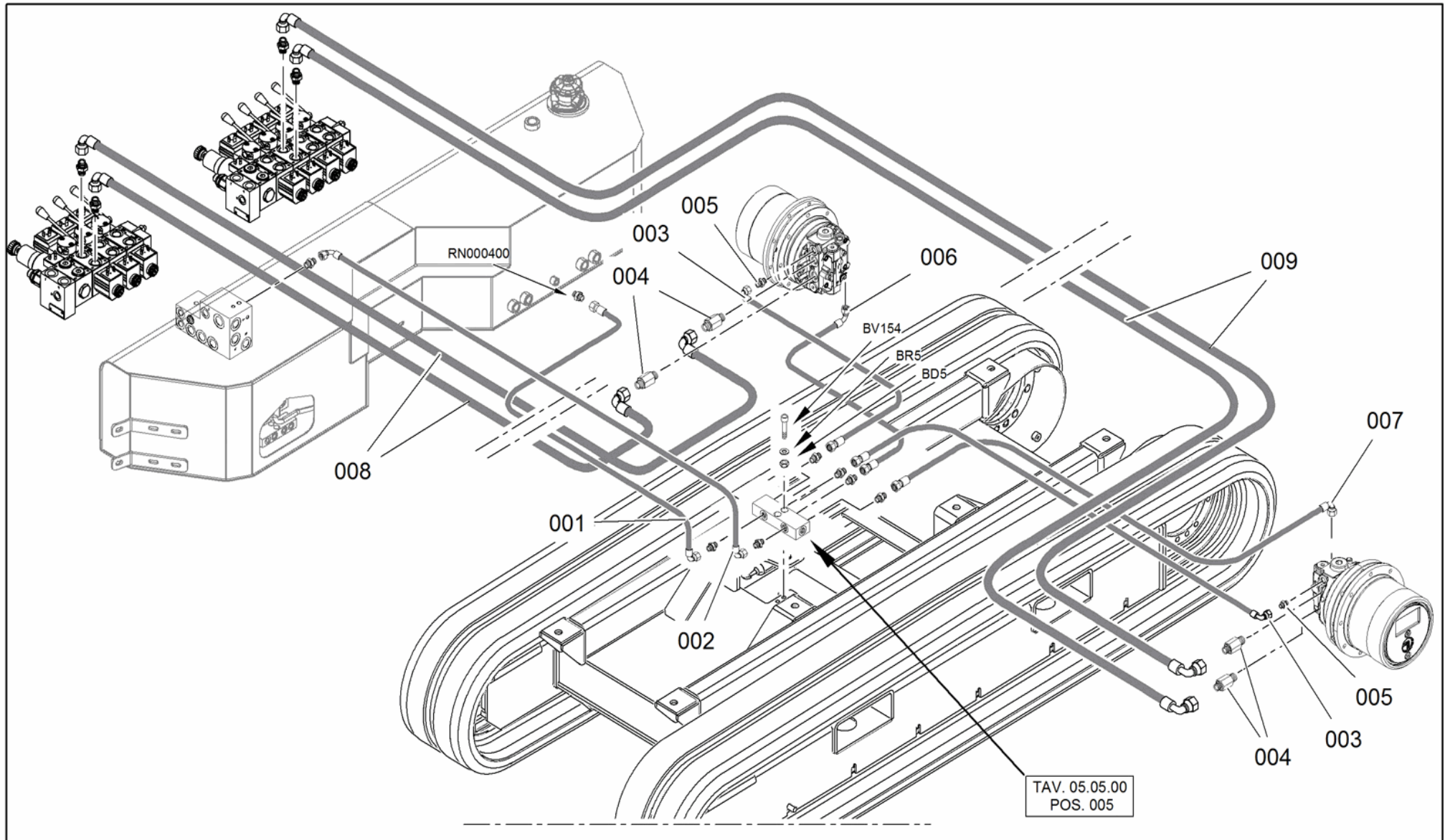





 IMPIANTO IDRAULICO TRAZIONE

HYDRAULIKANLAGE ANTRIEB 

 HYDRAULIC SYSTEM FOR TRACTION

INSTALACIÓN HIDRÁULICA TRACCIÓN 

 SYSTÈME HYDRAULIQUE DE TRACTION

POS Codice	Q.tà	 Descrizione	 Description	 Designation	 Benennung	 Descripción
1 07629300	1 NR	TUBO FLESSIBILE	FLEXIBLE PIPE	TUYAU FLEXIBLE	SCHLAUCH	TUBO FLEXIBLE
2 07629200	1 NR	TUBO FLESSIBILE	FLEXIBLE PIPE	TUYAU FLEXIBLE	SCHLAUCH	TUBO FLEXIBLE
3 07630000	2 NR	TUBO FLESSIBILE	FLEXIBLE PIPE	TUYAU FLEXIBLE	SCHLAUCH	TUBO FLEXIBLE
4 05094100	4 NR	RACCORDO	FITTING	RACCORD	ANSCHLUSS	CONEXIÓN
5 05582000	2 NR	RACCORDO	FITTING	RACCORD	ANSCHLUSS	CONEXIÓN
6 07629800	1 NR	TUBO FLESSIBILE	FLEXIBLE PIPE	TUYAU FLEXIBLE	SCHLAUCH	TUBO FLEXIBLE
7 07629900	1 NR	TUBO FLESSIBILE	FLEXIBLE PIPE	TUYAU FLEXIBLE	SCHLAUCH	TUBO FLEXIBLE
8 07629400	2 NR	TUBO FLESSIBILE	FLEXIBLE PIPE	TUYAU FLEXIBLE	SCHLAUCH	TUBO FLEXIBLE
9 07629500	2 NR	TUBO FLESSIBILE	FLEXIBLE PIPE	TUYAU FLEXIBLE	SCHLAUCH	TUBO FLEXIBLE

 IMPIANTO IDRAULICO ALLARGAMENTO CARRO

 HYDRAULIC SYSTEM UNDERCARRIAGE EXPANSION

 SYSTÈME HYDRAULIQUE EXTENSION DU CHARIOT

HYDRAULIKANLAGE VERBREITERUNG WAGEN 

INSTALACIÓN HIDRAULICA ENSANCHAMIENTO CARRO 

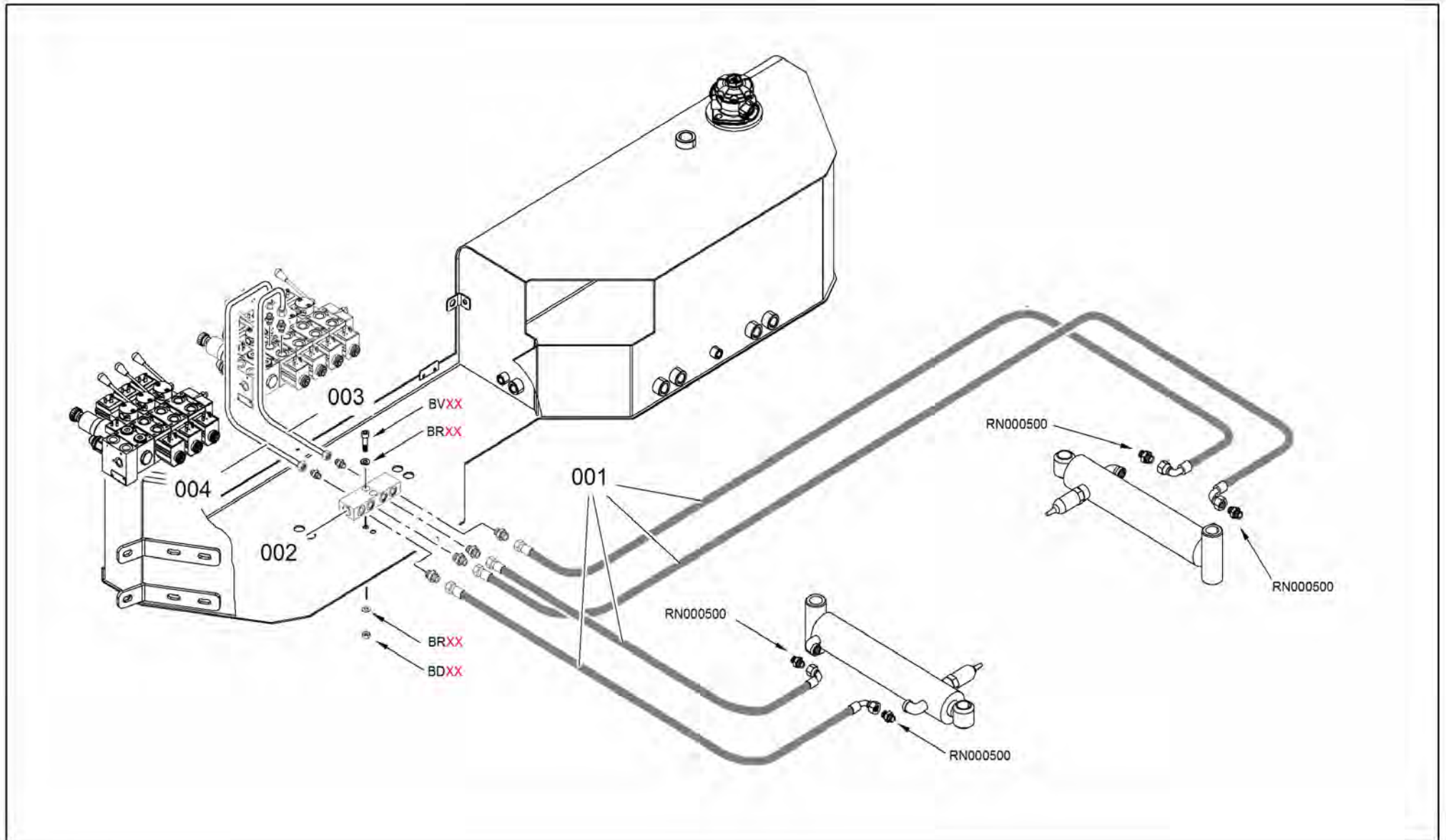





 IMPIANTO IDRAULICO ALLARGAMENTO CARRO

HYDRAULIKANLAGE VERBREITERUNG WAGEN 

 HYDRAULIC SYSTEM UNDERCARRIAGE EXPANSION

INSTALACIÓN HIDRAULICA ENSANCHAMIENTO CARRO 

 SYSTÈME HYDRAULIQUE EXTENSION DU CHARIOT

POS Codice	Q.tà	 Descrizione	 Description	 Designation	 Benennung	 Descripción
1 07628800	4 NR	TUBO FLESSIBILE	FLEXIBLE PIPE	TUYAU FLEXIBLE	SCHLAUCH	TUBO FLEXIBLE
2 04707700	2 NR	COLLETTORE	MANIFOLD	COLLECTEUR	KOLLEKTOR	COLECTOR
3 07581400	1 NR	TUBO RIGIDO	RIGID PIPE	TUYAU RIGIDE	ROHR	TUBO RÍGIDO
4 07581500	1 NR	TUBO RIGIDO	RIGID PIPE	TUYAU RIGIDE	ROHR	TUBO RÍGIDO

 IMPIANTO IDRAULICO CILINDRI STABILIZZATORI

ABSTÜTZUNGSZYLINDER ABSTÜTZUNGSHYDRAULIKZYLINDER 

 STABILIZERS CYLINDERS HYDRAULIC SYSTEM

INSTALACIÓN HIDRAULICA CILINDROS ESTABILIZADORS 

 INSTALLATION HYDRAULIQUE CYLINDRES STABILISATERS

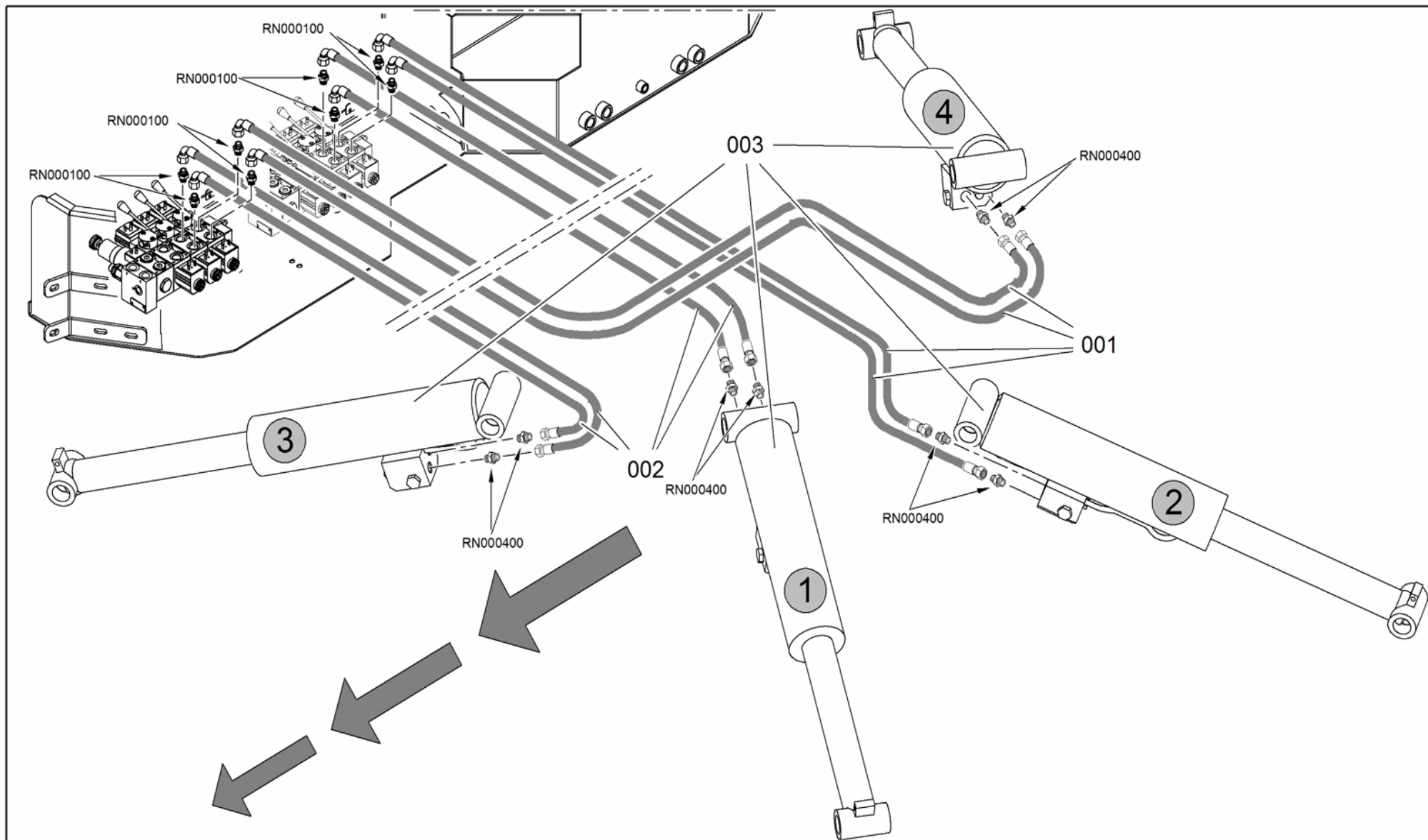





 IMPIANTO IDRAULICO CILINDRI STABILIZZATORI

ABSTÜTZUNGZYLINDER ABSTÜTZUNGSHYDRAULIKZYLINDER 

 STABILIZERS CYLINDERS HYDRAULIC SYSTEM

INSTALACIÓN HIDRAULICA CILINDROS ESTABILIZADORS 

 INSTALLATION HYDRAULIQUE CYLINDRES STABILISATERS

POS Codice	Q.tà	 Descrizione	 Description	 Designation	 Benennung	 Descripció
1 07628600	4 NR	TUBO FLESSIBILE	FLEXIBLE PIPE	TUYAU FLEXIBLE	SCHLAUCH	TUBO FLEXIBLE
2 07628700	4 NR	TUBO FLESSIBILE	FLEXIBLE PIPE	TUYAU FLEXIBLE	SCHLAUCH	TUBO FLEXIBLE
3 275870H2	4 NR	CILINDRO STABILIZZATORE	OUTRIGGER CYLINDER	CYLINDRE STABILISATEUR	STÜTZBEINZYLIN DER	CILINDRO ESTABILIZADOR

 IMPIANTO IDRAULICO 1 - 2 BRACCIO

HYDRAULIKANLAGE 1-2 ARM 

 1-2 ARMS HYDRAULIC SYSTEM

INSTALCIÓN HIDRÁULICA 1-2 BRAZOS 

 SYSTÈME HYDRAULIQUE 1-2 BRAS

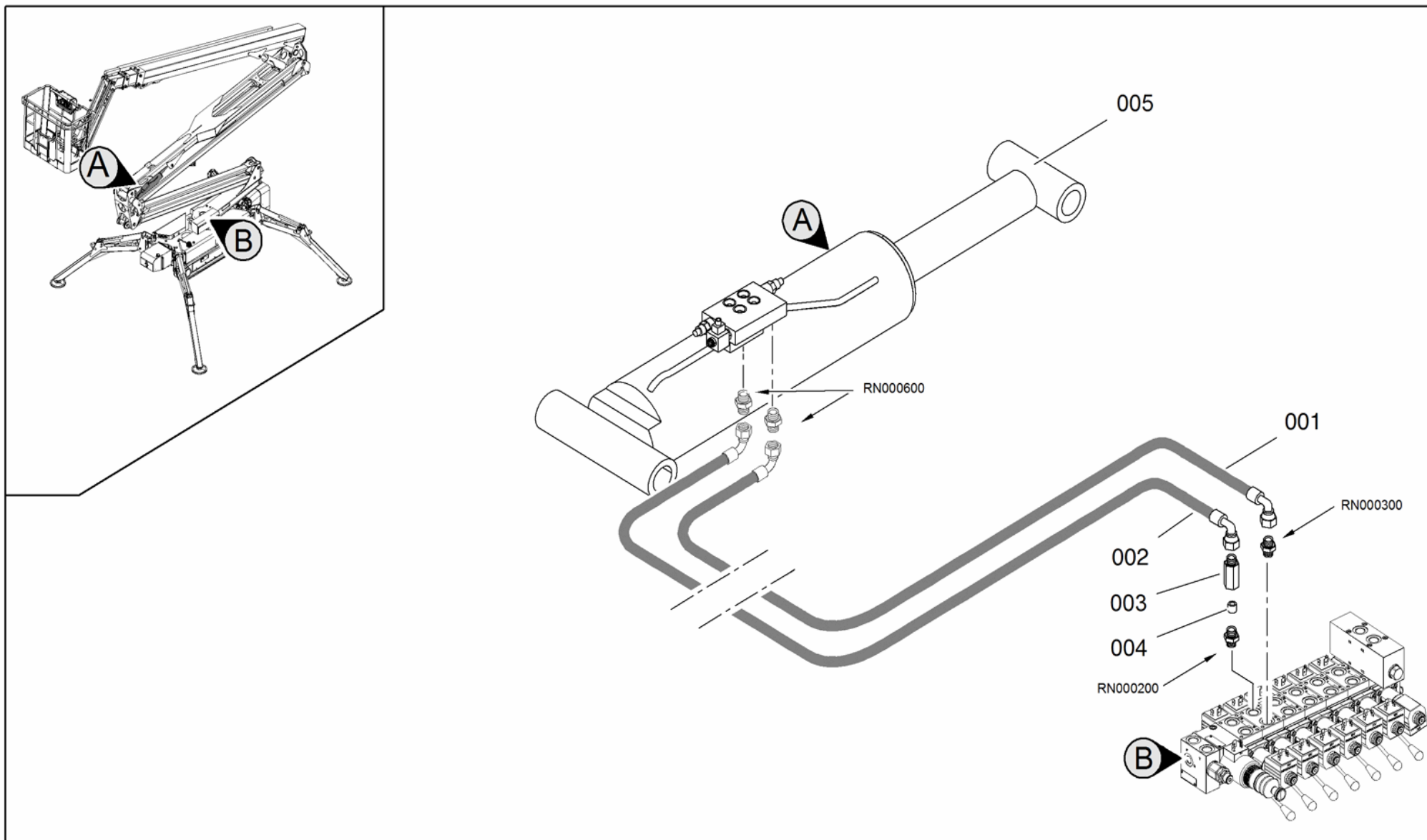





 IMPIANTO IDRAULICO 1 - 2 BRACCIO

HYDRAULIKANLAGE 1-2 ARM 

 1-2 ARMS HYDRAULIC SYSTEM

INSTALACIÓN HIDRÁULICA 1-2 BRAZOS 

 SYSTÈME HYDRAULIQUE 1-2 BRAS

POS Codice	Q.tà	 Descrizione	 Description	 Designation	 Benennung	 Descripción
1 07630100	1 NR	TUBO FLESSIBILE	FLEXIBLE PIPE	TUYAU FLEXIBLE	SCHLAUCH	TUBO FLEXIBLE
2 07630200	1 NR	TUBO FLESSIBILE	FLEXIBLE PIPE	TUYAU FLEXIBLE	SCHLAUCH	TUBO FLEXIBLE
3 07688400	1 NR	RACCORDO PROLUNGA M-F 3/8 H=30 FILETTO UTILE 25	FITTING	RACCORD	ANSCHLUSS	CONEXIÓN
4 07688500	1 NR	PASTIGLIA VNR STROZZATA 3/8 FORO DA Ø=2MM	VALVE	SOUPAPE	VENTIL	VALVULA
5 275200H2	1 NR	CILINDRO 1° E 2° BRACCIO	FIRST AND SECOND ARM CYLINDER	CYLINDRE 1ER ET 2ÈME BRAS	ZYLINDER 1. U. 2. ARM	CILINDRO PRIMERO Y SEGUNDO BRAZO

 IMPIANTO IDRAULICO 3 BRACCIO

HYDRAULIKANLAGE 3 ARM 

 3 ARM HYDRAULIC SYSTEM

INSTALCIÓN HIDRÁULICA 3 BRAZO 

 SYSTÈME HYDRAULIQUE 3 BRAS

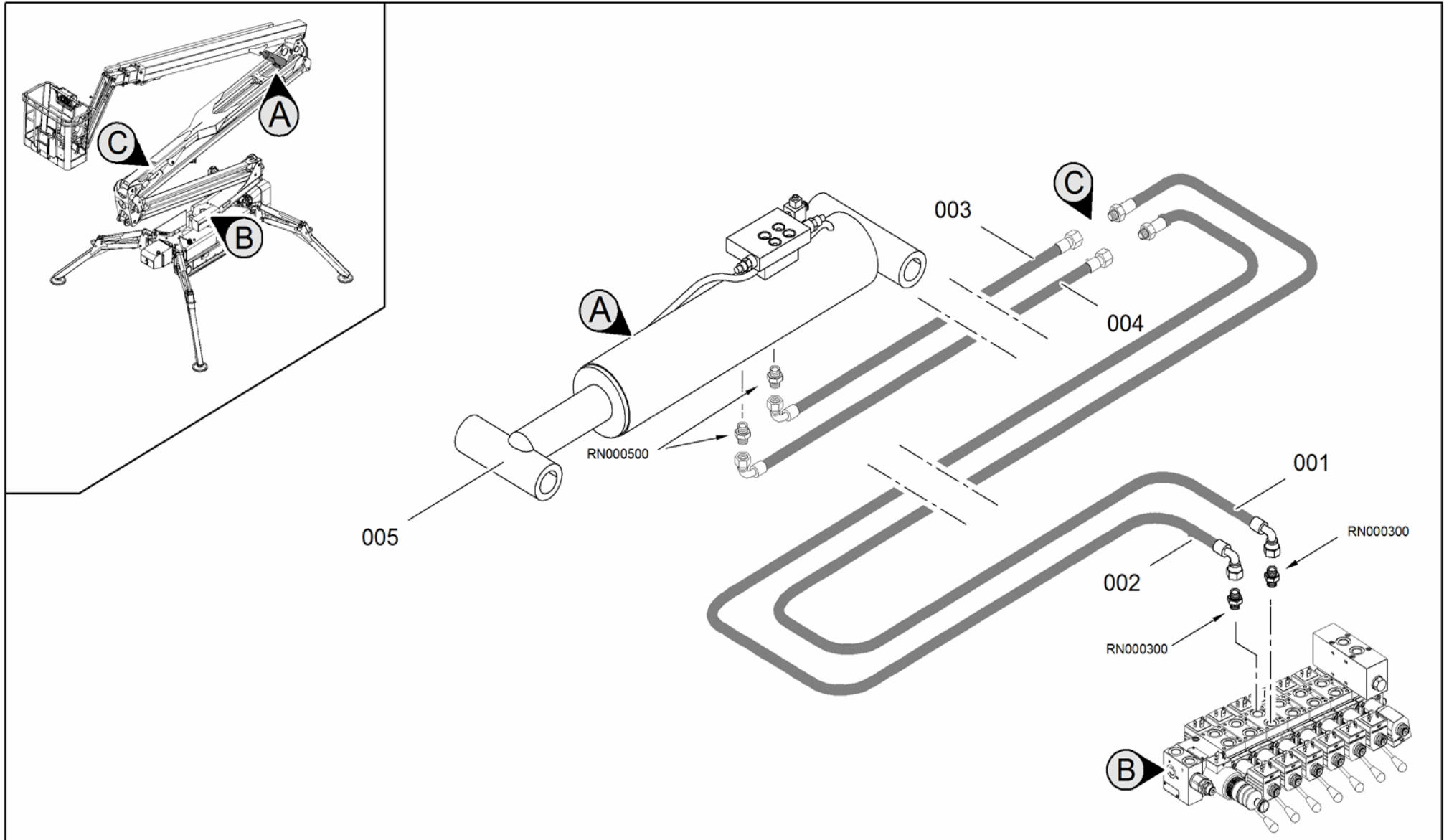





 IMPIANTO IDRAULICO 3 BRACCIO

HYDRAULIKANLAGE 3 ARM 

 3 ARM HYDRAULIC SYSTEM

INSTALACIÓN HIDRÁULICA 3 BRAZO 

 SYSTÈME HYDRAULIQUE 3 BRAS

POS Codice	Q.tà	 Descrizione	 Description	 Designation	 Benennung	 Descripción
1 07630700	1 NR	TUBO FLESSIBILE	FLEXIBLE PIPE	TUYAU FLEXIBLE	SCHLAUCH	TUBO FLEXIBLE
2 07630900	1 NR	TUBO FLESSIBILE	FLEXIBLE PIPE	TUYAU FLEXIBLE	SCHLAUCH	TUBO FLEXIBLE
3 07630800	1 NR	TUBO FLESSIBILE	FLEXIBLE PIPE	TUYAU FLEXIBLE	SCHLAUCH	TUBO FLEXIBLE
4 07631000	1 NR	TUBO FLESSIBILE	FLEXIBLE PIPE	TUYAU FLEXIBLE	SCHLAUCH	TUBO FLEXIBLE
5 275201H2	1 NR	CILINDRO 3° BRACCIO	THIRD ARM CYLINDER	CYLINDRE 3ÈME BRAS	ZYLINDER 3. ARM	CILINDRO TERCERO BRAZO

 IMPIANTO IDRAULICO SFILO

 TELESCOPIC HYDRAULIC SYSTEM

 TELESCOPIQUE HIDRAULIQUE

TELESKOPHYDRAULIK 

INSTALACIÓN EXTENSIÓN HIDRÁULICA 

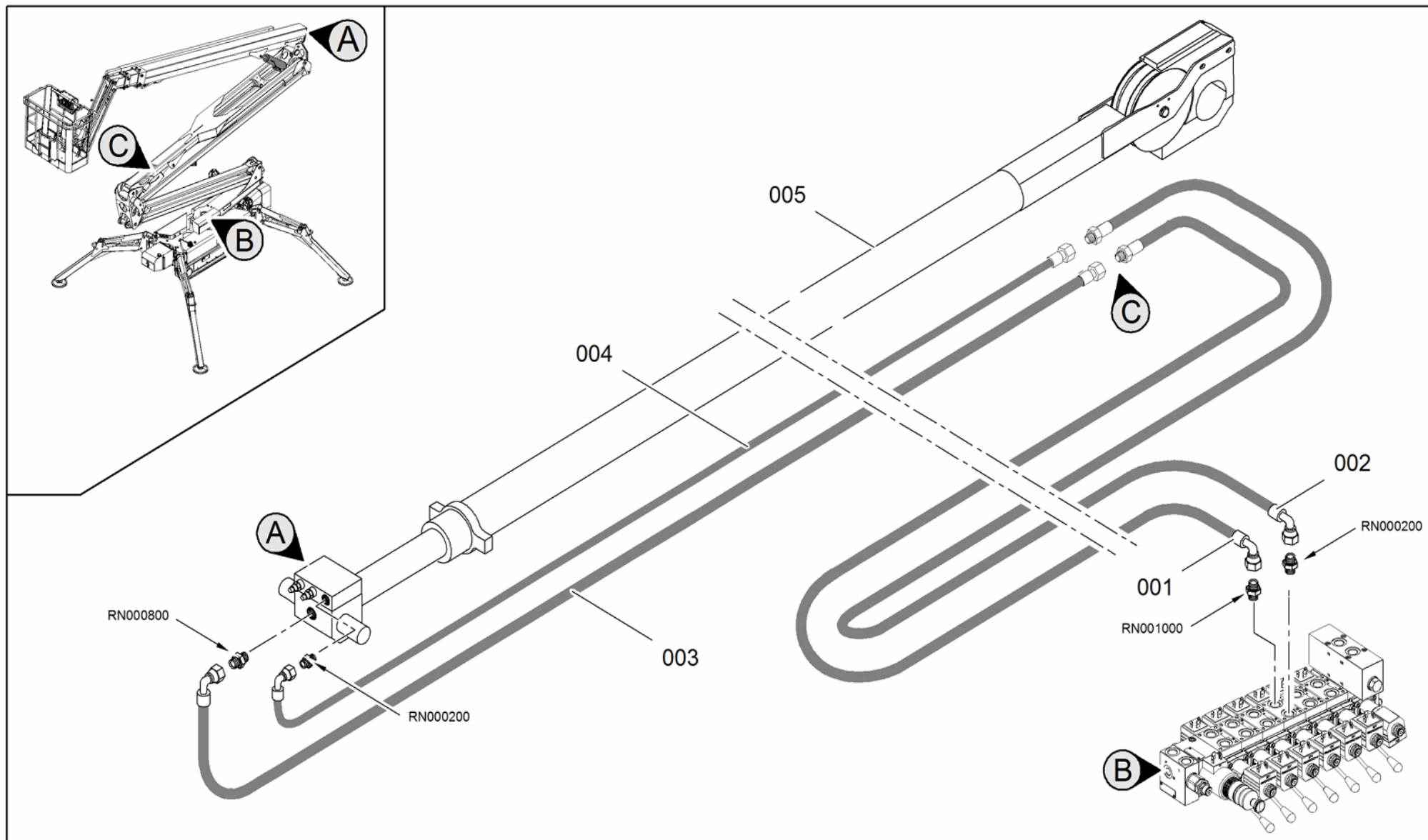







 IMPIANTO IDRAULICO SFILO

TELESKOPHYDRAULIK 

 TELESCOPIC HYDRAULIC SYSTEM

INSTALACIÓN EXTENSIÓN HIDRÁULICA 

 TELESCOPIQUE HIDRAULIQUE

POS Codice	Q.tà	 Descrizione	 Description	 Designation	 Benennung	 Descripcìon
1 07631100	1 NR	TUBO FLESSIBILE	FLEXIBLE PIPE	TUYAU FLEXIBLE	SCHLAUCH	TUBO FLEXIBLE
2 07631300	1 NR	TUBO FLESSIBILE	FLEXIBLE PIPE	TUYAU FLEXIBLE	SCHLAUCH	TUBO FLEXIBLE
3 07631200	1 NR	TUBO FLESSIBILE	FLEXIBLE PIPE	TUYAU FLEXIBLE	SCHLAUCH	TUBO FLEXIBLE
4 07631400	1 NR	TUBO FLESSIBILE	FLEXIBLE PIPE	TUYAU FLEXIBLE	SCHLAUCH	TUBO FLEXIBLE
5 275202H2	1 NR	CILINDRO SFILO	EXTENSION CYLINDER	CYLINDRE BRAS D'EXTRACTION	ZYLINDER TELESKOPAUSS CHUB	CILINDRO EXTENSION

 IMPIANTO JIB

ZYLINDER JIB ARM 

 JIB HYDRAULIC SYSTEM

INSTALACIÓN HIDRÁULICA JIB 



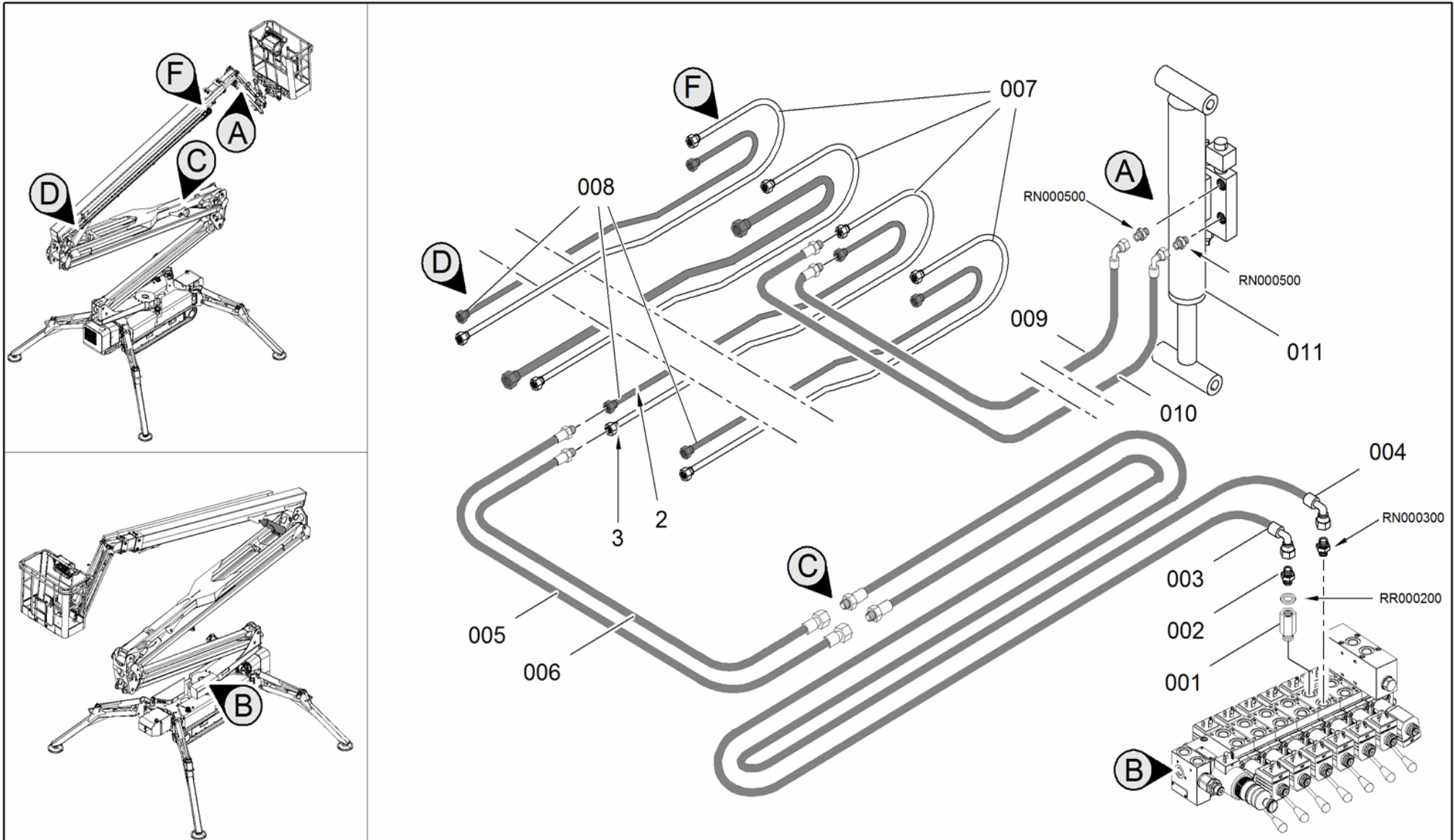

 SYSTÈME HYDRAULIQUE JIB



 IMPIANTO JIB

 ZYLINDER JIB ARM 
 JIB HYDRAULIC SYSTEM

 INSTALACIÓN HIDRÁULICA JIB 
 SYSTÈME HYDRAULIQUE JIB

POS Codice	Q.tà	 Descrizione	 Description	 Designation	 Benennung	 Descripción
1 RS000700	1 NR	RIDUZIONE M-F GAS 1" * 1/2"	REDUCING GAS M-F 1 " * 1/2"	RÉDUCTION M-F GAS 1" * 1/2"	REDUZIERUNG GAS M-F 1"* 1/2"	REDUCCIÓN M-F GAS 1" * 1/2"
2 06786700	1 NR	RACCORDO	FITTING	RACCORD	ANSCHLUSS	CONEXIÓN
3 07631900	1 NR	TUBO FLESSIBILE	FLEXIBLE PIPE	TUYAU FLEXIBLE	SCHLAUCH	TUBO FLEXIBLE
4 07632100	1 NR	TUBO FLESSIBILE	FLEXIBLE PIPE	TUYAU FLEXIBLE	SCHLAUCH	TUBO FLEXIBLE
5 07632000	1 NR	TUBO FLESSIBILE	FLEXIBLE PIPE	TUYAU FLEXIBLE	SCHLAUCH	TUBO FLEXIBLE
6 07632200	1 NR	TUBO FLESSIBILE	FLEXIBLE PIPE	TUYAU FLEXIBLE	SCHLAUCH	TUBO FLEXIBLE
7 07539500	4 NR	TUBO RIGIDO	RIGID PIPE	TUYAU RIGIDE	ROHR	TUBO RÍGIDO
8 07539600	3 NR	TUBO RIGIDO	RIGID PIPE	TUYAU RIGIDE	ROHR	TUBO RÍGIDO
9 07603400	1 NR	TUBO FLESSIBILE	FLEXIBLE PIPE	TUYAU FLEXIBLE	SCHLAUCH	TUBO FLEXIBLE
10 07603500	1 NR	TUBO FLESSIBILE	HOSE	TUYAU FLEXIBLE	SCHLAUCH	TUBO FLEXIBLE
11 270695H2	1 NR	CILINDRO JIB	JIB CYLINDER	CYLINDRE JIB	KORBARMZYLIND ER	CILINDRO JIB

 IMPIANTO IDRAULICO LIVELLAMENTO

HYDRAULIKANLAGE ZYLINDER ARM 



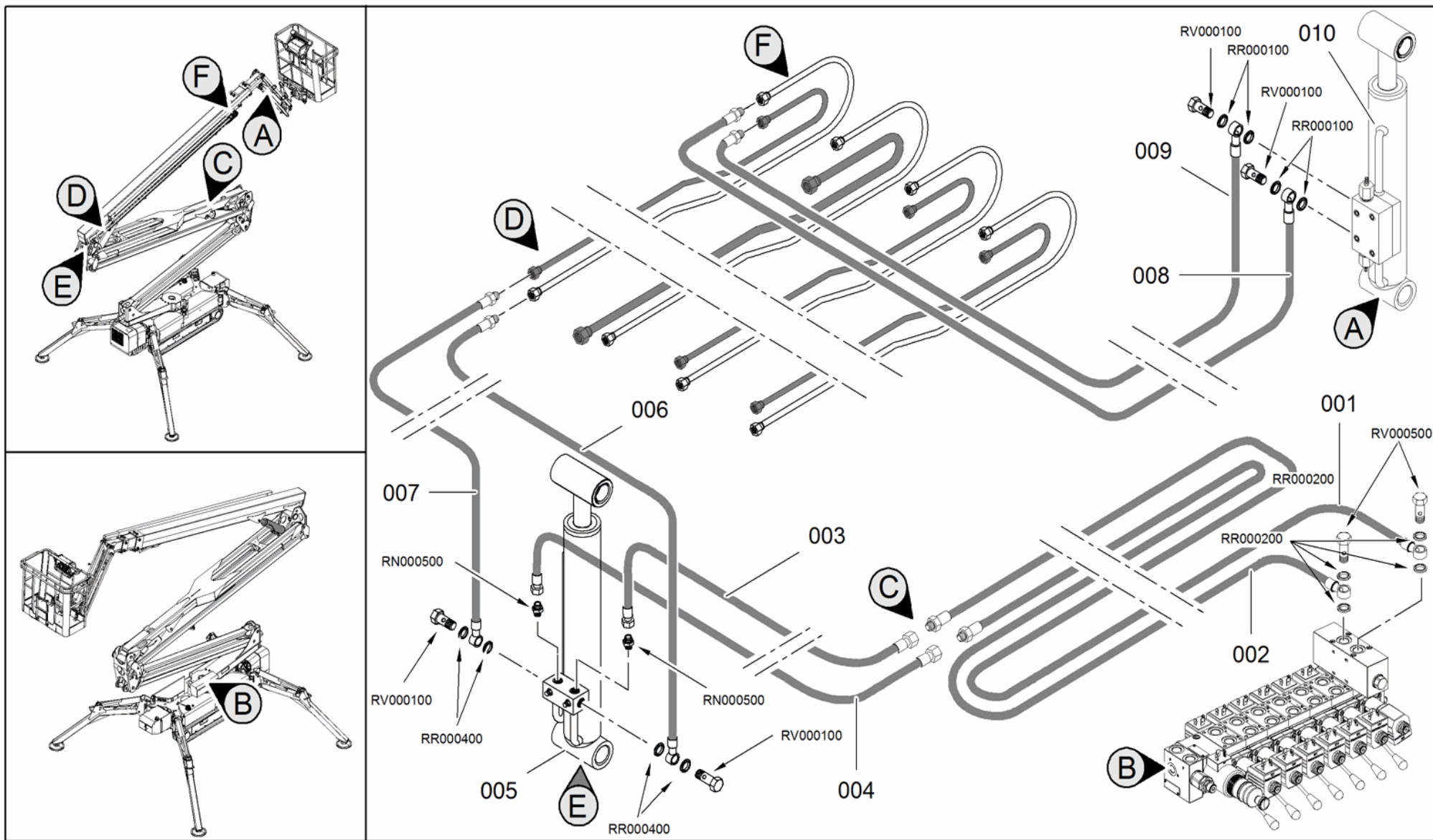

 LEVELING CYLINDERS HYDRAULIC SYSTEM

INSTALACIÓN HIDRÁULICA CILINDROS BRAZOS 

 SYSTÈME HYDRAULIQUE CYLINDRES BRAS



 IMPIANTO IDRAULICO LIVELLAMENTO
HYDRAULIKANLAGE ZYLINDER ARM 
 LEVELING CYLINDERS HYDRAULIC SYSTEM
INSTALACIÓN HIDRÁULICA CILINDROS BRAZOS 
 SYSTÈME HYDRAULIQUE CYLINDRES BRAS

POS Codice	Q.tà	 Descrizione	 Description	 Designation	 Benennung	 Descripción
1 07630300	1 NR	TUBO FLESSIBILE	FLEXIBLE PIPE	TUYAU FLEXIBLE	SCHLAUCH	TUBO FLEXIBLE
2 07630500	1 NR	TUBO FLESSIBILE	FLEXIBLE PIPE	TUYAU FLEXIBLE	SCHLAUCH	TUBO FLEXIBLE
3 07630400	1 NR	TUBO FLESSIBILE	FLEXIBLE PIPE	TUYAU FLEXIBLE	SCHLAUCH	TUBO FLEXIBLE
4 07630600	1 NR	TUBO FLESSIBILE	FLEXIBLE PIPE	TUYAU FLEXIBLE	SCHLAUCH	TUBO FLEXIBLE
5 270693H2	1 NR	CILINDRO LIVELLAMENTO CESTO	BASKET LEVELLING CYLINDER	CYLINDRE NIVELLEMENT PANIER	ZYLINDER KORBNIVELLIERU NG	CILINDRO NIVELACIÓN CESTA
6 07632700	1 NR	TUBO FLESSIBILE	FLEXIBLE PIPE	TUYAU FLEXIBLE	SCHLAUCH	TUBO FLEXIBLE
7 07632800	1 NR	TUBO FLESSIBILE	FLEXIBLE PIPE	TUYAU FLEXIBLE	SCHLAUCH	TUBO FLEXIBLE
8 07603300	1 NR	TUBO FLESSIBILE	HOSE	TUYAU FLEXIBLE	SCHLAUCH	TUBO FLEXIBLE
9 07603600	1 NR	TUBO FLESSIBILE	HOSE	TUYAU FLEXIBLE	SCHLAUCH	TUBO FLEXIBLE
10 273151H2	1 NR	CILINDRO LIVELLAMENTO CESTO SU CESTO	LEVELING CYLINDER BASKET ON BASKET	CYLINDRE NIVELLEMENT PANIER SUR PANIER	ZYLINDER KORBNIVELLIERU NG	CILINDRO NIVELACIÓN CESTA

 IMPIANTO IDRAULICO ROTAZIONE CESTO

HYDRAULIKANLAGE KORBSCHWENKUNG 

 CAGE ROTATION HYDRAULIC SYSTEM

INSTALACIÓN HIDRÁULICA ROTACIÓN CESTA 

 SYSTÈME HYDRAULIQUE ROTATION PANIER

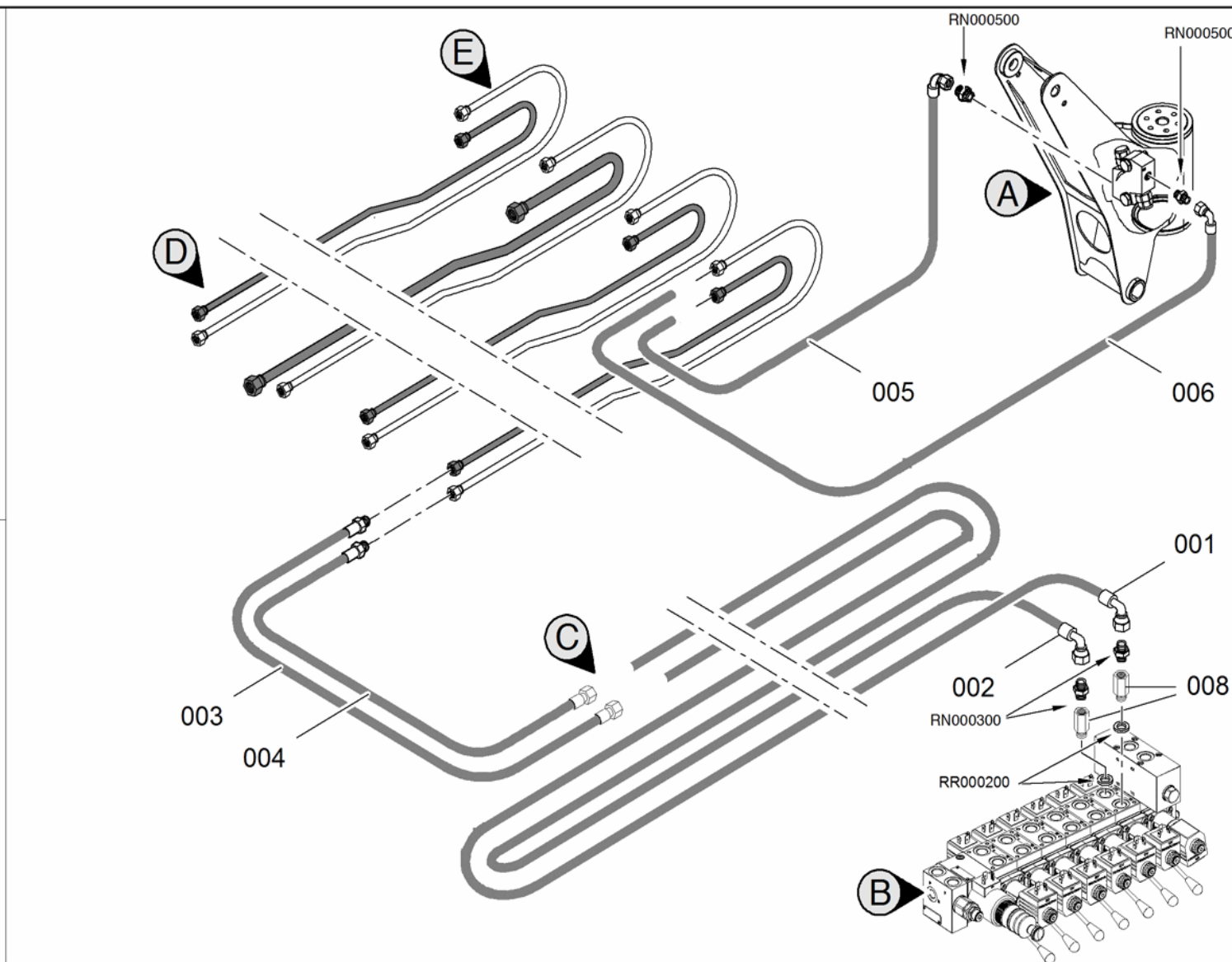
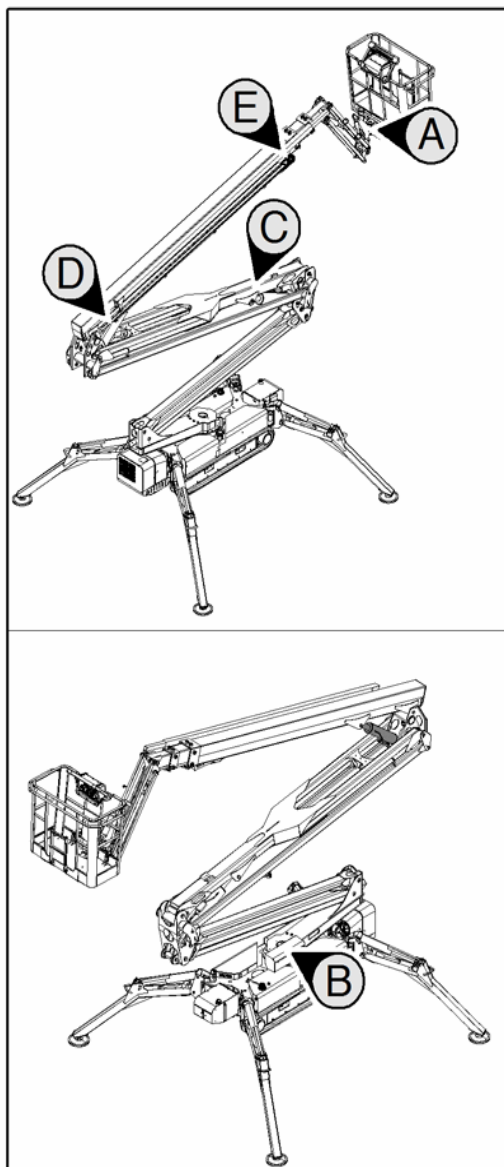





 IMPIANTO IDRAULICO ROTAZIONE CESTO

HYDRAULIKANLAGE KORBSCHWENKUNG 

 CAGE ROTATION HYDRAULIC SYSTEM

INSTALACIÓN HIDRÁULICA ROTACIÓN CESTA 

 SYSTÈME HYDRAULIQUE ROTATION PANIER

POS Codice	Q.tà	 Descrizione	 Description	 Designation	 Benennung	 Descripción
1 07632300	1 NR	TUBO FLESSIBILE	FLEXIBLE PIPE	TUYAU FLEXIBLE	SCHLAUCH	TUBO FLEXIBLE
2 07632500	1 NR	TUBO FLESSIBILE	FLEXIBLE PIPE	TUYAU FLEXIBLE	SCHLAUCH	TUBO FLEXIBLE
3 07632400	1 NR	TUBO FLESSIBILE	FLEXIBLE PIPE	TUYAU FLEXIBLE	SCHLAUCH	TUBO FLEXIBLE
4 07632600	1 NR	TUBO FLESSIBILE	FLEXIBLE PIPE	TUYAU FLEXIBLE	SCHLAUCH	TUBO FLEXIBLE
5 07603800	1 NR	TUBO FLESSIBILE	HOSE	TUYAU FLEXIBLE	SCHLAUCH	TUBO FLEXIBLE
6 07603900	1 NR	TUBO FLESSIBILE	TUBO FLEXIBLE	TUYAU FLEXIBLE	SCHLAUCH	TUBO FLEXIBLE
7 2648910001	1 NR	VALVOLA IDRAULICA	HYDRAULIC VALVE	VALVE HYDRAULIQUE	HYDRAULIKVENTI L	VÁLVULA HIDRÁULICA
8 03149500	2 NR	RACCORDO A COLONNA 3/8" H=20	EXTENSION 3/8" H=20	RACCORD	ANSCHLUSS	CONEXIÓN

 IMPIANTO IDRAULICO ARIA COMPRESSA

HYDRAULIKANLAGE DRUCKLUFT 

 COMPRESSED AIR HYDRAULIC SYSTEM

INSTALACIÓN HIDRÁULICA AIRE COMPRIMIDO 

 SYSTÈME HYDRAULIQUE AIR COMPRIMÉ

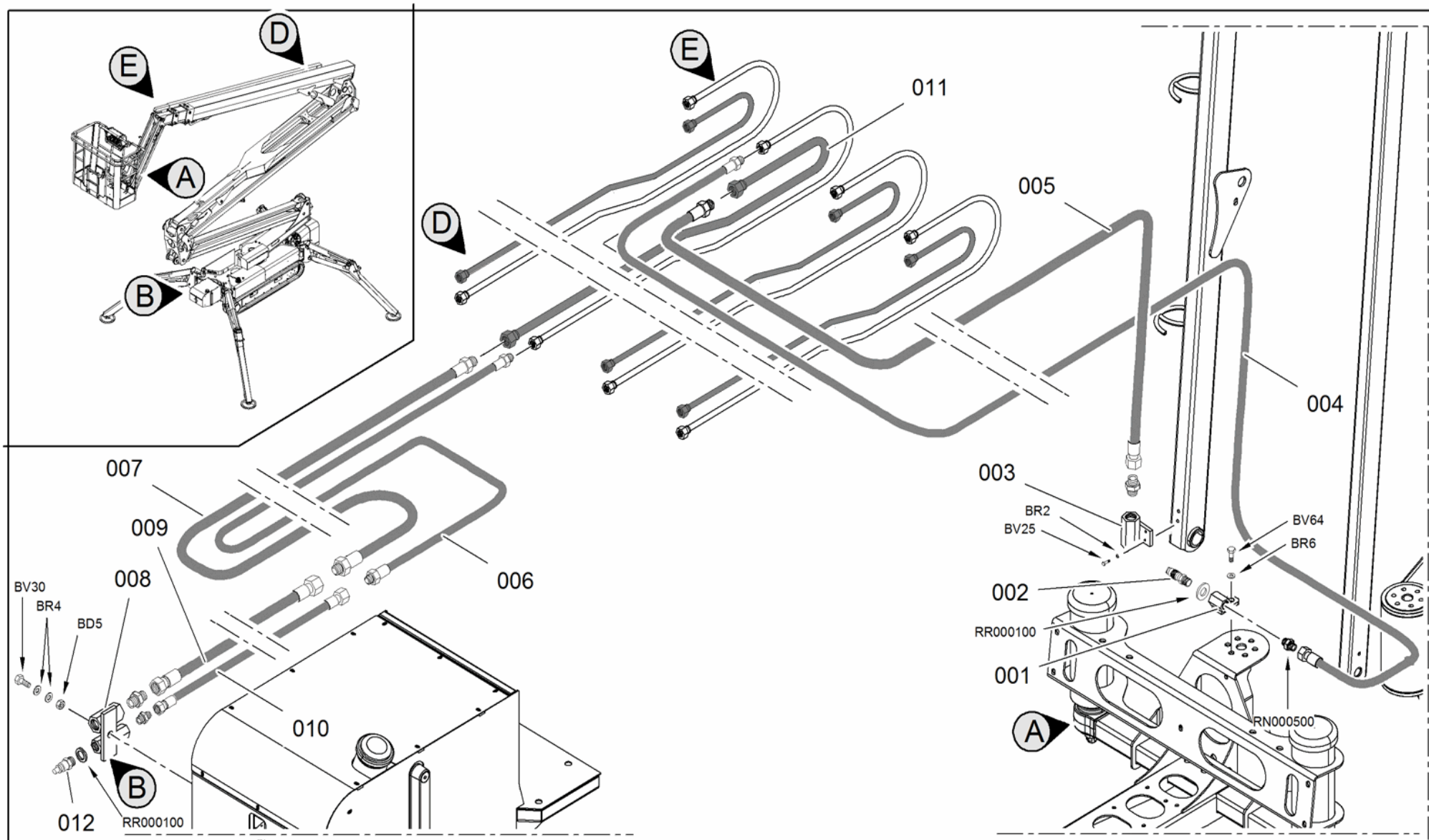





 IMPIANTO IDRAULICO ARIA COMPRESSA

HYDRAULIKANLAGE DRUCKLUFT 

 COMPRESSED AIR HYDRAULIC SYSTEM

INSTALACIÓN HIDRÁULICA AIRE COMPRIMIDO 

 SYSTÈME HYDRAULIQUE AIR COMPRIMÉ

POS Codice	Q.tà	 Descrizione	 Description	 Designation	 Benennung	 Descripción
1 04845100	1 NR	SUPPORTO	SUPPORT	SUPPORT	HALTERUNG	SOPORTE
2 05580200	1 NR	RUBINETTO	FAUCET	ROBINET	WASSERHAHN	GRIFO
3 07611100	1 NR	RACCORDO	HOSE FITTING	TUYAU	ANSCHLUSS	CONEXIÓN
4 07603700	1 NR	TUBO FLESSIBILE	HOSE	TUYAU FLEXIBLE	SCHLAUCH	TUBO FLEXIBLE
5 07604000	1 NR	TUBO FLESSIBILE	FLEXIBLE PIPE	TUYAU FLEXIBLE	SCHLAUCH	TUBO FLEXIBLE
6 07631800	1 NR	TUBO FLESSIBILE	FLEXIBLE PIPE	TUYAU FLEXIBLE	SCHLAUCH	TUBO FLEXIBLE
7 07631600	1 NR	TUBO FLESSIBILE	FLEXIBLE PIPE	TUYAU FLEXIBLE	SCHLAUCH	TUBO FLEXIBLE
8 07611000	1 NR	RACCORDO	PIPE FITTING	TUYAU	ANSCHLUSS	MANGUITO
9 07631500	1 NR	TUBO FLESSIBILE	FLEXIBLE PIPE	TUYAU FLEXIBLE	SCHLAUCH	TUBO FLEXIBLE
10 07631700	1 NR	TUBO FLESSIBILE	FLEXIBLE PIPE	TUYAU FLEXIBLE	SCHLAUCH	TUBO FLEXIBLE
11 07530700	1 NR	TUBO RIGIDO	RIGID PIPE	TUYAU RIGIDE	ROHR	TUBO RÍGIDO
12 05509900	1 NR	INNESTO RAPIDO	QUICK COUPLING	RACCORD RAPIDE	SCHNELLKUPPL UNG	CONEXIÓN RÁPIDA

 CILINDRI

ZYLINDER 



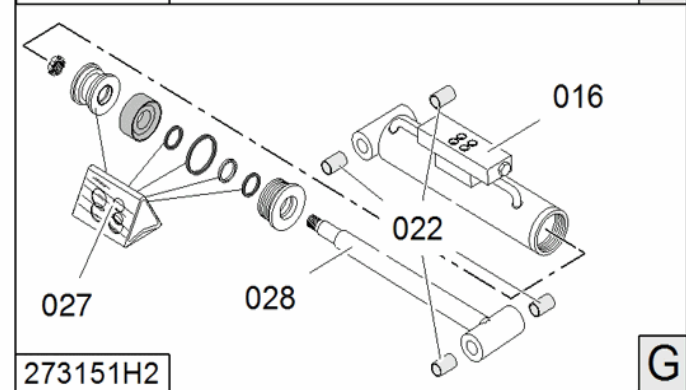
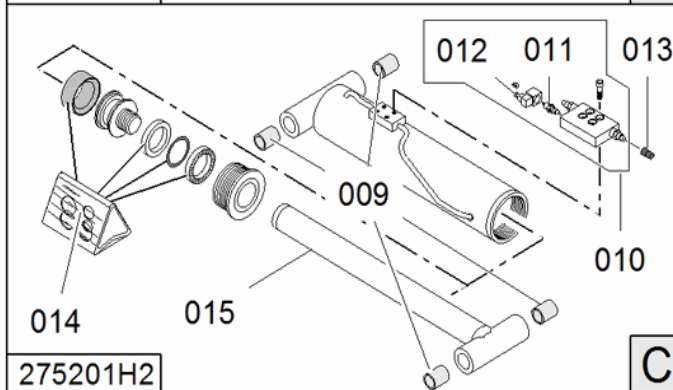
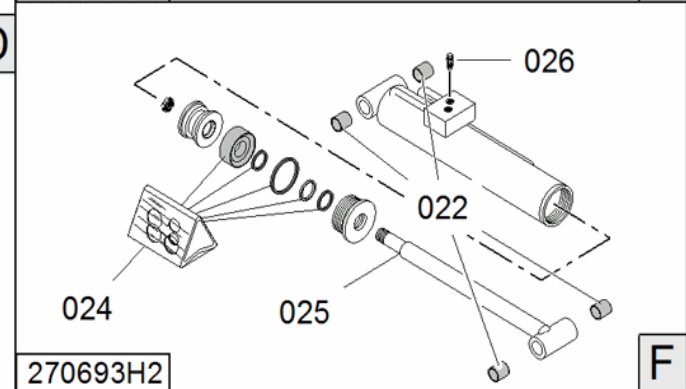
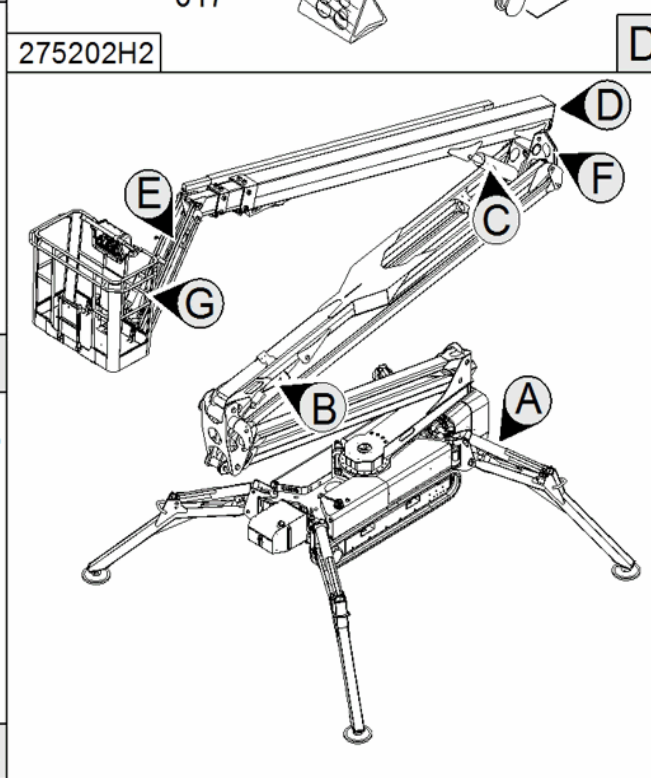
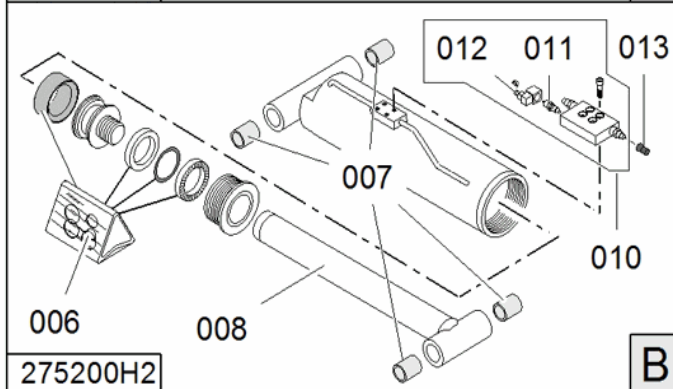
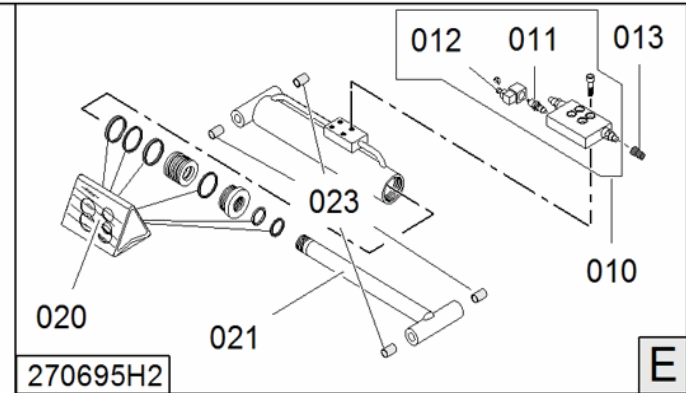
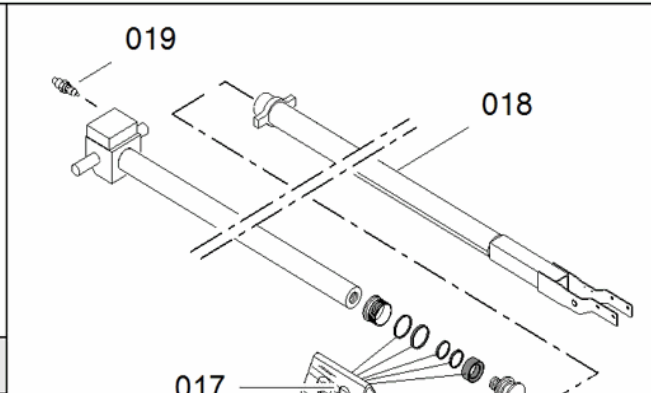
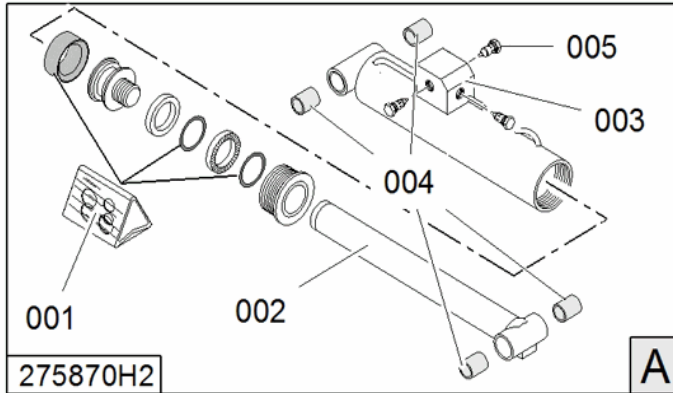

 CYLINDERS

CILINDROS 





 CYLINDRES







 CILINDRIZYLINDER  CYLINDERSCILINDROS  CYLINDRES

POS Codice	Q.tà	 Descrizione	 Description	 Designation	 Benennung	 Descripción
1 2758700002	1 NR	KIT GUARNIZIONI CILINDRO STABILIZZATORE LL2614	SEALING KIT	KIT JOINTS	DICHTSATZ	KIT JUNTAS
2 2758700001	1 NR	STELO CILINDRO STABILIZZATORE LL2614	CYLINDER ROD	TIGE CYLINDRE	ZYLINDERSCHAF T	VÁSTAGO CILINDRO
3 2705540002	1 NR	BLOCCHETTO	BLOCK	BLOC	BLOCK	BLOQUE
4 2627880005	1 NR	BOCCOLA	BUSH	DOUILLE	BUCHSE	CASQUILLO
5 1541150011	1 NR	VALVOLA IDRAULICA	HYDRAULIC VALVE	VALVE HYDRAULIQUE	HYDRAULIKVENTI L	VÁLVULA HIDRÁULICA
6 2752000003	1 NR	KIT GUARNIZIONI CILINDRO 1-2 BRACCIO LL2614	SEALING KIT CYLINDER 1-2 BOOM LL2614-X26JP-X7 70AJ	KIT DE JOINTS	DICHTSATZ	KIT JUNTAS
7 2752000001	1 NR	BOCCOLA AUTOLUBRIFICAN TE TIPO MLG 45X50 L=45 GLACIER	BUSH	DOUILLE	BUCHSE	CASQUILLO
8 2752000002	1 NR	STELO	ROD	TIGE	SCHAFT	VÁSTAGO

 CILINDRIZYLINDER  CYLINDERSCILINDROS  CYLINDRES

POS Codice	Q.tà	 Descrizione	 Description	 Designation	 Benennung	 Descripción
9 2752010001	1 NR	BOCCOLA AUTOLUBRIFICAN TE TIPO MLG 40X45 L=40 GLACIER	BUSH	DOUILLE	BUCHSE	CASQUILLO
10 26119300	1 NR	VALVOLA IDRAULICA	HYDRAULIC VALVE	VALVE HYDRAULIQUE	HYDRAULIKVENTI L	VÁLVULA HIDRÁULICA
11 0552550001	1 NR	ELETTROVALVOL A	SOLENOID VALVE	ÉLECTROVANNE	MAGNETVENTIL	ELECTROVÁLVU LA
12 0552550003	1 NR	BOBINA	COIL	BOBINE	SPULE	BOBINA
13 05576200	6 NR	PROTEZIONE	PROTECTION	PROTECTION	SCHUTZ	PROTECCIÓN
14 2752010003	1 NR	KIT GUARNIZIONI CILINDRO 3 BRACCIO LL2614	SEAL KIT	KIT DE JOINTS	DICHTSATZ	KIT JUNTAS
15 2752010002	1 NR	STELO	ROD	TIGE	SCHAFT	VÁSTAGO
16 2731510003	1 NR	VALVOLA IDRAULICA	HYDRAULIC VALVE	VALVE HYDRAULIQUE	HYDRAULIKVENTI L	VÁLVULA HIDRÁULICA
17 2752020001	1 NR	KIT GUARNIZIONI	GASKET KIT	KIT JOINTS	DICHTUNGSSATZ	KIT GUARNICIONES
18 2752020002	1 NR	STELO	ROD	TIGE	SCHAFT	VÁSTAGO
19 2630690003	1 NR	VALVOLA IDRAULICA	HYDRAULIC VALVE	VALVE HYDRAULIQUE	HYDRAULIKVENTI L	VÁLVULA HIDRÁULICA

 CILINDRIZYLINDER  CYLINDERSCILINDROS  CYLINDRES

POS Codice	Q.tà	 Descrizione	 Description	 Designation	 Benennung	 Descripción
20 2706950001	1 NR	KIT GUARNIZIONI CILINDRO JIB	SEAL KIT CYLINDER JIB	KIT DE JOINTS	DICHTUNGSSATZ	KIT JUNTAS CILINDRO JIB
21 2706950002	1 NR	STELO CILINDRO JIB	ROD CYLINDER JIB	TIGE DE CYLINDRE JIB	KORBARM ZYLINDERSCHAF T	VASTAGO CILINDRO JIB
22 2627890006	4 NR	BOCCOLA	BUSH	DOUILLE	BUCHSE	CASQUILLO
23 2627910006	4 NR	BOCCOLA	BUSH	DOUILLE	BUCHSE	CASQUILLO
24 2706930001	1 NR	KIT GUARNIZIONI CILINDRO LIVELLAMENTO SU RINVIO	CYLINDER GASKET KIT	KIT DE JOINTS CYLINDRE NIVELLEMENT	DICHTSATZ ZYLINDER AUSNIVELLIERUN G	KIT DE JUNTAS CILINDRO NIVELACIÓN
25 2706930002	1 NR	STELO CILINDRO LIVELLAMENTO SU RINVIO	ROD CYLINDER	TIGE CYLINDRE	ZYLINDERSCHAF T	VASTAGO CILINDRO
26 2588290008	2 NR	VITE	SCREW	VIS	SCHRAUBE	TORNILLO
27 2706940001	1 NR	KIT GUARNIZIONI CILINDRO LIVELLAMENTO SU CESTO	CYLINDER GASKET KIT	KIT DE JOINTS CYLINDRE NIVELLEMENT	DICHTSATZ	KIT JUNTAS
28 2706940002	1 NR	STELO CILINDRO LIVELLAMENTO SU CESTO	BASKET LEVELING CYLINDER ROD ON BASKET	CYLINDRE TIGE	ZYLINDERSCHAF T	VASTAGO CILINDRO

 COMPONENTI IMPIANTO ELETTRICO

KOMPONENTEN ELEKTROANLAGE 

 ELECTRICAL SYSTEM COMPONENTS

COMPONENTES INSTALACIÓN ELÉCTRICA 

 COMPOSANTS INSTALLATION ÉLECTRIQUE

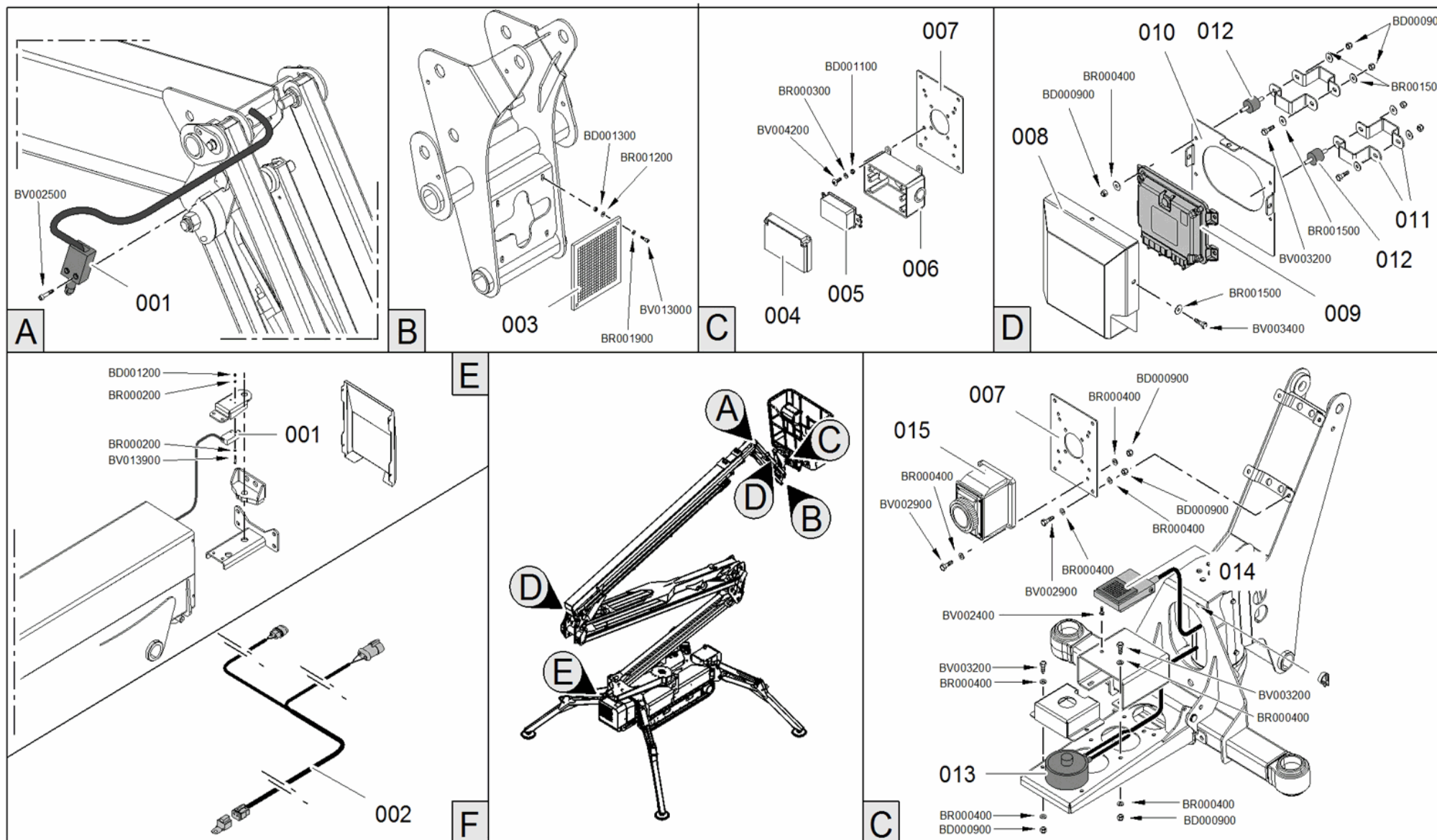





 COMPONENTI IMPIANTO ELETTRICO

 KOMponentEN ELEKTROANLAGE

 ELECTRICAL SYSTEM COMPONENTS

 COMPONENTES INSTALACIÓN ELÉCTRICA





 COMPOSANTS INSTALLATION ÉLECTRIQUE

POS Codice	Q.tà	 Descrizione	 Description	 Designation	 Benennung	 Descripción
1 1679900012	1 NR	MICROINTERRUTTORI 2 CONTATTI NC/NO TESTINA ROTELLA ACCIAIO CAVO LUNGO 5 METRI	MICRO SWITCH CONTACT 2 NC / NO HEAD STEEL WHEEL LONG CABLE 5 METER	MICROINTERRUPTEUR	MIKROSCHALTER	MICROINTERRUPTOR
3 1679890001	1 NR	CATARIFRANGENTE 100X100 MM	REFLECTOR 100X100 MM	CATADIOPTRE	REFLEKTOR	CATADIÓPTRICO
4 27073800	1 NR	COVER PRESE USA AL CESTO, RECEPTACLE BOX PART N°:1671207	COVER US SOCKETS TO BASKET, RECEPTACLE BOX PART N°:1671207	PRETECTION	SCHUTZ	PROTECCIÓN
5 27073900	1 NR	PLUG PRESE USA AL CESTO, RECEPTACLE PART N°:4460346	US SOCKETS TO BASKET, RECEPTACLE PART N°:4460346	PRISE	STECKDOSE	ENCHUFE
6 27073700	1 NR	BOX PRESE USA AL CESTO, RECEPTACLE PART N°:0861731	US SOCKET BOX TO BASKET, RECEPTACLE PART N°:0861731	BOX PRISES	SCHACHTEL STECKDOSEN	CAJA ENCHUFES
7 077089H2	1 NR	PIASTRA FISSAGGIO PRESE SU CESTO TTC	FIXING PLATE PLUGS ON BASKET TTC	PLAQUE	PLATTE	PLACA

 COMPONENTI IMPIANTO ELETTRICO

 KOMponenten ELEKTROANLAGE 
 ELECTRICAL SYSTEM COMPONENTS





 COMPONENTES INSTALACIÓN ELÉCTRICA 
 COMPOSANTS INSTALLATION ÉLECTRIQUE

POS Codice	Q.tà	 Descrizione	 Description	 Designation	 Benennung	 Descripción
8 077092H2	1 NR	CARTER PROTEZIONE SCHEDELLA DI CARICO TTC HINOWA GREY	PROTECTION	PROTECTION	SCHUTZ	PROTECCION
9 1772950016	2 NR	SCHEDELLA ELETTRONICA DI CONTROLLO 48XS PROGRAMMATA PER GESTIONE A RICAMBIO	ELECTRONIC BOARD OF CONTROL 48XS PROGRAMMED FOR SPARE PARTS	CARTE ÉLECTRONIQUE	ELEKTRONISCHE PLATINE	TARJETA ELECTRÓNICA
10 077091H2	1 NR	PIASTRA FISSAGGIO SCHEDELLA DI CARICO TTC	FIXING PLATE LOAD CELL CARD TTC	PLAQUE	PLATTE	PLACA
11 077090H2	8 NR	COLLARE FISSAGGIO SCHEDELLA DI CARICO TTC	COLLAR FIXING SHEET LOAD CELL TTC	BRIDE	BUNDRING	ABRAZADERA
12 04152300	4 NR	SUPPORTO ELASTICO SUPERIORE RADIATORE -	SPRING SUPPORT	SUPPORT ELASTIQUE	FEDERAUFLAGE	SOPORTE ELASTICO

 COMPONENTI IMPIANTO ELETTRICO

 KOMponenten ELEKTROANLAGE 
 ELECTRICAL SYSTEM COMPONENTS

 COMPONENTES INSTALACIÓN ELÉCTRICA 
 COMPOSANTS INSTALLATION ÉLECTRIQUE

POS Codice	Q.tà	 Descrizione	 Description	 Designation	 Benennung	 Descripción
13 17669800	1 NR	SENSORE CELLA DI CARICO 4-20MA COMPLETO DI CAVO E CONNETTORI M12 (MK2)	SENSOR LOAD CELL 4-20MA WITH CABLE AND CONNECTORS M12 (MK2 VERSION)	CELLULE DE CHARGE (MK2)	MESSDOSE (MK2)	CÉLULA DE CARGA (MK2)
14 1772950015	1 NR	INTERRUTTORE A PEDALE COMPLETO DI CAVO E CONNETTORE TRE VIE CONTATTO NC/NO	FOOT SWITCH COMPLETE WITH CABLE AND CONNECTOR THREE-WAY CONTACT NC/NO	INTERRUPTEUR	SCHALTER	INTERRUPTOR
15 1585570005	1 NR	PRESA ELETTRICA 230V	ELECTRICAL SOCKET 230V	PRISE ÉLECTRIQUE	STECKDOSE	ENCHUFE ELÉCTRICO
15 1591700002	1 NR	PRESA ELETTRICA 110V	ELECTRICAL SOCKET 110V	PRISE ÉLECTRIQUE 110V	STECKDOSE 110V	ENCHUFE ELÉCTRICO 110V

 COMPONENTI IMPIANTO ELETTRICO

KOMPONENTEN ELEKTROANLAGE 

 ELECTRICAL SYSTEM COMPONENTS

COMPONENTES INSTALACIÓN ELÉCTRICA 

 COMPOSANTS INSTALLATION ÉLECTRIQUE

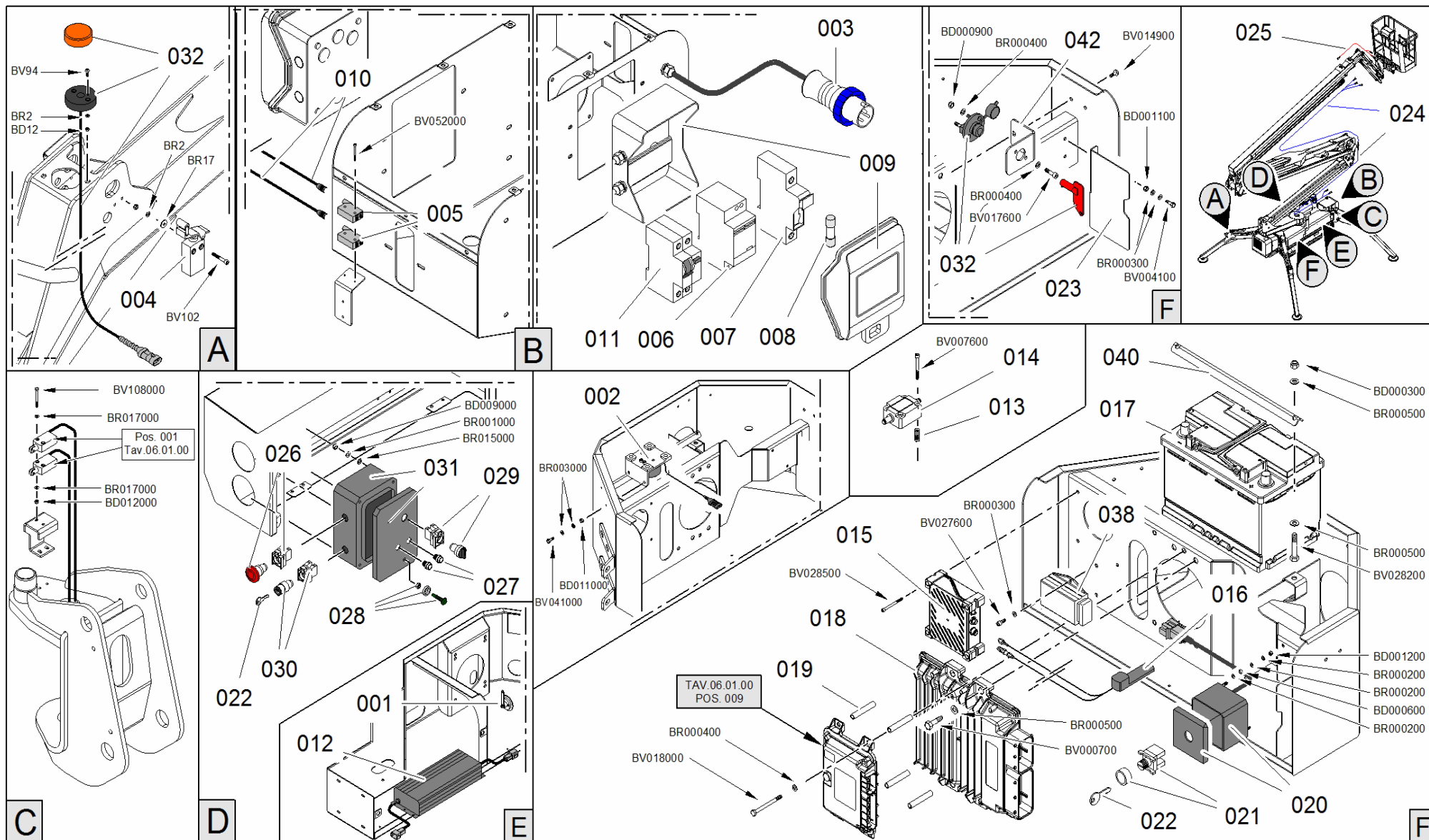





 COMPONENTI IMPAINTO ELETTRICO

 KOMponenten ELEKTROANLAGE

 ELECTRICAL SYSTEM COMPONENTS

 COMPONENTES INSTALACIÓN ELÉCTRICA

 COMPOSANTS INSTALLATION ÉLECTRIQUE

POS Codice	Q.tà	 Descrizione	 Description	 Designation	 Benennung	 Descripción
1 04834500	1 NR	CLAXON	HORN	KLAXON	HORN	BOCINA
2 06639100	1 NR	AVVISATORE ACUSTICO	ACOUSTIC ALARM	BUZZER	SUMMER	ZUMBADOR
3 1757250001	1 NR	SPINA VOLANTE 230V 16A	FREE PLUG 230V 16A	FICHE	STECKER	ENCHUFE
3 1757250003	1 NR	SPINA VOLANTE 110V 16A	FREE PLUG 110V 16A	CHEVILLE	STIF	CLAVIJA
3 27074000	1 NR	TERMINAL PRESA USA A TERRA, CONN PLUG PART N°:4460138	TERMINAL GROUND SOCKET USA, CONN PLUG PART N °: 4460138	CONNECTEUR	VERBINDER	CONECTOR
4 1770740001	1 NR	MICROINTERRUTT ORE 2 CONTATTI NC/NO TESTINA BRACCIO E ROTELLA IN ACCIAIO CAVO LUNGO 2 METRI	2 NC/NO CONTACTS MICROSWITCH HEAD ARM AND WHEEL STEEL LONG CABLE 2M	MICROINTERRUP TEUR	MIKROSCHALTER	MICROINTERRUP TOR
5 1591270001	1 NR	FOTOCPELLULA	PHOTOCELL	CELLULE PHOTO-ÉLECTRI QUE	PHOTOZELLE	FOTOCÉLULA
6 1757250006	1 NR	TELERUTTORE 4POLI 63A CA/CC	RELAY	RELAIS	RELAIS	RELÉ





 COMPONENTI IMPAINTO ELETTRICO

KOMPONENTEN ELEKTROANLAGE 

 ELECTRICAL SYSTEM COMPONENTS

COMPONENTES INSTALACIÓN ELÉCTRICA 





 COMPOSANTS INSTALLATION ÉLECTRIQUE

POS Codice	Q.tà	 Descrizione	 Description	 Designation	 Benennung	 Descripción
7 1730720015	1 NR	PORTAFUSIBILE A TUBO 220/110V	FUSE HOLDER TUBE 220/110V	BOÎTE À FUSIBLES	SICHERUNGSKA STEN	PORTAFUSIBLES
8 1730720017	1 NR	FUSIBILE A TUBO 10A	TUBE FUSE 10A	FUSIBLE	SICHERUNG	FUSIBLE
9 1757250008	1 NR	SCATOLA ELETTRICO PLASTICA 6 MODULI BI COPERCHIO TRASPARENTE	ELECTRICAL BOX	BOÎTE ÉLECTRIQUE	SCHALTKASTEN	CAJA ELÉCTRICA
10 159127000101	1 NR	CAVO ELETTRICO	ELECTRIC CABLE	CÂBLE ÉLECTRIQUE	ELEKTROKABEL	CABLE ELÉCTRICO
11 1556350063	1 NR	INTERUTTORE AUTOMATICO MAGNETOTERMI CO 110-120V 25A (FINO A C170000355 MONTATO C16 SU MACCHINE 120V)	AUTOMATIC THERMAL SWITCH 110-120V 25A (UNTIL C170000355 MOUNTED C16 ON 120V MACHINES)	INTERRUPTEUR	SCHALTER	INTERRUPTOR

 COMPONENTI IMPAINTO ELETTRICO

 KOMponenten ELEKTROANLAGE 
 ELECTRICAL SYSTEM COMPONENTS





 COMPONENTES INSTALACIÓN ELÉCTRICA 
 COMPOSANTS INSTALLATION ÉLECTRIQUE

POS Codice	Q.tà	 Descrizione	 Description	 Designation	 Benennung	 Descripción
12 1757260008	1 NR	CABLAGGIO DA BATTERIA A CARICABATTERIA CON DIODO E CONNETTORE WEIDMULLER	WIRING FROM BATTERY TO CHARGER WITH DIODE AND CONNECTOR WEIDMULLER	CÂBLAGE	VERKABELUNG	CABLEADO
12 17572600081	1 NR	CONNETTORE DEUTSCH 2 VIE COMPLETO DI DIODO CON PROTEZIONE	DEUTSCH CONNECTOR 2 WAYS OF COMPLETE WITH PROTECTION DIODE	CONNECTEUR	VERBINDER	CONECTOR
12 1773980001	1 NR	ALIMENTATORE ELETTRONICO 285W REGOLABILE IP65 PER BATTERIE 55-75 AH COMPLETO DI CONNETTORI	ELECTRONIC BALLAST	ALIMENTATEUR ÉLECTRONIQUE	ELEKTRONISCHE S NETZGERÄT	ALIMENTADOR ELETRÓNICO
13 05444800	4 NR	MOLLA	SPRING	RESSORT	FEDER	MUELLE
14 17708000	1 NR	INCLINOMETRO	INCLINOMETER	INCLINOMÈTRE	NEIGUNGSSENS OR	INCLINÓMETRO

 COMPONENTI IMPAINTO ELETTRICO

 KOMponenten ELEKTROANLAGE 
 ELECTRICAL SYSTEM COMPONENTS





 COMPONENTES INSTALACIÓN ELÉCTRICA 
 COMPOSANTS INSTALLATION ÉLECTRIQUE

POS Codice	Q.tà	 Descrizione	 Description	 Designation	 Benennung	 Descripción
15 07844200	1 NR	RESISTENZA 120 OHM PER CONNETTORE SERIALE RS-232	120 OHM RESISTANCE FOR CONNECTOR RS-232	120 OHM RESISTANCE POUR CONNECTEUR RS-232	120 OHM WIDERSTAND FÜR VERBINDER RS-232	RESISTENCIA 120 OHM PARA CONECTOR RS-232
15 17162400	1 NR	KIT RAMHINO	RAMHINO KIT	KIT RAMHINO	KIT RAMHINO	KIT RAMHINO
15 17162500	1 NR	CAVO RAMHINO	CABLE	CÂBLE	KABEL	CABLE
15 1772950017	1 NR	MODEM ESTERNO GPS-4G CAN PROGRAMMATO PER GESTIONE A RICAMBIO	MODEM GPS-4G CAN TO SPARE	MODEM	MODEM	MODEM
15 26582800	1 NR	ADATTATORE PCAN-USB (IPEH-002021)	ADAPTER	ADAPTEUR	ADAPTER	ADAPTADOR
16 27396100	1 NR	ANTENNA	AERIAL	ANTENNE	ANTENNE	ANTENA
17 27599000	1 NR	BATTERIA	BATTERY	BATTERIE	BATTERIE	BATERÍA
17 27668600	1 NR	BATTERIA AGM S&S 12V 60AH 680A L02	BATTERY AGM S&S 12V 60AH 680A L02	BATTERIE AGM S&S 12V 60AH 680A L02	BATTERIE AGM S&S 12V 60AH 680A L02	BATERÍA AGM S&S 12V 60AH 680A L02

 COMPONENTI IMPAINTO ELETTRICO

 KOMponenten ELEKTROANLAGE 
 ELECTRICAL SYSTEM COMPONENTS





 COMPONENTES INSTALACIÓN ELÉCTRICA 
 COMPOSANTS INSTALLATION ÉLECTRIQUE

POS Codice	Q.tà	 Descrizione	 Description	 Designation	 Benennung	 Descripción
18 07844200	1 NR	RESISTENZA 120 OHM PER CONNETTORE SERIALE RS-232	120 OHM RESISTANCE FOR CONNECTOR RS-232	120 OHM RESISTANCE POUR CONNECTEUR RS-232	120 OHM WIDERSTAND FÜR VERBINDER RS-232	RESISTENCIA 120 OHM PARA CONECTOR RS-232
18 17162400	1 NR	KIT RAMHINO	RAMHINO KIT	KIT RAMHINO	KIT RAMHINO	KIT RAMHINO
18 17162500	1 NR	CAVO RAMHINO	CABLE	CÂBLE	KABEL	CABLE
18 1772950018	1 NR	SCHEDA ELETTRONICA DI CONTROLLO 580 PROGRAMMATA PER GESTIONE A RICAMBIO	ELECTRONIC BOARD OF CONTROL 580 PROGRAMMED FOR SPARE PARTS	CARTE ÉLECTRONIQUE	ELEKTRONISCHE PLATINE	TARJETA ELECTRÓNICA
18 26582800	1 NR	ADATTATORE PCAN-USB (IPEH-002021)	ADAPTER	ADAPTEUR	ADAPTER	ADAPTADOR
19 077087Y2	4 NR	DISTANZIALE FISSAGGIO SCHEDA CELLA (ZINCATO)	SPACER	ENTRETOISE	DISTANZSTÜCK	DISTANCIADOR
19 077087Y2	1 NR	DISTANZIALE FISSAGGIO SCHEDA CELLA (ZINCATO)	SPACER	ENTRETOISE	DISTANZSTÜCK	DISTANCIADOR

 COMPONENTI IMPAINTO ELETTRICO

 KOMponenten ELEKTROANLAGE 
 ELECTRICAL SYSTEM COMPONENTS





 COMPONENTES INSTALACIÓN ELÉCTRICA 
 COMPOSANTS INSTALLATION ÉLECTRIQUE

POS Codice	Q.tà	 Descrizione	 Description	 Designation	 Benennung	 Descripción
20 1772950019	1 NR	SCATOLA ESCLUSIONE SICUREZZE COMPLETA TTC	BOX EXCLUSION SAFETY TTC	BOÎTE	GEHÄUSE	CAJA
21 1585570006	1 NR	SELETTORE	SELECTOR	SÉLECTEUR	WÄHLSCHALTER	SELECTOR
22 1651290015	1 NR	CHIAVE	KEY	CLÉ	SCHLÜSSEL	LLAVE
23 077706Y1	1 NR	PIASTRA DI SEPARAZIONE	PLATE SEPARATION	PLAQUE DE SÉPARATION	PLATTENTRENNU NG	PLACA DE SEPARACIÓN
24 17707400	1 NR	KIT ELE GENERALE LL2614 T	WIRING KIT LL2614 T	KIT DE CABLAGE LL2614 T	KABELSATZ LL2614 T	KIT DE CABLEADO LL2614T
25 17707600	1 NR	KIT ELE CESTO LL2614 T	WIRING KIT BASKET LL2614 T	KIT DE CABLAGE PANIER LL2614 T	KABELSATZ ARBEITSKORB LL2614 T	KIT DE CABLEADO CESTA LL2614 T
26 1773980004	1 NR	PULSANTE	BUTTON	BOUTON	DRUCKKNOPF	BOTÓN
27 1628400001	1 NR	PULSANTE	BUTTON	BOUTON	DRUCKKNOPF	BOTÓN
28 1730720005	1 NR	SPIA VERDE PARTE AEREA GRANDE	BIG GREEN LIGHT AERIAL PART	VOYANT	KONTROLLLEUC HTE	INDICADOR
29 1556350068	1 NR	SELETTORE A LEVA 3 POSIZIONI	3 POSITION LEVER SWITCH	SÉLECTEUR	WÄHLSCHALTER	SELECTOR
30 1692150001	1 NR	BLOCCHETTO	BLOCK	BLOC	BLOCK	BLOQUE

 COMPONENTI IMPAINTO ELETTRICO

 KOMponenten ELEKTROANLAGE 
 ELECTRICAL SYSTEM COMPONENTS

 COMPONENTES INSTALACIÓN ELÉCTRICA 
 COMPOSANTS INSTALLATION ÉLECTRIQUE

POS Codice	Q.tà	 Descrizione	 Description	 Designation	 Benennung	 Descripción
31 175726002402	1 NR	COPERCHIO SCATOLA STOP A TERRA DIESEL LL2614-X26JP-X7 70AJ	BOX COVER	COUVERCLE BOÎTE	KASTENABDECK UNG	TAPA DE CAJA
31 1770750001	1 NR	SCATOLA STOP A TERRA LITHIUM LL26/X26/X770 LL15/X15/X430 TT COMPLETA DI CABLAGGIO E CONNETTORE	BOX WITH WIRING	BOÎTE AVEC CÂBLAGE	KASTEN MIT VERKABELUNG	CAJA CON CABLEADO
31 1773980003	1 NR	SCATOLA STOP A TERRA DIESEL LL2614-X26JP-X7 70AJ TT COMPLETA DI CABLAGGIO E CONNETTORE	BOX WITH WIRING	BOÎTE AVEC CÂBLAGE	KASTEN MIT VERKABELUNG	CAJA CON CABLEADO
32 04774900	1 NR	STACCA BATTERIA	BATTERY CUT-OFF DEVICE	COUPE BATTERIE	BATTERIETRENN SCHALTER	CORTA-BATERÍA
33 1757250023	1 NR	SPIA STABILIZZATORE LED COMPLETA DI CONNETTORE	LED LIGHT	TEMOIN LED	KONTROLLAMP E	INDICADOR LED





 COMPONENTI IMPAINTO ELETTRICO

 KOMONENTEN ELEKTROANLAGE

 ELECTRICAL SYSTEM COMPONENTS

 COMPONENTES INSTALACIÓN ELÉCTRICA

 COMPOSANTS INSTALLATION ÉLECTRIQUE

POS Codice	Q.tà	 Descrizione	 Description	 Designation	 Benennung	 Descripción
34 1739150023	1 NR	MORSETTO POSITIVO A C PER BATTERIA M10	POSITIVE BATTERY CLAMP "C" M10	BORNE POSITIVE A C POUR BATTERIE M10	POSITIVE KLEMME FÜR BATTERIE M10	BORNE POSITIVO A C PARA BATERÍA M10
35 1739150025	1 NR	MORSETTO NEGATIVO A C PER BATTERIA M10	NEGATIVE BATTERY TERMINAL C M10	BORNE NEGATIVE A C POUR BATTERIE M10	NEGATIVE KLEMME FÜR BATTERIE M10	BORNE NEGATIVO A C PARA BATERÍA M10
36 1739150024	1 NR	COPRIMORSETT O NERO PER MORSETTO MARINO	TERMINAL COVER BLACK FOR MARINE TERMINAL	COUVRE-BORNE NOIR POUR BORNE MARINE	SCHWARZE KLEMMENABDEC KUNG	CUBRE-BORNE NEGRO PARA BORNE MARINO
37 1739150022	1 NR	COPRIMORSETT O ROSSO PER MORSETTO MARINO	TERMINAL COVER RED FOR MARINE TERMINAL	CACHE-BORNE ROUGE POUR BORNE MARINE	ROTE KLEMMENABDEC KUNG	CUBRE-BORNE ROJO PARA BORNE MARINO
38 1772950021	1 NR	CENTRALINA 4 RELE' INDIPENDENTI 12V A TENUTA	CONTROL UNIT 4 RELAY 'INDEPENDENT 12V SEALED	UNITÉ DE CONTRÔLE	STEUERGERÄT	UNIDAD DE CONTROL

 COMPONENTI IMPIANTO ELETTRICO LITIO

KOMPONENTEN ELEKTROANLAGE LITHIUM 

 ELECTRICAL SYSTEM COMPONENTS LITHIUM

COMPONENTES INSTALACIÓN ELÉCTRICA LITHIUM 



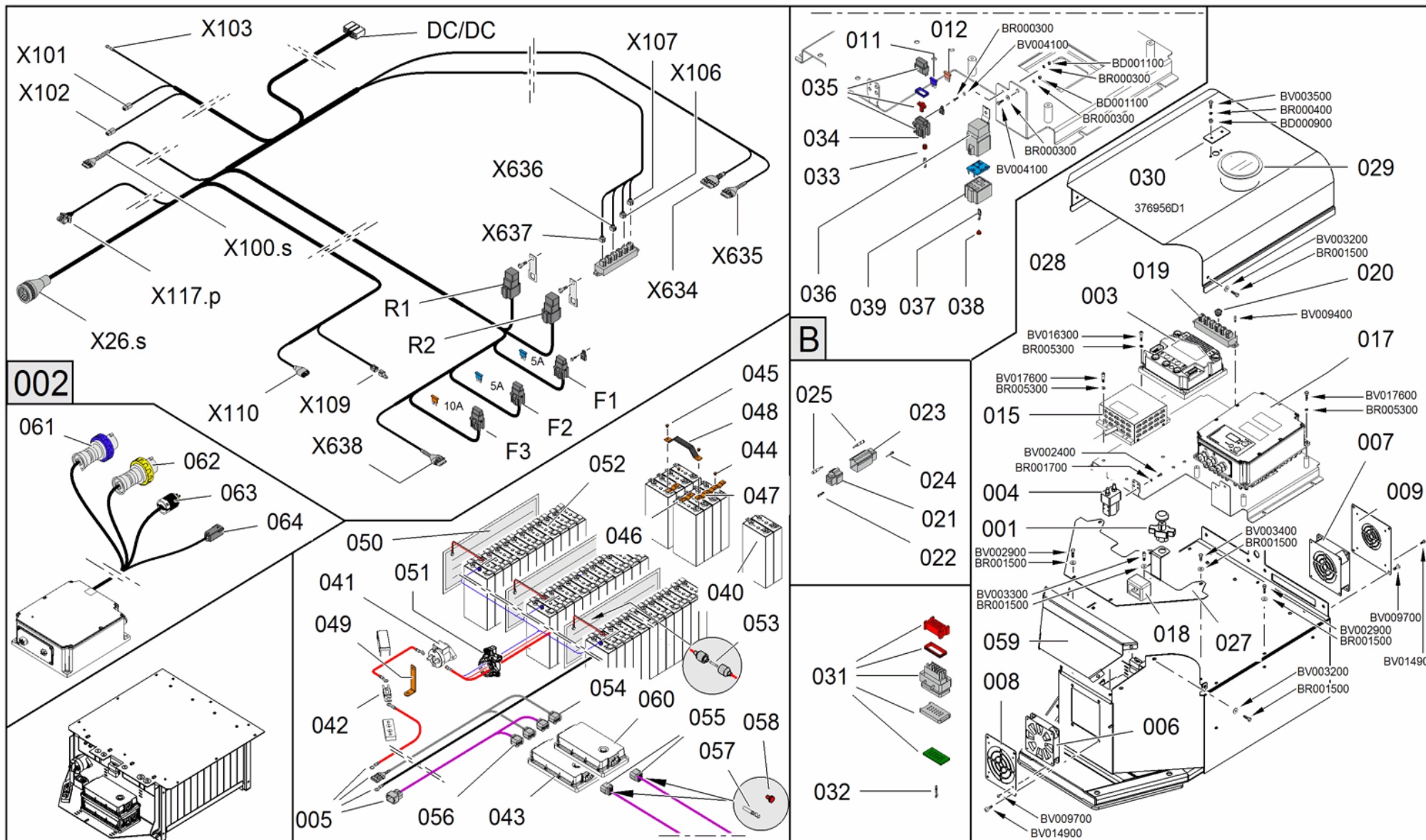

 COMPOSANTS INSTALLATION ÉLECTRIQUE LITHIUM



 COMPONENTI IMPIANTO ELETTRICO LITIO

 KOMponenten ELEKTROANLAGE LITHIUM 
 ELECTRICAL SYSTEM COMPONENTS LITHIUM

 COMPONENTES INSTALACIÓN ELÉCTRICA LITHIUM 
 COMPOSANTS INSTALLATION ÉLECTRIQUE LITHIUM

POS Codice	Q.tà	 Descrizione	 Description	 Designation	 Benennung	 Descripción
1 07827000	1 NR	STACCABATTERI A A FUNGO 150A NOMINALI	BATTERY DISCONNECTER S 150A NOMINAL	COUPE-BATTERI E	BATTERIE-TRENN SCHALTER	DESCONECTADO R DE BATERÍA
2 17707500	1 NR	IMPIANTO ELETTRICO LITHIUM LL2614-X26JP-X7 70AJ T-M	ELECTRICAL SYSTEM LITHIUM LL2614-X26JP X770AJ-T-M	INSTALLATION ÉLECTRIQUE LITHIUM LL2614-X26JP X770AJ-T-M	ELEKTRISCHE ANLAGE LITHIUM LL2614-X26JP X770AJ-T-M	INSTALACIÓN ELÉCTRICA LITHIUM LL2614-X26JP X770AJ-T-M
3 1694760003	1 NR	INVERTER	INVERTER	INVERTER	INVERTER	INVERTER
3 2694760001	1 NR	FUSIBILE	FUSE	FUSIBLE	SICHERUNG	FUSIBLE
4 26429300	1 NR	TELERUTTORE	REMOTE-CONTR OL SWITCH	TÉLÉRUPTEUR	FERNSCHALTER	TELERUPTOR
5 17795200	1 NR	PACCO BATTERIE 76V 100AH MID CON IMPIANTO ELETTRICO	BATTERY 76V 100AH MID WITH ELECTRICAL SYSTEM	PACK BATTERIES 76V 100AH MID AVEC INSTALLATION ÉLECTRIQUE	BATTERIEPAKET 76V 100AH MID MIT ELEKTRISCHER ANLAGE	PAQUETE BATERIAS 76V 100AH MID CON INSTALACIÓN ELÉCTRICA
6 1690690001	1 NR	VENTOLA ANTERIORE	FRONT FAN	VENTILATEUR	LÜFTERRAD	VENTILADOR
7 1690690002	1 NR	VENTOLA POSTERIORE	REAR FAN	VENTILATEUR	LÜFTERRAD	VENTILADOR
8 067808H2	1 NR	TAPPO VENTOLA POSTERIORE	CAP REAR FAN	BOUCHON	VERSCHLUSS	TAPÓN





 COMPONENTI IMPIANTO ELETTRICO LITIO

 KOMponenten ELEKTROANLAGE LITHIUM

 ELECTRICAL SYSTEM COMPONENTS LITHIUM

 COMPONENTES INSTALACIÓN ELÉCTRICA LITHIUM

 COMPOSANTS INSTALLATION ÉLECTRIQUE LITHIUM

POS Codice	Q.tà	 Descrizione	 Description	 Designation	 Benennung	 Descripción
9 075692H2	1 NR	PIASTRA FISSAGGIO VENTOLA	PLATE	PLAQUE	PLATTE	PLACA
11 05760900	1 NR	FUSIBILE 10A	FUSE 10A	FUSIBLE 10A	SICHERUNG 10A	FUSIBLE 10A
12 05760700	2 NR	FUSIBILE A LAMA 5A	FUSE 5A	FUSIBLE 5A	SICHERUNG 5A	FUSIBLE 5A
15 26947900	1 NR	TRASFORMATORE	TRANSFORMER	TRANSFORMATEUR	TRANSFORMATOR	TRANSFORMADOR
17 17604200	1 NR	CARICABATTERIE 80V-240V LITHIUM	LITHIUM BATTERY CHARGER 80V-240V	LITHIUM BATTERIE 80V-240V	BATTERIELADEGERÄT 80V-240V LITHIUM	CARGADOR DE BATERÍA 80V-240V LITIO
18 1730720088	1 NR	ISOLATORE CONNESSIONE MASSA	INSULATOR EARTH CONNECTION	ISOLATEUR	ISOLATOR	AISLADOR
19 1730720087	1 NR	CONNETTORE DERIVAZIONE CAN	JUNCTION CONNECTOR CAN	CONNECTEUR	VERBINDER	CONECTOR
20 1730720086	1 NR	TAPPO CONNETTORE 2 VIE	CONNECTOR PLUG 2 WAY	BOUCHON CONNECTEUR	VERSCHLUSS VERBINDER	TAPA CONECTOR
21 1757250009	1 NR	CONNETTORE PORTA FEMMINE 4 VIE MOLEX 220-110V 20-25A	CONNECTOR	CONNECTEUR	VERBINDER	CONECTOR





 COMPONENTI IMPIANTO ELETTRICO LITIO

 KOMponenten Elektroanlage Lithium

 ELECTRICAL SYSTEM COMPONENTS LITHIUM

 COMPONENTES INSTALACIÓN ELÉCTRICA LITHIUM

 COMPOSANTS INSTALLATION ÉLECTRIQUE LITHIUM

POS Codice	Q.tà	 Descrizione	 Description	 Designation	 Benennung	 Descripcìon
22 1757250011	1 NR	PUNTALINO	FERRULE	EMBOUT	ZWINGE	PUNTERA
23 1757250010	1 NR	CONNETTORE PORTA MASCHI 4 VIE MOLEX 220-110V 20-25A	CONNECTOR	CONNECTEUR	VERBINDER	CONECTOR
24 1757250013	1 NR	PUNTALINO MASCHIO PER CONNETTORE 4 VIE MOLEX 220-110V 20-25A	FERRULE	EMBOUT	ZWINGE	PUNTERA
25 1757250012	4 NR	TAPPO PER CHIUSURA FORI SU CONNETTORE 4 VIE MOLEX 220-110V 20-25A	CAP	BOUCHON	DECKEL	TAPA
25 1757250012	1 NR	TAPPO PER CHIUSURA FORI SU CONNETTORE 4 VIE MOLEX 220-110V 20-25A	CAP	BOUCHON	DECKEL	TAPA
26 176952D1	1 NR	SUPPORTO COMPONENTI CASSONE LITIO LL2614 MID COMPLETO DI SPUGNE E INSERTI	LITIO COMPONENTS SUPPORT LL2614 MID COMPLETE WITH SPONGES	SUPPORT COMPOSANTS ÉLECTRIQUES	HALTERUNG E-TEILE	SOPORTE COMPONENTES ELÉCTRICOS





 COMPONENTI IMPIANTO ELETTRICO LITIO

 KOMponenten ELEKTROANLAGE LITHIUM

 ELECTRICAL SYSTEM COMPONENTS LITHIUM

 COMPONENTES INSTALACIÓN ELÉCTRICA LITHIUM





 COMPOSANTS INSTALLATION ÉLECTRIQUE LITHIUM

POS Codice	Q.tà	 Descrizione	 Description	 Designation	 Benennung	 Descripción
27 176949D1	1 NR	CHIUSURA SUPERIORE VANO CELLE COMPLETA DI SPUGNE E INSERTI	CLOSING UPPER COMPARTMENT CELL FULL OF SPONGE AND INSERTS	PLAQUE DE VERROUILLAGE	ARRETIERPLATT E	PLACA DE BLOQUEO
28 176956D1	1 NR	COPERCHIO CASSONE LITIO LL2614 COMPLETO DI SPUGNE E VETRO	LITHIUM COVER LL2614 WITH SPONGES AND GLASS	COUVERTURE BATTERIES LITHIUM	ABDECKUNG LITHIUM-BATTERI EN	CUBIERTA BATERIAS LITHIUM
29 07377300	1 NR	PROTEZIONE TRASPARENTE LED CARICABATTERIE PACCO LITIO 72V	TRANSPARENT PROTECTION CHARGER LED	PROTECTION TRANSPARENT	TRANSPARENT SCHUTZART	PROTECCIÓN TRANSPARENT
32 16774800	35 NR	PUNTALINO FE05-1 MMQ AMPSEAL STAGNATO GL14.70 BATTERY	TERMINAL	BORNE	KLEMMME	BORNE
33 1757260006	6 NR	PUNTALINO PER PORTAFUSIBILE	FERRULE FOR FUSE HOLDER	BORNE	KLEMMME	BORNE
34 1757260007	6 NR	GOMMINO PER PORTAFUSIBILE	RUBBER FERRULE FOR FUSE HOLDER	INSERT CAOUTCHOUC	GUMMISATZ	INSERCIÓN DE GOMA

 COMPONENTI IMPIANTO ELETTRICO LITIO

 KOMponenten ELEKTROANLAGE LITHIUM 
 ELECTRICAL SYSTEM COMPONENTS LITHIUM





 COMPONENTES INSTALACIÓN ELÉCTRICA LITHIUM 
 COMPOSANTS INSTALLATION ÉLECTRIQUE LITHIUM

POS Codice	Q.tà	 Descrizione	 Description	 Designation	 Benennung	 Descripción
35 1757260001	1 NR	PORTAFUSIBILE	FUSE HOLDER	PORTE-FUSIBLE	SICHERUNGSHAL TER	PORTAFUSIBILE
35 1757260001	3 NR	PORTAFUSIBILE	FUSE HOLDER	PORTE-FUSIBLE	SICHERUNGSHAL TER	PORTAFUSIBILE
36 1776330003	2 NR	RELE' MINI TYCO 12V PER CONNETTORE A TENUTA (MK2 DA C170000893)	RELAY 'MINI 12V TYCO CONNECTOR SEAL (MK2 FROM C170000893)	RELAIS	RELAIS	RELÉ
37 1776330007	8 NR	PUNTALINI PER RELE' A TENUTA MINI TYCO 12V (MK2 DA C170000893)	FERRULE FOR RELAY SEAL MINI 12V TYCO (MK2 FROM C170000893)	BORNE	KLEMMME	BORNE
38 1776330005	8 NR	GOMMINO PER RELE' A TENUTA MINI TYCO 12V (MK2 DA C170000893)	RUBBER FOR RELAY SEAL MINI 12V TYCO (MK2 FROM C170000893)	JOINT RELÉ	GUMMIDICHTUNG	JUNTA DE GOMA
39 1776330004	2 NR	PORTA RELE' A TENUTA PER MINI TYCO 12V (MK2 DA C170000893)	HOLDER RELAY SEAL FOR MINI 12V TYCO (MK2 FROM C170000893)	PORTE RELAIS	RELAISHALTER	PORTARELÉ

 COMPONENTI IMPIANTO ELETTRICO LITIO

 KOMponenten ELEKTROANLAGE LITHIUM 
 ELECTRICAL SYSTEM COMPONENTS LITHIUM





 COMPONENTES INSTALACIÓN ELÉCTRICA LITHIUM 
 COMPOSANTS INSTALLATION ÉLECTRIQUE LITHIUM

POS Codice	Q.tà	 Descrizione	 Description	 Designation	 Benennung	 Descripción
40 2781020001	1 NR	COPPIA DI CELLE LITIO MID COMPLETA A RICAMBIO	COUPLE OF LITHIUM CELLS MID FULL REPLACEMENT	COUPLE DE CELLULES LITHIUM	PAAR VON LITHIUMZELLE	PAR DE CELULAS DE LITIO
41 2781020012	1 NR	TELERUTTORE DI POTENZA INTERNO PACCO MID	RELAY OF INTERNAL POWER PACK MID	TELERUPTEUR	FERNSCHALTER	TELEINTERRUPTOR
42 2781020014	1 NR	FUSIBILE 400A	FUSE 400A	FUSIBLE	SICHERUNG	FUSIBLE
43 2781020017	1 NR	BMS MASTER MID	BMS MASTER MID	BMS MASTER MID	BMS MASTER MID	BMS MASTER MID
44 078574D1	1 NR	CHIUSURA FORI FISSAGGIO PER LAMPEGGIANTE SU PACCO LITIO	CLOSING FIXING HOLES FOR FLASHING ON PACK LITHIUM	FERMETURE	SCHLUSS	CIERRE
44 2781020003	4 NR	RIVETTO RAME H=10	COPPER RIVET H=10	RIVET	NIETE	REMACHE
44 2781020003	1 NR	RIVETTO RAME H=10	COPPER RIVET H=10	RIVET	NIETE	REMACHE
45 2781020004	1 NR	RIVETTO RAME H=12	COPPER RIVET H=12	RIVET	NIETE	REMACHE
45 2781020004	4 NR	RIVETTO RAME H=12	COPPER RIVET H=12	RIVET	NIETE	REMACHE
46 2781020005	1 NR	LAMA FISSAGGIO CELLE 2 FORI	PLATE FIXING CELLS 2 HOLES	PLAQUE DE FIXATION	MONTAGEPLATTE	PLACA DE FIJACION

 COMPONENTI IMPIANTO ELETTRICO LITIO

 KOMponenten ELEKTROANLAGE LITHIUM 
 ELECTRICAL SYSTEM COMPONENTS LITHIUM





 COMPONENTES INSTALACIÓN ELÉCTRICA LITHIUM 
 COMPOSANTS INSTALLATION ÉLECTRIQUE LITHIUM

POS Codice	Q.tà	 Descrizione	 Description	 Designation	 Benennung	 Descripción
47 2781020006	1 NR	LAMA FISSAGGIO CELLE 4 FORI	PLATE FIXING CELLS 4 HOLES	PLAQUE DE FIXATION	MONTAGEPLATT E	PLACA DE FIJACION
48 2781020007	1 NR	LAMA DI COLLEGAMENTO TRA MODULI	PLATE CONNECTION BETWEEN MODULES	PLAQUE DE CONEXION	VERBINDUNGSPL ATTE	PLACA DE CONEXIÓN
49 2781020008	1 NR	LAMA COLLEGAMENTO TELERUTTORE	PLATE CONNECTION RELAY	PLACA DE CONEXIÓN	VERBINDUNGSPL ATTE	PLACA DE CONEXIÓN
50 2781020010	1 NR	HEATER 76V 100W	HEATER 76V 100W	CHAUFFE 76V 100W	HEIZUNG 76V 100W	CALENTADOR 76V 100W
51 2781020011	1 NR	SENSORE LEM PER LITIO MID	LEM SENSOR FOR LITHIUM MID	CAPTEUR	SENSOR	SENSOR
52 2781020013	1 NR	SENSORE TEMPERATURA PACCO LITIO MID	TEMPERATURE SENSOR PACK LITHIUM MID	CAPTEUR	SENSOR	SENSOR
53 2781020015	1 NR	FUSIBILE IN VETRO 5X20.4 1A	FUSE GLASS 5X20.4 1A	FUSIBLE	SICHERUNG	FUSIBLE
54 2781020021	1 NR	CONNETTORE BMS 26 VIE	CONNECTOR BMS 26 WAYS	CONNECTEUR	VERBINDER	CONECTOR
55 2781020020	1 NR	CONNETTORE BMS 34 VIE FASATURA 2	CONNECTOR BMS 34 WAYS STEP 2	CONNECTEUR	VERBINDER	CONECTOR

 COMPONENTI IMPIANTO ELETTRICO LITIO

 KOMponenten ELEKTROANLAGE LITHIUM 
 ELECTRICAL SYSTEM COMPONENTS LITHIUM

 COMPONENTES INSTALACIÓN ELÉCTRICA LITHIUM 
 COMPOSANTS INSTALLATION ÉLECTRIQUE LITHIUM

POS Codice	Q.tà	 Descrizione	 Description	 Designation	 Benennung	 Descripción
56 2781020019	1 NR	CONNETTORE BMS 34 VIE FASATURA 1	CONNECTOR BMS 34 WAYS STEP 1	CONNECTEUR	VERBINDER	CONECTOR
57 2781020022	1 NR	PIN PER CONNETTORI BMS 0,75-1,25	PIN CONNECTORS FOR BMS 0.75-1.25	BROCHE POUR CONNECTEURS	PIN-ANSCHLÜSS E	PIN PARA CONECTORES
58 2781020023	1 NR	TAPPO PER CONNETTORI BMS	CAP FOR CONNECTORS BMS	COUVERCLE	DECKEL	TAPA
59 176957D1	1 NR	CHIUSURA SUPERIORE CASSONE LITIO LL2614 COMPLETA DI INSERTI	UPPER CLOSURE LL2614 LITHIUM COMPLETE WITH INSERTS	PLAQUE DE VERROUILLAGE SUPÉRIEURE	OBERE ARRETIERPLATT E	PLACA DE BLOQUEO SUPERIOR
60 2781020018	1 NR	BMS SLAVE MID	BMS SLAVE MID	BMS SLAVE MID	BMS SLAVE MID	BMS SLAVE MID

 TELECOMANDO

FERNSTEUERUNG 

 REMOTE CONTROL

TELECOMANDO 



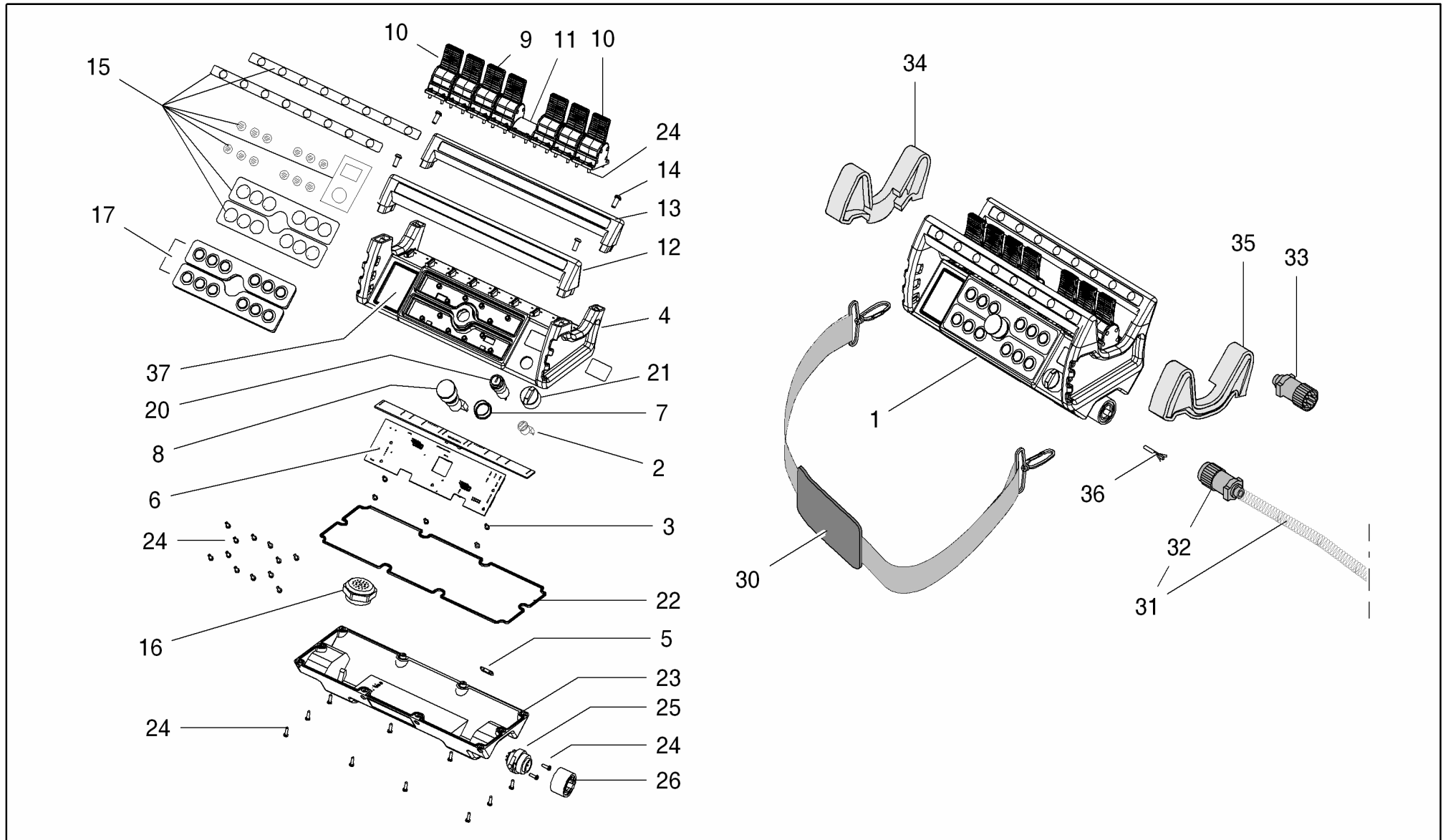

 TÉLÉCOMMANDE



 TELECOMANDO

 FERNSTEUERUNG 
 REMOTE CONTROL





 TELECOMANDO 
 TÉLÉCOMMANDE

POS Codice	Q.tà	 Descrizione	 Description	 Designation	 Benennung	 Descripcìon
1 27237400	1 NR	TELECOMANDO CASE GRIGIO	REMOTE CONTROL GREY CASE	TÉLÉCOMMANDE	FERNSTEUERUN G	TELECOMANDO
2 07359400	1 NR	CONTATTO PER STOP EMERGENZA TELECOMANDO 3S	CONTACT FOR EMERGENCY STOP REMOTE CONTROL 3S	CONTACTE POUR ARRET D'URGENCE	KONTAKT FÜR NOTSTOP	CONTACTO PARA PARADA DE EMERGENCIA
3 2646170003	5 NR	VITI SCHEDA ELETTRONICA	ELECTRONIC BOARD SCREWS	VIS	SCHRAUBEN	TORNILLOS

 TELECOMANDO

 FERNSTEUERUNG 
 REMOTE CONTROL





 TELECOMANDO 
 TÉLÉCOMMANDE

POS Codice	Q.tà	 Descrizione	 Description	 Designation	 Benennung	 Descripcìon
4 2723740001	1 NR	COPERCHIO SUPERIORE TELECOMANDO CASE GRIGIO + DISPLAY E PULSANTI (PER RICAMBIO È NECESSARIO IL SN DEL TELECOMANDO)	TOP COVER REMOTE CONTROL CASE GREY + DISPLAY AND BUTTONS (AS SPARE IS COMPULSORY THE SN OF REMOTE CONTROL)	COUVERCLE	DECKEL	TAPA
4 2723740002	1 NR	COPERCHIO SUPERIORE TELECOMANDO CASE GRIGIO SOLO COPERCHIO, SENZA COMPONENTI E SENZA DISPLAY	TOP COVER REMOTE CONTROL CASE GREY ONLY CASE, WITHOUT COMPONENTS AND DISPLAY	COUVERCLE	DECKEL	TAPA
5 07359500	1 NR	CONTATTO REED INTERNO TELECOMANDO 3S	REED CONTACT INTERNAL REMOTE 3S	REED CONTACT INTÉRIEUR 3S DISTANCE	REEDKONTAKT INDOOR REMOTE 3S	CONTACTO REED 3S REMOTO DE INTERIOR
6 2646170002	1 NR	SCHEDA ELETTRONICA PER TELECOMANDO	ELECTRONIC BOARD FOR REMOTE CONTROL	FICHE ÉLECTRIQUE	ELEKTRONISCHE PLATINE	PLACA ELECTRÓNICA
7 2646170007	1 NR	ANELLO	RING	BAGUE	RING	ANILLO

 TELECOMANDO

 FERNSTEUERUNG 
 REMOTE CONTROL





 TELECOMANDO 
 TÉLÉCOMMANDE

POS Codice	Q.tà	 Descrizione	 Description	 Designation	 Benennung	 Descripción
8 2646170008	1 NR	PULSANTE EMERGENZA	EMERGENCY BUTTON	BOUTON D'URGENCE	NOTSTOP KNOPF	PULSADOR DE EMERGENCIA
9 17550700	1 NR	KIT PROTEZIONE IN GOMMA PER JOYSTICK NERA	PROTECTION KIT	PROTECTION KIT	GUMMISCHUTZ KIT	PROTECCIÓN DE GOMA
9 2646170009	6 NR	LEVA NERA	LEVER BLACK	LEVIER	HEBEL	PALANCA
10 17550800	1 NR	KIT PROTEZIONE IN GOMMA PER JOYSTICK ROSSA	PROTECTION	PROTECTION	GUMMISCHUTZ	PROTECCION DE GOMA
10 2646170010	2 NR	LEVA ROSSA	LEVER RED	LEVIER	HEBEL	PALANCA
12 2646170013	1 NR	IMPUGNATURA INFERIORE	GRIP LOWER PART	POIGNÉE	GRIFF	EMPUÑADURA
13 2646170012	1 NR	IMPUGNATURA SUPERIORE	GRIP UPPER PART	POIGNÉE	GRIFF	EMPUÑADURA
14 2646170014	4 NR	VITE	SCREW	VIS	SCHRAUBE	TORNILLO
15 27005200	1 NR	KIT ADESIVI	DECALS KIT	KIT AUTOCOLLANTS	KLEBERSATZ	KIT PEGATINAS
16 2646170027	1 NR	CICALINO COMPLETO DI SCHEDA ELETTRONICA TELECOMANDO	BEEPER FOR REMOTE CONTROL	BUZZER	SUMMER	ZUMBADOR COMPLETO DE TARJETA ELECTRÓNICA TELEMANDO
17 2646170017	1 NR	PULSANTI	BUTTONS	BOUTONS	DRUCKKNÖPFE	BOTONES

 TELECOMANDO

 FERNSTEUERUNG 
 REMOTE CONTROL





 TELECOMANDO 
 TÉLÉCOMMANDE

POS Codice	Q.tà	 Descrizione	 Description	 Designation	 Benennung	 Descripció
20 2683930001	1 NR	INTERRUTTORE	SWITCH	INTERRUPTEUR	SCHALTER	INTERRUPTOR
21 2683930002	1 NR	CHIAVE ACCENSIONE	IGNITION KEY	CLÉ DE DÉMARRAGE	ZÜNDSCHLÜSSE L	LLAVE DE ENCENDIDO
22 2646170022	1 NR	GUARNIZIONE	GASKET	JOINT	DICHTUNG	GUARNICIÓN
23 2646170023	1 NR	COPERCHIO INFERIORE	COVER LOWER PART	COUVERCLE	DECKEL	TAPA
24 2646170024	56 NR	VITE	SCREW	VIS	SCHRAUBE	TORNILLO
25 2646170025	1 NR	CONNETTORE	CONNECTOR	CONNECTEUR	VERBINGER	CONECTOR
26 2646170026	1 NR	COPERCHIO CONNETTORE	COVER CONNECTOR	COUVERCLE	DECKEL	TAPA
30 2646170030	1 NR	CINGHIA	BELT	COURROIE	RIEMEN	CORREA
31 17235800	1 NR	CAVO TELECOMANDO COMPLETO IIIS /200	COMPLETE REMOTE CONTROL CABLE IIIS /200	CÂBLE COMPLET TÉLÉCOMMANDE IIIS /200	FERNBEDIENUNG SKABEL KOMPLETT IIIS /200	CABLE TELECOMANDO COMPLETO IIIS /200
32 2646170032	1 NR	CONNETTORE COLLEGAMENTO TELECOMANDO	CONNECTOR FOR REMOTE CONTROL	CONNECTEUR	VERBINGER	CONECTOR
33 1684540001	1 NR	DISPOSITIVO DI COMANDO PER ABILITAZIONE EMERGENZA A TERRA	CONTROL DEVICE FOR ACTIVATING THE EMERGENCY GROUND	DISPOSITIF DE COMMANDE EN CAS D'URGENCE	STEUERVORRICH TUNG IM NOTFALL	DISPOSITIVO DE CONTROL DE EMERGENCIA

 TELECOMANDO

 FERNSTEUERUNG 
 REMOTE CONTROL

 TELECOMANDO 
 TÉLÉCOMMANDE

POS Codice	Q.tà	 Descrizione	 Description	 Designation	 Benennung	 Descripción
34 07027200	1 NR	PROTEZIONE SINISTRA	LEFT PROTECTION	PROTECTION GAUCHE	ABDECKUNG LINKS	PROTECCIÓN IZQUIERDA
35 07027100	1 NR	PROTEZIONE DESTRA	RIGHT PROTECTION	PROTECTION DROITS	ABDECKUNG RECHTS	PROTECCIÓN DERECHA
36 27283000	1 NR	PUNTALINO FEMMINA PER CONNETTORE TELECOMANDO	TERMINAL FEMALE CONNECTOR FOR REMOTE CONTROL	CONNECTEUR FEMELLE	VERBINDUNG	CONECTOR
36 2728300001	1 NR	PUNTALINO MASCHIO PER CONNETTORE TELECOMANDO	TERMINAL MALE CONNECTOR FOR REMOTE CONTROL	CONNECTEUR	VERBINDER	CONECTOR
37 07320200	1 NR	SCHERMO LCD (PER RICAMBIO È NECESSARIO IL SN DEL TELECOMANDO)	DISPLAY (AS SPARE IS COMPULSORY THE SN OF REMOTE CONTROL)	ÉCRAN	DISPLAY	PANTALLA

 IMPIANTO ELETTRICO

ELEKTRISCHE ANLAGE 

 ELECTRICAL SYSTEM

INSTALACIÓN ELÉCTRICA 



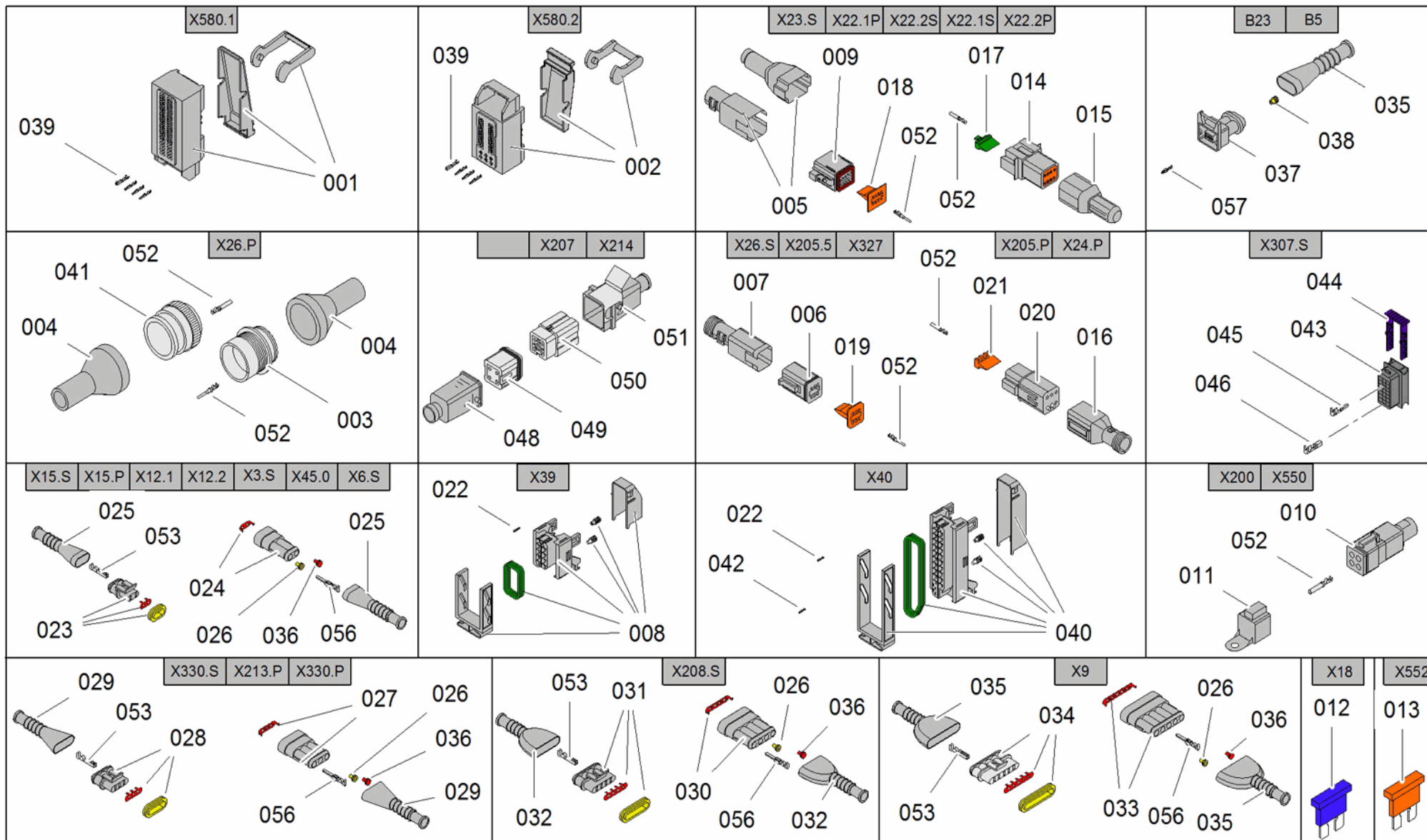

 INSTALLATION ÉLECTRIQUE



 IMPIANTO ELETTRICO

 ELEKTRISCHE ANLAGE 
 ELECTRICAL SYSTEM





 INSTALACIÓN ELÉCTRICA 
 INSTALLATION ÉLECTRIQUE

POS Codice	Q.tà	 Descrizione	 Description	 Designation	 Benennung	 Descripción
4 1730720054	1 NR	CAPPUCCIO POSTERIORE	CAP	CAPUCHON	KAPPE	CAPUCHO
5 1730720035	1 NR	COVER POSTERIORE RIGIDA PER CONNETTORE 8 VIE MASCHIO	PROTECTION	PROTECTION	SCHUTZ	PROTECCION
5 1757250025	1 NR	CAPPUCCIO POSTERIORE PER CONNETTORE MASCHIO	CAP	CAPUCHON	KAPPE	TAPA
6 1730720037	1 NR	CONNETTORE 6 VIE MASCHIO	6-WAY MALE CONNECTOR	CONNECTEUR 6 VOIES MÂLE	6-WEGE-VERBIN DER	CONECTOR 6 VÍAS
7 1730720039	1 NR	COVER POSTERIORE RIGIDA PER CONNETTORE 6 VIE MASCHIO	PROTECTION	PROTECTION	SCHUTZ	PROTECCION
9 1730720033	1 NR	CONNETTORE 8 VIE MASCHIO	8-WAY MALE CONNECTOR	CONNECTEUR 8 VOIES MÂLE	8-WEGE-VERBIN DER STIFT	CONECTOR 8 VÍAS MACHO
10 1763330001	1 NR	CONNETTORE 4 VIE MASCHIO DEUTSCH	4-WAY MALE CONNECTOR DEUTSCH	CONNECTEUR 4 VOIES MÂLE DEUTSCH	4-WEGE-VERBIN DER STIFT DEUTSCH	CONECTOR 4 VÍAS MACHO DEUTSCH

 IMPIANTO ELETTRICO

 ELEKTRISCHE ANLAGE 
 ELECTRICAL SYSTEM





 INSTALACIÓN ELÉCTRICA 
 INSTALLATION ÉLECTRIQUE

POS Codice	Q.tà	 Descrizione	 Description	 Designation	 Benennung	 Descripción
11 1763330002	1 NR	CAPPUCCIO FRONTALE CONNETTORE 4 VIE MASCHIO DEUTSCH	CAP FOR 4-WAY MALE CONNECTOR DEUTSCH	PAC CONNECTEUR 4 VOIES MÂLE DEUTSCH	CAP 4-WEGE-VERBIN DER STIFT DEUTSCH	CAP CONECTOR 4 VÍAS MACHO DEUTSCH
12 07700700	1 NR	FUSIBILE A LAMA 25A	FUSE 25A	FUSIBLE 25A	SICHERUNG 25A	FUSIBLE 25A
13 05760700	1 NR	FUSIBILE A LAMA 5A	FUSE 5A	FUSIBLE 5A	SICHERUNG 5A	FUSIBLE 5A
14 1730720029	1 NR	CONNETTORE 8 VIE FEMMINA	8-WAY FEMALE CONNECTOR	CONNECTEUR 8 VOIES FEMELLE	8-WEGE-VERBIN DER BUCHSE	CONECTOR 8 VÍAS HEMBRA
15 1730720031	1 NR	COVER POSTERIORE RIGIDA PER CONNETTORE 8 VIE FEMMINA	PROTECTION	PROTECTION	SCHUTZ	PROTECCION
15 1757250026	1 NR	CAPPUCCIO POSTERIORE PER CONNETTORE FEMMINA	CAP	CAPUCHON	KAPPE	TAPA

 IMPIANTO ELETTRICO

 ELEKTRISCHE ANLAGE 
 ELECTRICAL SYSTEM





 INSTALACIÓN ELÉCTRICA 
 INSTALLATION ÉLECTRIQUE

POS Codice	Q.tà	 Descrizione	 Description	 Designation	 Benennung	 Descripción
16 1730720084	1 NR	COVER POSTERIORE RIGIDA PER CONNETTORE 6 VIE FEMMINA	PROTECTION	PROTECTION	SCHUTZ	PROTECCION
16 1757250027	1 NR	CAPPUCCIO POSTERIORE PER CONNETTORE 6 VIE FEMMINA	CAP	CAPUCHON	KAPPE	TAPA
17 1730720030	1 NR	PIASTRINA DI BLOCCAGGIO CONNETTORE 8 VIE FEMMINA	PLATE	PLAQUE	PLATTE	PLACA
18 1730720034	1 NR	PIASTRINA DI BLOCCAGGIO CONNETTORE 8 VIE MASCHIO	PLATE	PLAQUE	PLATTE	PLACA
19 1730720038	1 NR	PIASTRINA DI BLOCCAGGIO CONNETTORE 6 VIE MASCHIO	PLATE	PLAQUE	PLATTE	PLACA
20 1730720041	1 NR	CONNETTORE 6 VIE FEMMINA	6-WAY FEMALE CONNECTOR	CONNECTEUR 6 VOIES FEMELLE	6-WEGE-VERBIN DER BUCHSE	CONECTOR 6 VÍAS HEMBRA

 IMPIANTO ELETTRICO

 ELEKTRISCHE ANLAGE 
 ELECTRICAL SYSTEM





 INSTALACIÓN ELÉCTRICA 
 INSTALLATION ÉLECTRIQUE

POS Codice	Q.tà	 Descrizione	 Description	 Designation	 Benennung	 Descripcìon
21 1730720042	1 NR	PIASTRA BLOCCAGGIO CONNETTORE 6 VIE FEMMINA	CONNECTOR	CONNECTEUR	VERBINDER	CONECTADOR
23 1757250031	1 NR	CONNETTORE SUPERSEAL PF 2 VIE	CONNECTOR	CONNECTEUR	VERBINDER	CONECTADOR
24 1757250032	1 NR	CONNETTORE SUPERSEAL PM 2 VIE	CONNECTOR	CONNECTEUR	VERBINDER	CONECTADOR
25 1757250033	1 NR	CAPPUCCIO POSTERIOERE CONNETTORE SUPERSEAL 2 VIE	CAP	CAPUCHON	KAPPE	CAPUCHO
26 1757250043	3 NR	GOMMINO TENUTA PER CAVI CONNETTORI SUPERSEAL	RUBBER SEAL	JOINT EN CAOUTCHOUC	GUMMIDICHTUNG	JUNTA DE GOMA
26 1757250043	1 NR	GOMMINO TENUTA PER CAVI CONNETTORI SUPERSEAL	RUBBER SEAL	JOINT EN CAOUTCHOUC	GUMMIDICHTUNG	JUNTA DE GOMA





 IMPIANTO ELETTRICO

 ELEKTRISCHE ANLAGE 
 ELECTRICAL SYSTEM





 INSTALACIÓN ELÉCTRICA 
 INSTALLATION ÉLECTRIQUE

POS Codice	Q.tà	 Descrizione	 Description	 Designation	 Benennung	 Descripción
27 1757250035	1 NR	CONNETTORE SUPERSEAL PM 3 VIE	CONNECTOR	CONNECTEUR	VERBINDER	CONECTADOR
28 1757250034	1 NR	CONNETTORE SUPERSEAL PF 3 VIE	CONNECTOR	CONNECTEUR	VERBINDER	CONECTADOR
29 1757250036	1 NR	CAPPUCCIO POSTERIOERE CONNETTORE SUPERSEAL 3 VIE	CAP	CAPUCHON	KAPPE	CAPUCHO
30 1757250038	1 NR	CONNETTORE SUPERSEAL PM 4 VIE	CONNECTOR	CONNECTEUR	VERBINDER	CONECTADOR
31 1757250037	1 NR	CONNETTORE SUPERSEAL PF 4 VIE	CONNECTOR	CONNECTEUR	VERBINDER	CONECTADOR
32 1757250039	1 NR	CAPPUCCIO POSTERIORE CONNETTORE SUPERSEAL 4 VIE	CAP	CAPUCHON	KAPPE	CAPUCHO
33 1757250041	1 NR	CONNETTORE SUPERSEAL PM 5 VIE	CONNECTOR	CONNECTEUR	VERBINDER	CONECTADOR





 IMPIANTO ELETTRICO
ELEKTRISCHE ANLAGE 
 ELECTRICAL SYSTEM
INSTALACIÓN ELÉCTRICA 
 INSTALLATION ÉLECTRIQUE

POS Codice	Q.tà	 Descrizione	 Description	 Designation	 Benennung	 Descripción
34 1757250040	1 NR	CONNETTORE SUPERSEAL PF 5 VIE	CONNECTOR	CONNECTEUR	VERBINDER	CONECTADOR
34 1757250056	1 NR	CONNETTORE SUPERSEAL PF 6 VIE	CONNECTOR	CONNECTEUR	VERBINDER	CONECTADOR
35 1757250042	1 NR	CAPPUCCIO POSTERIOERE CONNETTORE SUPERSEAL 5-6 VIE	CAP	CAPUCHON	KAPPE	CAPUCHO
36 1757250046	1 NR	GOMMINO TENUTA TAPPO PER CONNETTORI SUPERSEAL	RUBBER SEAL	JOINT EN CAOUTCHOUC	GUMMIDICHTUNG	JUNTA DE GOMA
37 1757250044	1 NR	CONNETTORE JPT 2 VIE PER ELETTRIVALVOL E	CONNECTOR	CONNECTEUR	VERBINDER	CONECTADOR
38 1757250045	1 NR	GOMMINO TENUTA PER CAVI CONNETTORI JPT	RUBBER SEAL	JOINT EN CAOUTCHOUC	GUMMIDICHTUNG	JUNTA DE GOMA
41 1730720059	1 NR	CONNETTORE 29 VIE F MOTORE (X26)	CONNECTOR	CONNECTEUR	VERBINDER	CONECTADOR

 IMPIANTO ELETTRICO
ELEKTRISCHE ANLAGE 
 ELECTRICAL SYSTEM
INSTALACIÓN ELÉCTRICA 
 INSTALLATION ÉLECTRIQUE

POS Codice	Q.tà	 Descrizione	 Description	 Designation	 Benennung	 Descripción
43 17473600	1 NR	PARTE DI CONNETTORE 24VIE	CONNECTOR PART 24 WAY	CONNECTEUR	VERBINGER	CONECTADOR
44 17473700	1 NR	SLITTA PER CONNETTORE 24 VIE	SLIDE FOR 24-WAY CONNECTOR	COULISSEAU	SCHLITTEN	CORREDERA
48 07913100	2 NR	CONNETTORE COMPLETO PF 3 VIE SOURIAU 220V	COMPLETE CONNECTOR PF 220V 3 WAYS SOURIAU	COMPLET CONNECTEUR À TROIS VOIES PF SOURIAU 220 V	KOMPLETTER 3-WEGE-ANSCHL USS PF SOURIAU 220 V	CONECTOR COMPLETO PF 3 VÍAS SOURIAU 220 V
49 07913200	2 NR	CONNETTORE COMPLETO PM 3 VIE SOURIAU 220V	COMPLETE CONNECTOR PM 220V 3 WAYS SOURIAU	COMPLET CONNECTEUR À TROIS VOIES PM SOURIAU 220 V	KOMPLETTER 3-WEGE-ANSCHL USS PM SOURIAU 220 V	CONECTOR COMPLETO PM 3 VÍAS SOURIAU 220 V
50 07913300	6 NR	TERMINALE M X SEZIONE 1,5 PER CONNETTORE 3 VIE SOURIAU 220V	FERRULE M X SECTION 1.5 FOR CONNECTOR 3 VIE SOURIAU 220V	FERRULE M POUR SECTION 1.5 POUR CONNECTEUR 3 VOIES SOURIAU 220V	M FERRULE FÜR 1.5 ABSCHNITT FÜR 3-WEGE VERBINDER SOURIAU 220V	FÉRULA M PARA SECCIÓN 1,5 PARA CONECTOR 3 VIAS SOURIAU 220V
50 07913400	6 NR	TERMINALE M X SEZIONE 2,5 PER CONNETTORE 3 VIE SOURIAU 220V	FERRULE M X SECTION 2.5 FOR CONNECTOR 3 VIE SOURIAU 220V	FERRULE M POUR SECTION 2.5 POUR CONNECTEUR 3 VOIES SOURIAU 220V	M FERRULE FÜR 2.5 ABSCHNITT FÜR 3-WEGE VERBINDER SOURIAU 220V	FÉRULA M PARA SECCIÓN 2,5 PARA CONECTOR 3 VIAS SOURIAU 220V

 IMPIANTO ELETTRICO
ELEKTRISCHE ANLAGE 
 ELECTRICAL SYSTEM
INSTALACIÓN ELÉCTRICA 
 INSTALLATION ÉLECTRIQUE

POS Codice	Q.tà	 Descrizione	 Description	 Designation	 Benennung	 Descripción
51 07913500	6 NR	TERMINALE F X SEZIONE 1,5 PER CONNETTORE 3 VIE SOURIAU 220V	FERRULE F X SECTION 1.5 FOR CONNECTOR 3 VIE SOURIAU 220V	FERRULE F POUR SECTION 1.5 POUR CONNECTEUR 3 VOIES SOURIAU 220V	F FERRULE FÜR 1.5 ABSCHNITT FÜR 3-WEGE VERBINDER SOURIAU 220V	FÉRULA F PARA SECCIÓN 1,5 PARA CONECTOR 3 VIAS SOURIAU 220V
51 07913600	6 NR	TERMINALE F X SEZIONE 2,5 PER CONNETTORE 3 VIE SOURIAU 220V	FERRULE F X SECTION 2.5 FOR CONNECTOR 3 VIE SOURIAU 220V	FERRULE F POUR SECTION 2.5 POUR CONNECTEUR 3 VOIES SOURIAU 220V	F FERRULE FÜR 2.5 ABSCHNITT FÜR 3-WEGE VERBINDER SOURIAU 220V	FÉRULA F PARA SECCIÓN 2,5 PARA CONECTOR 3 VIAS SOURIAU 220V
56 1757250049	3 NR	PUNTALINO MASCHIO PER SUPERSEAL	FERRULE MALE FOR SUPERSEAL	FERRULE	NUTMUTTER	ANILLO

 IMPIANTO ELETTRICO DIESEL

ELEKTRISCHE ANLAGE DIESEL 



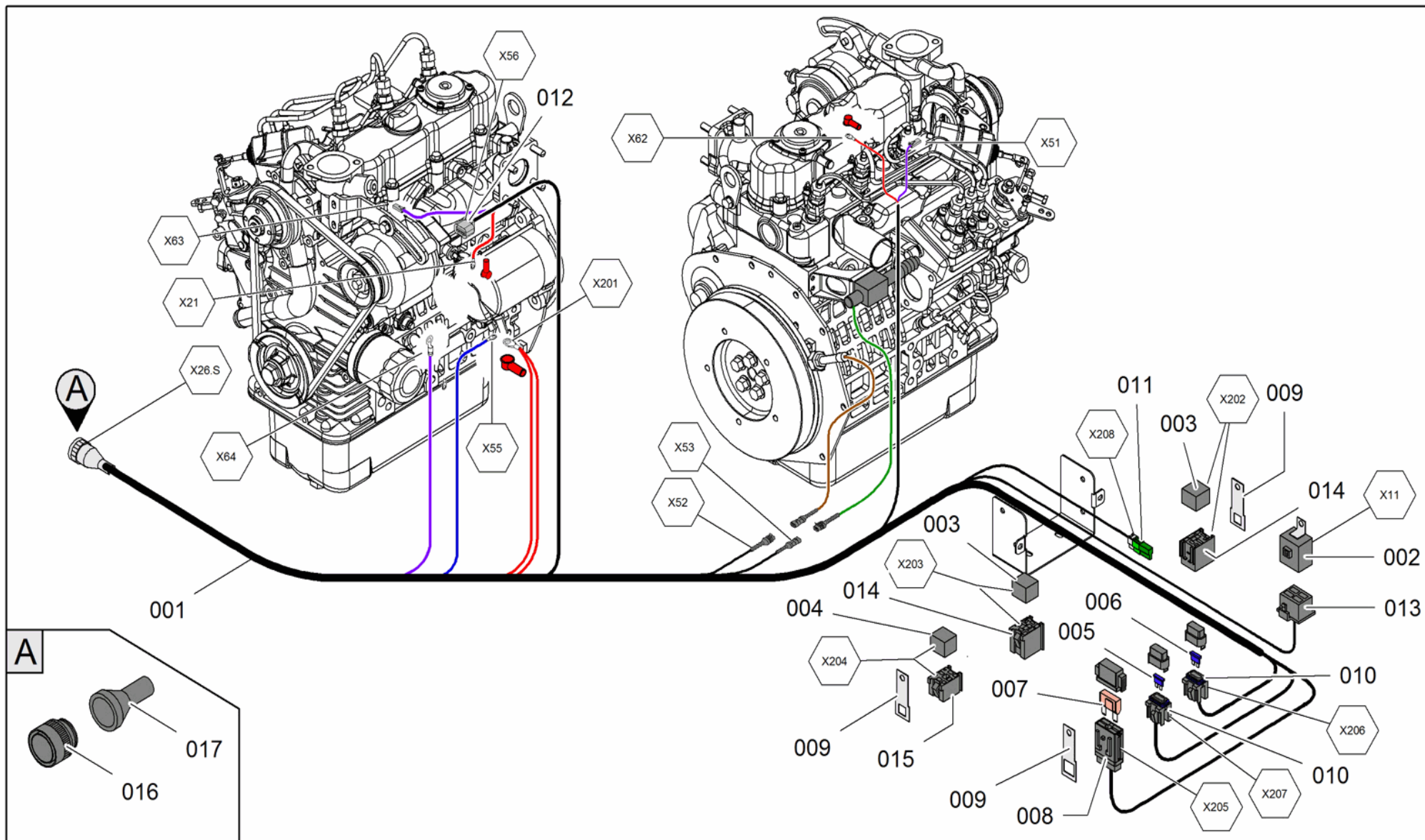

 ELECTRICAL SYSTEM DIESEL

INSTALACIÓN ELÉCTRICA DIESEL 

 INSTALLATION ÉLECTRIQUE DIESEL







 IMPIANTO ELETTRICO DIESEL
ELEKTRISCHE ANLAGE DIESEL 
 ELECTRICAL SYSTEM DIESEL
INSTALACIÓN ELÉCTRICA DIESEL 
 INSTALLATION ÉLECTRIQUE DIESEL

POS Codice	Q.tà	 Descrizione	 Description	 Designation	 Benennung	 Descripción
1 17739800	1 NR	KIT ELE INTEGRAZIONE MOTORE DIESEL LL2614 T	INTEGRATION WIRING KIT DIESEL ENGINE LL2614 T	KIT INTEGRATION DE CABLAGE MOTEUR DIESEL LL2614 T	KABELINTEGRATI ONSSATZ DIESELMOTOR LL2614 T	KIT INTEGRACION DE CABLEADO MOTOR DIESEL LL2614 T
2 2734250015	1 NR	TIMER SPEGNIMENTO PER MOTORE Z602 D902	TIMER ENGINE STOP Z602 D902	TEMPORISATEUR POUR MOTEUR Z602 D902	TIMER FÜR MOTOR Z602 D902	TEMPORIZADOR PARA MOTOR Z602 D902
3 1733730003	1 NR	RELE' CANDELETTE E STOP MOTORE	RELAY 'GLOW AND STOP ENGINE	RELAIS PETITE BOUGIE ET ARRÊT MOTEUR	RELAIS ZÜNDKERZEN UND MOTOR-STOPP	RELÉ BUJÍAS PEQUEÑAS Y STOP MOTOR
4 1739150056	1 NR	RELE' PER MONTAGGIO INTERNO SCATOLA 12V CON DIODO AVVIAMENTO MOTORE	RELAY 'FOR INTERNAL MOUNTING BOX WITH DIODE 12V STARTER MOTOR	RELAIS POUR MONTAGE INTÉRIEUR BOÎTIER 12V AVEC DIODE DÉMARRAGE MOTEUR	RELAIS	RELÉ PARA MONTAJE INTERNO CAJA 12V CON DIODO ARRANQUE MOTOR
5 05760900	1 NR	FUSIBILE 10A	FUSE 10A	FUSIBLE 10A	SICHERUNGT 10A	FUSIBLE 10A
6 05761000	1 NR	FUSIBILE A LAMA 15A	FUSE 15A	FUSIBLE 15A	SICHERUNGSDR AHT 15A	FUSIBLE 15A
7 1739150058	1 NR	FUSIBILE A LAMA DA 50A	FUSE BLADE 50A	FUSIBLE À LAME 50A	50 A SICHERUNG	FUSIBILE A LAMA 50A

 IMPIANTO ELETTRICO DIESEL

 ELEKTRISCHE ANLAGE DIESEL 
 ELECTRICAL SYSTEM DIESEL

 INSTALACIÓN ELÉCTRICA DIESEL 
 INSTALLATION ÉLECTRIQUE DIESEL

POS Codice	Q.tà	 Descrizione	 Description	 Designation	 Benennung	 Descripción
8 1733730031	1 NR	PORTAFUSIBILE MAXI COMPLETO	COMPLETE MAXI FUSE HOLDER	PORTE-FUSIBLES MAXI COMPLET	SICHERUNGSHAL TER KOMPLETT (XE0804611+XE0 804621+ XE0804622)	PORTAFUSIBILE MAXI COMPLETO
9 05434500	1 NR	STAFFA PER SUPPORTO RELE'	BRACKET SUPPORT RELAY	BRIDE	BÜGEL	BRIDA
11 1757260002	1 NR	TAPPO CONNETTORE YAZAKI 2 VIE CON DIODO 2.5A	PLUG	BOUCHON	DECKEL	TAPA
12 1733730010	1 NR	CONNETTORE PORTA FEMMINE 3 VIE ALTERNATORE	CONNECTOR 3 WAY FEMALE HOLDER, ALTERNATOR	CONNECTEUR PORTE FEMELLES 3 VOIES ALTERNATEUR	3-WEGE-VERBIN DER	CONECTOR PORTA HEMBRAS 3 VÍAS ALTERNADOR
13 1733730008	1 NR	CONNETTORE PORTA FEMMINE 4 VIE X11	CONNECTOR WITH FEMALE TERMINAL 4 VIE X11	CONNECTEUR AVEC PORTE FEMELLE 4 VOIES X11	4-WEGE VERBINDER	CONECTOR PORTA HEMBRAS 4 VÍAS X11
14 1757260003	1 NR	PORTA RELE' DI POTENZA 70A	RELAY HOLDER	PORTE-RELAIS	RELAISHALTER	PORTARELÉ
15 1757260004	1 NR	PORTA RELE' MINI	RELAY HOLDER	PORTE RELAIS	RELAISHALTER	PORTARELÉ





 IMPIANTO ELETTRICO DIESEL

ELEKTRISCHE ANLAGE DIESEL 

 ELECTRICAL SYSTEM DIESEL

INSTALACIÓN ELÉCTRICA DIESEL 

 INSTALLATION ÉLECTRIQUE DIESEL

POS Codice	Q.tà	 Descrizione	 Description	 Designation	 Benennung	 Descripcìon
16 1730720059	1 NR	CONNETTORE 29 VIE F MOTORE (X26)	CONNECTOR	CONNECTEUR	VERBINDER	CONECTADOR

 ADESIVI

 STICKER



AUFKLEBER 

PEGATINA 





 ADESIVIAUFKLEBER  STICKERPEGATINA 

POS Codice





Q.tà

 Descrizione Description Designation Benennung Descripció





 ADESIVIAUFKLEBER  STICKERPEGATINA 

POS Codice	Q.tà	 Descrizione	 Description	 Designation	 Benennung	 Descripció
0 06039600	4 NR	ADESIVO	STICKER	AUTOCOLLANT	AUFKLEBER	PEGATINA
0 06039700	9 NR	ADESIVO	STICKER	AUTOCOLLANT	AUFKLEBER	PEGATINA
0 06039700	8 NR	ADESIVO	STICKER	AUTOCOLLANT	AUFKLEBER	PEGATINA
0 06039900	12 NR	ADESIVO	STICKER	AUTOCOLLANT	AUFKLEBER	PEGATINA
0 06040300	4 NR	ADESIVO	STICKER	AUTOCOLLANT	AUFKLEBER	PEGATINA
0 06040500	2 NR	ADESIVO	STICKER	AUTOCOLLANT	AUFKLEBER	PEGATINA
0 06040900	6 NR	ADESIVO	STICKER	AUTOCOLLANT	AUFKLEBER	PEGATINA
0 06041200	6 NR	ADESIVO	STICKER	AUTOCOLLANT	AUFKLEBER	PEGATINA
0 06041300	13 NR	ADESIVO	STICKER	AUTOCOLLANT	AUFKLEBER	PEGATINA
0 06056300	2 NR	ADESIVO	STICKER	AUTOCOLLANT	AUFKLEBER	PEGATINA
0 06060000	1 NR	ADESIVO	STICKER	AUTOCOLLANT	AUFKLEBER	PEGATINA
0 06085900	1 NR	ADESIVO	STICKER	AUTOCOLLANT	AUFKLEBER	PEGATINA
0 06086000	1 NR	ADESIVO	STICKER	AUTOCOLLANT	AUFKLEBER	PEGATINA
0 06086700	2 NR	ADESIVO	STICKER	AUTOCOLLANT	AUFKLEBER	PEGATINA





 ADESIVIAUFKLEBER  STICKERPEGATINA 

POS Codice	Q.tà	 Descrizione	 Description	 Designation	 Benennung	 Descripción
0 06136900	2 NR	ADESIVO PUNTI INGRASSAGGIO Ø 55 TESTO NERO - SFONDO BIANCO (**)	STICKER GREASE POINTS Ø 55	AUTOCOLLANT POINTS GRAISSANGE Ø 55 TEXTE NOIR - FOND BLANC (**)	AUFKLEBER SCHMIERPUNKTE Ø 55, SCHWARZER TEXT - WEIßER UNTERGRUND	PEGATINS PUNTOS ENGRASE Ø 55 TEXTO NEGRO - FONDO BLANCO (**)
0 06164600	1 NR	ADESIVO	STICKER	AUTOCOLLANT	AUFKLEBER	PEGATINA
0 06164700	1 NR	ADESIVO	STICKER	AUTOCOLLANT	AUFKLEBER	PEGATINA
0 06165000	1 NR	ADESIVO	STICKER	AUTOCOLLANT	AUFKLEBER	PEGATINA
0 06214200	1 NR	ADESIVO	STICKER	AUTOCOLLANT	AUFKLEBER	PEGATINA
0 06227200	1 NR	ADESIVO "CONTROLLARE LIVELLO OLIO MOTORE " 7 LINGUE GIALLO L=82X108 (**)	DECAL	AUTOCOLLANT	AUFKLEBER	PEGATINA
0 06254800	1 NR	ADESIVO" STOP EMERGENZA" SFONDO GIALLO L=100X50 (**)	DECAL	AUTOCOLLANT	AUFKLEBER	PEGATINA
0 06448100	2 NR	ADESIVO	STICKER	AUTOCOLLANT	AUFKLEBER	PEGATINA
0 06448200	2 NR	ADESIVO	STICKER	AUTOCOLLANT	AUFKLEBER	PEGATINA
0 06520600	2 NR	ADESIVO	STICKER	AUTOCOLLANT	AUFKLEBER	PEGATINA





 ADESIVIAUFKLEBER  STICKERPEGATINA 

POS Codice	Q.tà	 Descrizione	 Description	 Designation	 Benennung	 Descripcìon
0 06555500	1 NR	ADESIVO	STICKER	AUTOCOLLANT	AUFKLEBER	PEGATINA
0 06555600	1 NR	ADESIVO	STICKER	AUTOCOLLANT	AUFKLEBER	PEGATINA
0 06555700	1 NR	ADESIVO	STICKER	AUTOCOLLANT	AUFKLEBER	PEGATINA
0 06555800	1 NR	ADESIVO	STICKER	AUTOCOLLANT	AUFKLEBER	PEGATINA
0 06665700	1 NR	ADESIVO POSIZIONE COMANDI DISCESA DI EMERGENZA L=100X90 MM	DECAL	AUTOCOLLANT	AUFKLEBER	AUTOCOLLANT
0 06704400	2 NR	ADESIVO REGOLAZIONE PATTINI SFILO L=120X60 BIANCO (**)	DECAL	AUTOCOLLANT	AUFKLEBER	PEGATINA
0 06706500	1 NR	ADESIVO	STICKER	AUTOCOLLANT	AUFKLEBER	PEGATINA
0 06713600	4 NR	ADESIVO	DECAL	AUTOCOLLANT	AUFKLEBER	PEGATINA
0 06931000	1 NR	ADESIVO	DECAL	AUTOCOLLANT	AUFKLEBER	PEGATINA
0 06931100	2 NR	ADESIVO	DECAL	AUTOCOLLANT	AUFKLEBER	PEGATINA
0 06931600	2 NR	ADESIVO	DECAL	AUTOCOLLANT	AUFKLEBER	PEGATINA
0 06998800	1 NR	ADESIVO	STICKER	AUTOCOLLANT	AUFKLEBER	PEGATINA





 ADESIVIAUFKLEBER  STICKERPEGATINA 

POS Codice	Q.tà	 Descrizione	 Description	 Designation	 Benennung	 Descripcìon
0 07034200	2 NR	ADESIVO	STICKER	AUTOCOLLANT	AUFKLEBER	PEGATINA
0 07056400	4 NR	ADESIVO	STICKER	AUTOCOLLANT	AUFKLEBER	PEGATINA
0 07056700	6 NR	ADESIVO	STICKER	AUTOCOLLANT	AUFKLEBER	PEGATINA
0 07058800	2 NR	ADESIVO	STICKER	AUTOCOLLANT	AUFKLEBER	PEGATINA
0 07060500	2 NR	ADESIVO	STICKER	AUTOCOLLANT	AUFKLEBER	PEGATINA
0 07071200	4 NR	ADESIVO	STICKER	AUTOCOLLANT	AUFKLEBER	PEGATINA
0 07206100	1 NR	ADESIVO	DECAL	AUTOCOLLANT	AUFKLEBER	PEGATINA
0 07240300	1 NR	ADESIVO	STICKER	AUTOCOLLANT	AUFKLEBER	PEGATINA
0 07264800	2 NR	ADESIVO	DECAL	AUTOCOLLANT	AUFKLEBER	PEGATINA
0 07268300	8 NR	ADESIVO	DECAL	AUTOCOLLANT	AUFKLEBER	PEGATINA
0 07268400	8 NR	ADESIVO	DECAL	AUTOCOLLANT	AUFKLEBER	PEGATINA
0 07350300	4 NR	ADESIVO	DECAL	AUTOCOLLANT	AUFKLEBER	PEGATINA
0 07633900	2 NR	ADESIVO	DECAL	AUTOCOLLANT	AUFKLEBER	PEGATINA
0 07668100	1 NR	ADESIVO PULSANTI DISTRIBUTORE PARTE AEREA LL2614 L=318X52 MM	DECAL	AUTOCOLLANT	AUFKLEBER	PEGATINA

 ADESIVIAUFKLEBER  STICKERPEGATINA 

POS Codice	Q.tà	 Descrizione	 Description	 Designation	 Benennung	 Descripcìon
0 07668200	1 NR	ADESIVO EMERGENCY STOP E BLOCCHETTO ACCENSIONE L=85X160 MM	DECAL	AUTOCOLLANT	AUFKLEBER	PEGATINA
0 07668300	1 NR	ADESIVO	DECAL	AUTOCOLLANT	AUFKLEBER	PEGATINA
0 07668400	4 NR	ADESIVO	DECAL	AUTOCOLLANT	AUFKLEBER	PEGATINA
0 07677500	2 NR	ADESIVO	DECAL	AUTOCOLLANT	AUFKLEBER	PEGATINA
0 07678300	4 NR	ADESIVO	DECAL	AUTOCOLLANT	AUFKLEBER	PEGATINA
0 07690100	2 NR	ADESIVO	DECAL	AUTOCOLLANT	AUFKLEBER	PEGATINA
0 07691500	1 NR	ADESIVO	DECAL	AUTOCOLLANT	AUFKLEBER	PEGATINA
0 07876000	1 NR	ADESIVO PORTATA CESTO 2 PERSONE LL1570 LITHIUM	STICKER BASKET CAPACITY 2 PEOPLE LL1570 LITHIUM	AUTOCOLLANT PANIER CAPACITÉ 2 PERSONNES LL1570 LITHIUM	AUFKLEBER KORB KAPAZITÄT 2 PERSONEN LL1570 LITHIUM	ETIQUETA DE CESTA DE LA CAPACIDAD 2 PERSONAS LL1570 LITIO
0 07876100	1 NR	ADESIVO PORTATA CESTO 2 PERSONE LL1370 LITHIUM	STICKER BASKET CAPACITY 2 PEOPLE LL1370 LITHIUM	AUTOCOLLANT PANIER CAPACITÉ 2 PERSONNES LL1370 LITHIUM	AUFKLEBER KORB KAPAZITÄT 2 PERSONEN LL1370 LITHIUM	ETIQUETA DE CESTA DE LA CAPACIDAD 2 PERSONAS LL1370 LITIO
0 1001125483	6 NR	ADESIVO	STICKER	AUTOCOLLANT	AUFKLEBER	PEGATINA





 ADESIVIAUFKLEBER  STICKERPEGATINA 

POS	Codice	Q.tà	 Descrizione	 Description	 Designation	 Benennung	 Descripció
0	1001125483	3	NR ADESIVO	STICKER	AUTOCOLLANT	AUFKLEBER	PEGATINA
0	1608710001	1	NR ADESIVO	STICKER	AUTOCOLLANT	AUFKLEBER	PEGATINA
0	1608710002	1	NR ADESIVO	STICKER	AUTOCOLLANT	AUFKLEBER	PEGATINA
0	1701504	1	NR ADESIVO	STICKER	AUTOCOLLANT	AUFKLEBER	PEGATINA
0	1701640	1	NR ADESIVO	STICKER	AUTOCOLLANT	AUFKLEBER	PEGATINA
0	1701644	1	NR ADESIVO JLG CAVO CARICABATTERIA	STICKER JLG CABLE CHARGER	AUTOCOLLANT	AUFKLEBER	PEGATINA
0	1702155	1	NR ADESIVO	STICKER	AUTOCOLLANT	AUFKLEBER	PEGATINA
0	1703813	1	NR ADESIVO	STICKER	AUTOCOLLANT	AUFKLEBER	PEGATINA
0	1703814	4	NR ADESIVO	STICKER	AUTOCOLLANT	AUFKLEBER	PEGATINA
0	1704277	2	NR ADESIVO	STICKER	AUTOCOLLANT	AUFKLEBER	PEGATINA
1	06042400	4	NR ADESIVO	STICKER	AUTOCOLLANT	AUFKLEBER	PEGATINA
2	06561200	4	NR ADESIVO	STICKER	AUTOCOLLANT	AUFKLEBER	PEGATINA
3	07056800	3	NR ADESIVO	STICKER	AUTOCOLLANT	AUFKLEBER	PEGATINA
4	07056700	8	NR ADESIVO	STICKER	AUTOCOLLANT	AUFKLEBER	PEGATINA
5	07194400	3	NR ADESIVO	DECAL	AUTOCOLLANT	AUFKLEBER	PEGATINA

 ADESIVI

 AUFKLEBER 
 STICKER

 PEGATINA 

POS Codice	Q.tà	 Descrizione	 Description	 Designation	 Benennung	 Descripción
6 07633800	2 NR	ADESIVO	DECAL	AUTOCOLLANT	AUFKLEBER	PEGATINA
7 07667000	1 NR	ADESIVO JLG PORTATA CESTO 2 PERSONE X26JPLUS L=135X145 MM	DECAL	AUTOCOLLANT	AUFKLEBER	PEGATINA
8 07878400	1 NR	ADESIVO CASCO IMBRAGATURA E DIVIETI LL1370 L=175X118 MM	STICKER HELMET HARNESS AND BANS	AUTOCOLLANT CASQUE HARNAIS ET INTERDICTION	STICKER HELMGURT UND VERBOTE	ETIQUETA ARNÉS CASCO Y PROHIBICIONES
9 1701505	1 NR	ADESIVO	STICKER	AUTOCOLLANT	AUFKLEBER	PEGATINA
10 1705828	1 NR	ADESIVO	STICKER	AUTOCOLLANT	AUFKLEBER	PEGATINA
11 1706098	1 NR	ADESIVO	STICKER	AUTOCOLLANT	AUFKLEBER	PEGATINA
12 1706493	1 NR	ADESIVO	STICKER	AUTOCOLLANT	AUFKLEBER	PEGATINA
13 07499300	1 NR	ADESIVO DON'T OPEN THE CASE SFONDO GIALLO L=60X17 MM	DECAL	AUTOCOLLANT	AUFKLEBER	PEGATINA

Cod. 17107300

KIT INTEGRAZIONE ADESIVI PER PIATTAFORME AEREE LITHIUM-ANSI
INTEGRATION KIT STICKERS PLATFORMS LITHIUM-ANSI

X370AJ • X390AJ • X430AJ • X500AJ • X550AJ • X600AJ • X700AJ • X770AJ

Da usare in aggiunta ai seguenti kit di sicurezza /
To use in addition to the following safety kit

X370AJcod.17788300
X390AJcod.17065200
X430AJ.....cod.17788300
X500AJ / MK2.....cod. 17776800
X550AJ.....cod. 17065300
X600AJ / MK2.....cod. 17777000
X700AJ.....cod. 17065400
X770AJ.....cod. 17633600

+ kit in lingua non inclusi nel codice generale / language code not included in the standard kit

+171073GB + 171073FR + 171073ES + 171073PT

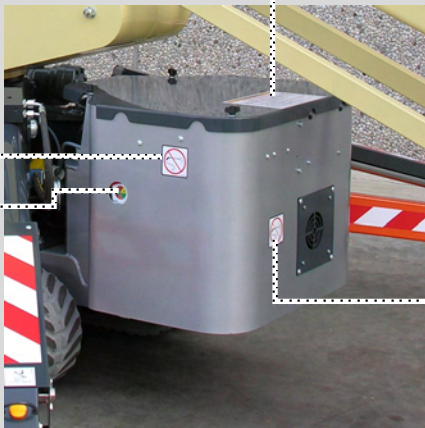

KIT ADESIVI - X390AJ

SET OF DECALS - X390AJ

KIT COLLANTS - X390AJ

AUFKLEBERSATZ - X390AJ

KIT ADHESIVOS - X390AJ

ADHESIEKIT - X390AJ

cod. 17107300

Tav 01

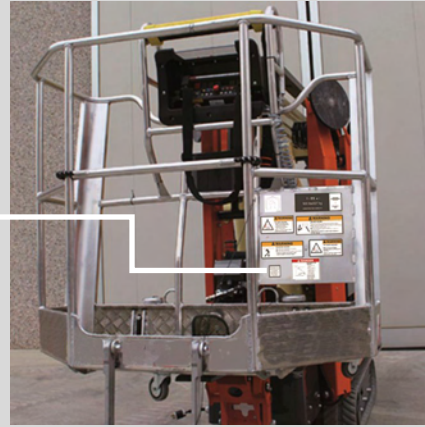
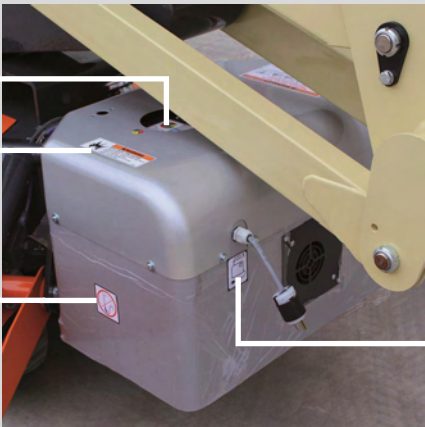

KIT ADESIVI - X370AJ / X430AJ

SET OF DECALS - X370AJ / X430AJ

KIT COLLANTS - X370AJ / X430AJ

AUFKLEBERSATZ - X370AJ / X430AJ

KIT ADHESIVOS - X370AJ / X430AJ

ADHESIEKIT - X370AJ / X430AJ

cod. 17107300

Tav 01



3

11

3

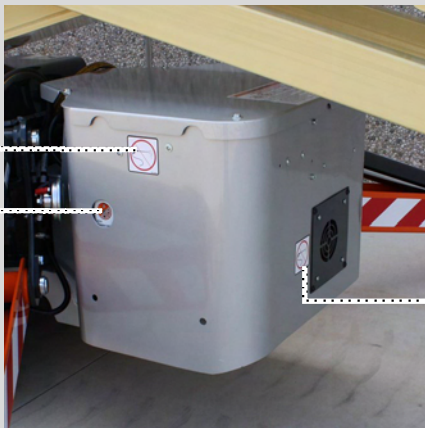

1

4

1

1

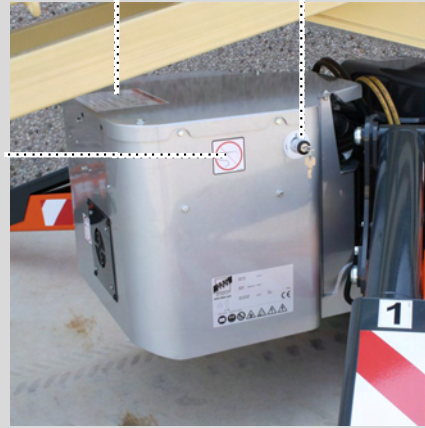

8

2

1

1

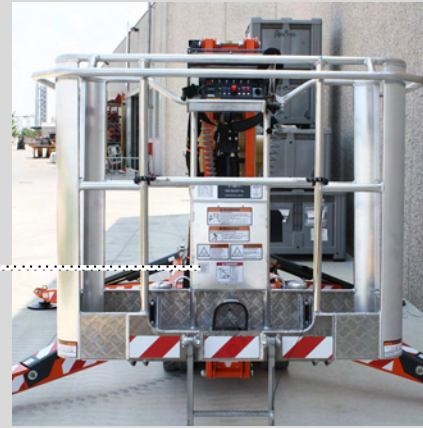

9

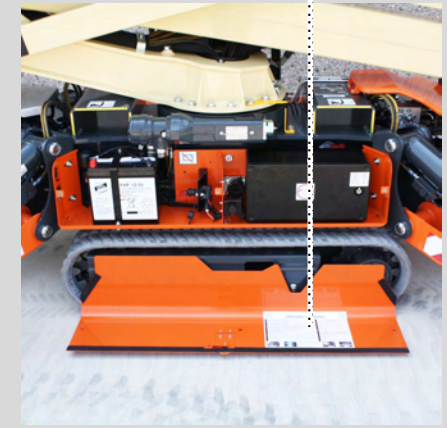

10

KIT ADESIVI - X500AJ

SET OF DECALS - X500AJ

KIT COLLANTS - X500AJ

AUFKLEBERSATZ - X500AJ

KIT ADHESIVOS - X500AJ

ADHESIEKIT - X500AJ

cod. 17107300

Tav 01

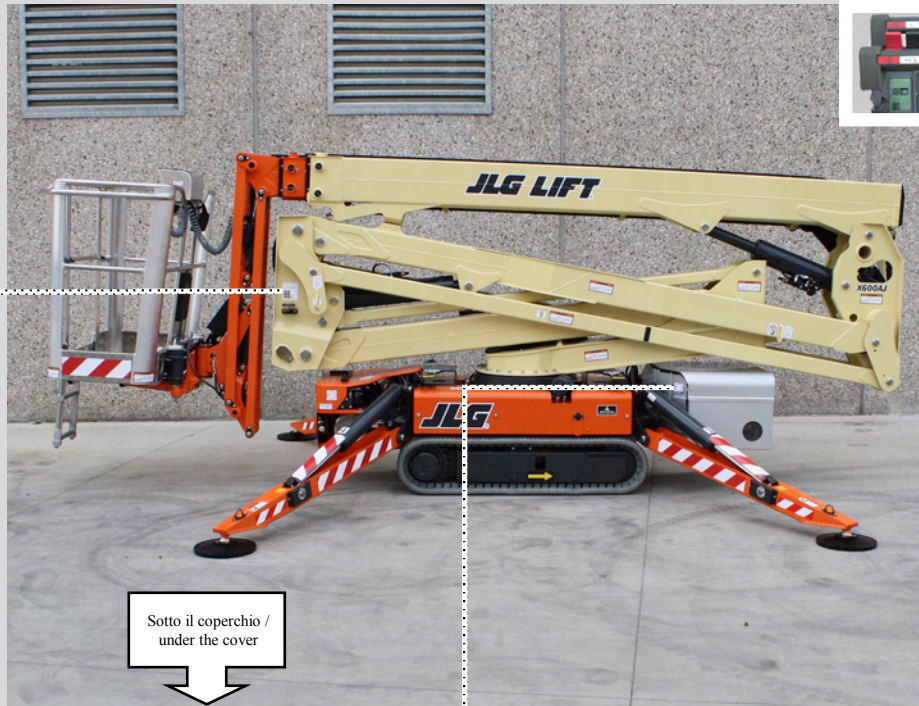

Sotto il coperchio /
under the cover



KIT ADESIVI - X600AJ

SET OF DECALS - X600AJ

KIT COLLANTS - X600AJ

AUFKLEBERSATZ - X600AJ

KIT ADHESIVOS - X600AJ

ADHESIEKIT - X600AJ

cod. 17107300

Tav 01



11

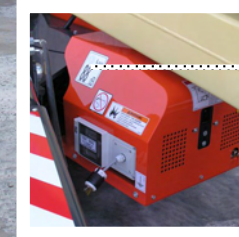

Sotto il coperchio /
under the cover

3

3



8



2

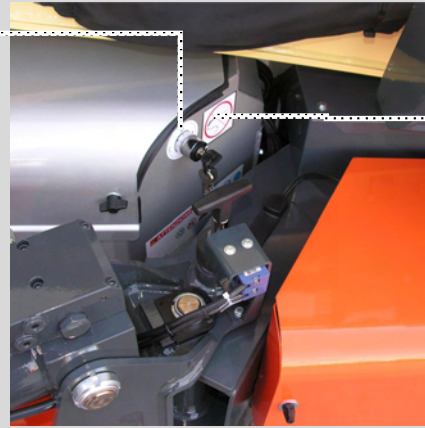

1

9

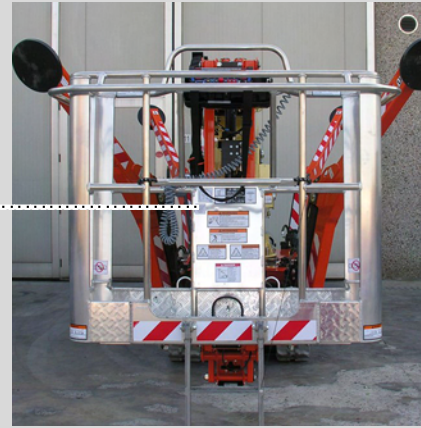

5 5 1

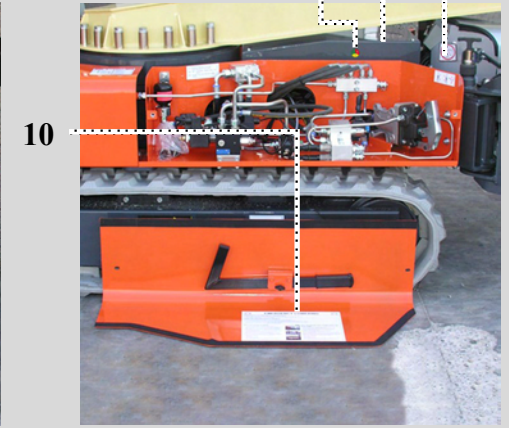

10

KIT ADESIVI - X700AJ

SET OF DECALS - X700AJ

KIT COLLANTS - X700AJ

AUFKLEBERSATZ - X700AJ

KIT ADHESIVOS - X700AJ

ADHESIEKIT - X700AJ

cod. 17107300

Tav 01



Sotto il coperchio /
under the cover

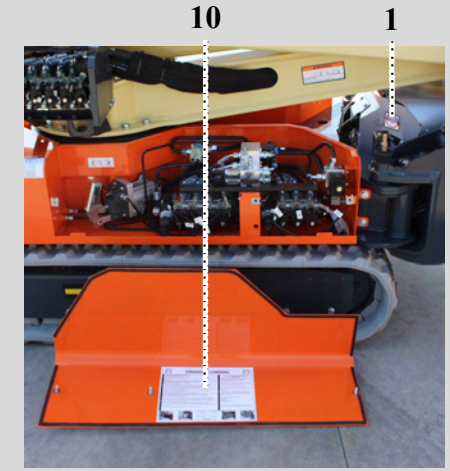
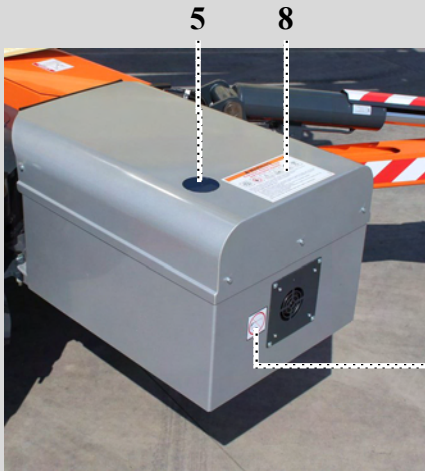

KIT ADESIVI - X770AJ

SET OF DECALS - X770AJ

KIT COLLANTS - X770AJ

AUFKLEBERSATZ - X770AJ

KIT ADHESIVOS - X770AJ

ADHESIEKIT - X770AJ

cod. 17107300

Tav 01

POS.	COD.	DESCRIZIONE / DESCRIPTION	Q.tà
01	1001125483	ADESIVO JLG VIETATO LAVARE L=63,5X63,5 MM	03
02	06506400	ADESIVO " CHIAVE DI ACCENSIONE" ESTERNO Ø 49 FORO Ø 22 SERIE LITHIUM ION _MOD_B (**)	01
03	06520600	ADESIVO RUMORE 88 dB L=90x100 MM _MOD_B (**)	02
04	07264700	ADESIVO INDICATORE LED CARICABATTERIE 48V (Ø EST.31MM Ø INT.6 MM) VECCHIO BMS (FINO A C170000329)	01
	07394800	ADESIVO INDICATORE LED CARICABATTERIE 48V (Ø EST.31MM Ø INT.6 MM) NUOVO BMS/4 (DA C170000330)	01
05	07264800	ADESIVO INDICATORE LED RICARICA BATTERIE Ø EST.21MM Ø INT.4 MM	02
06	1701644	ADESIVO JLG CAVO CARICABATTERIA L: 50,8X63,5 MM	01
07	1703813	ADESIVO JLG PERICOLO ESPLOSIONE BATTERIE - ING L=149,25X47,62 MM	01
08			
09			
10			
11	07194400	ADESIVO BOLLINO PER TELECOMANDO SERE IIIS COLORE GRIGIO Ø 10,50 MM	03
12			
13			
14			
15			
16			
17			
18			
19			
20			
21			

AGGIORNATO IL / UPDATED 18/09/2017

**KIT ADESIVI SICUREZZA PIATTAFORMA AEREA /
*AERIAL PLATFORM KIT STICKERS SAFETY***

JLG/CE - X26JPLUS

Cod. 17633400

+ codici kit in lingua / + *kit codes in language*

**176334IT / 176334GB / 176334FR / 176334DE / 176334ES / 176334NL /
176334SW / 176334PT / 176334DA / 176334NO / 176334RU /
176334PL / 176334SL / 176334FI / 176334CE / 176334JA /**

DA USARE CON / FOR USE WITH

**17633500 KIT ADESIVI COMMERCIALI PIATTAFORMA AEREA JLG/CE X26JPLUS
*STICKER KITS COMMERCIAL AERIAL PLATFORM***

**17187700 KIT INTEGRAZIONE ADESIVI PER PIATTAFORME AEREE JLG/CE LITHIUM /
*INTEGRATION KIT STICKERS PLATFORMS JLG / CE LITHIUM***

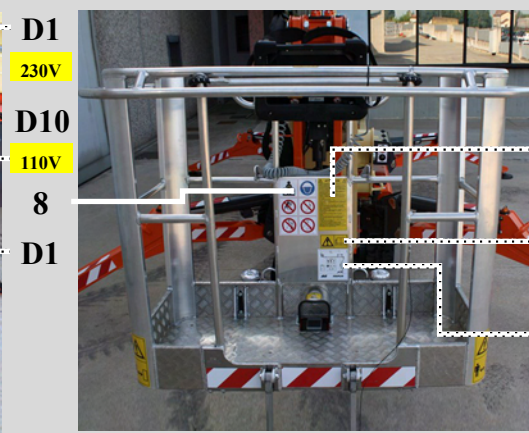
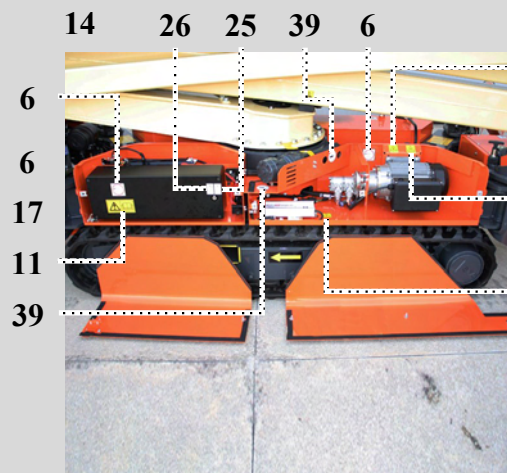
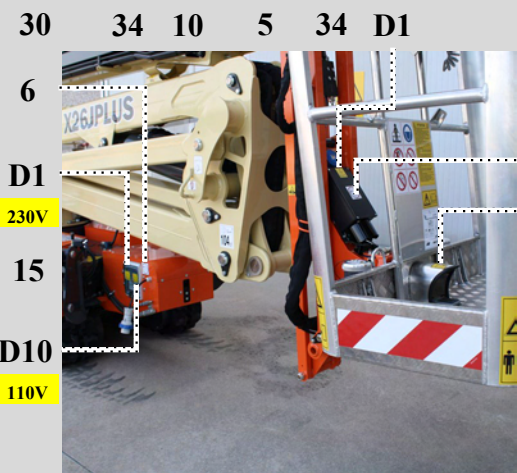
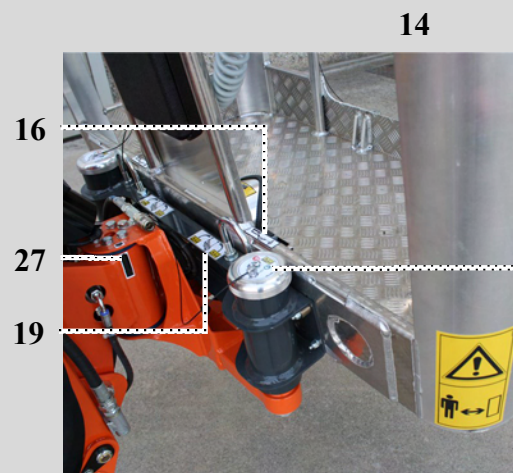
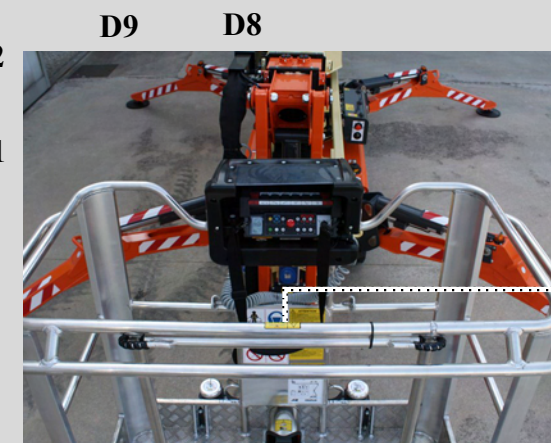
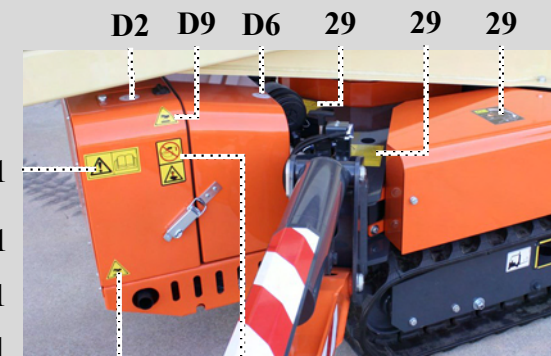
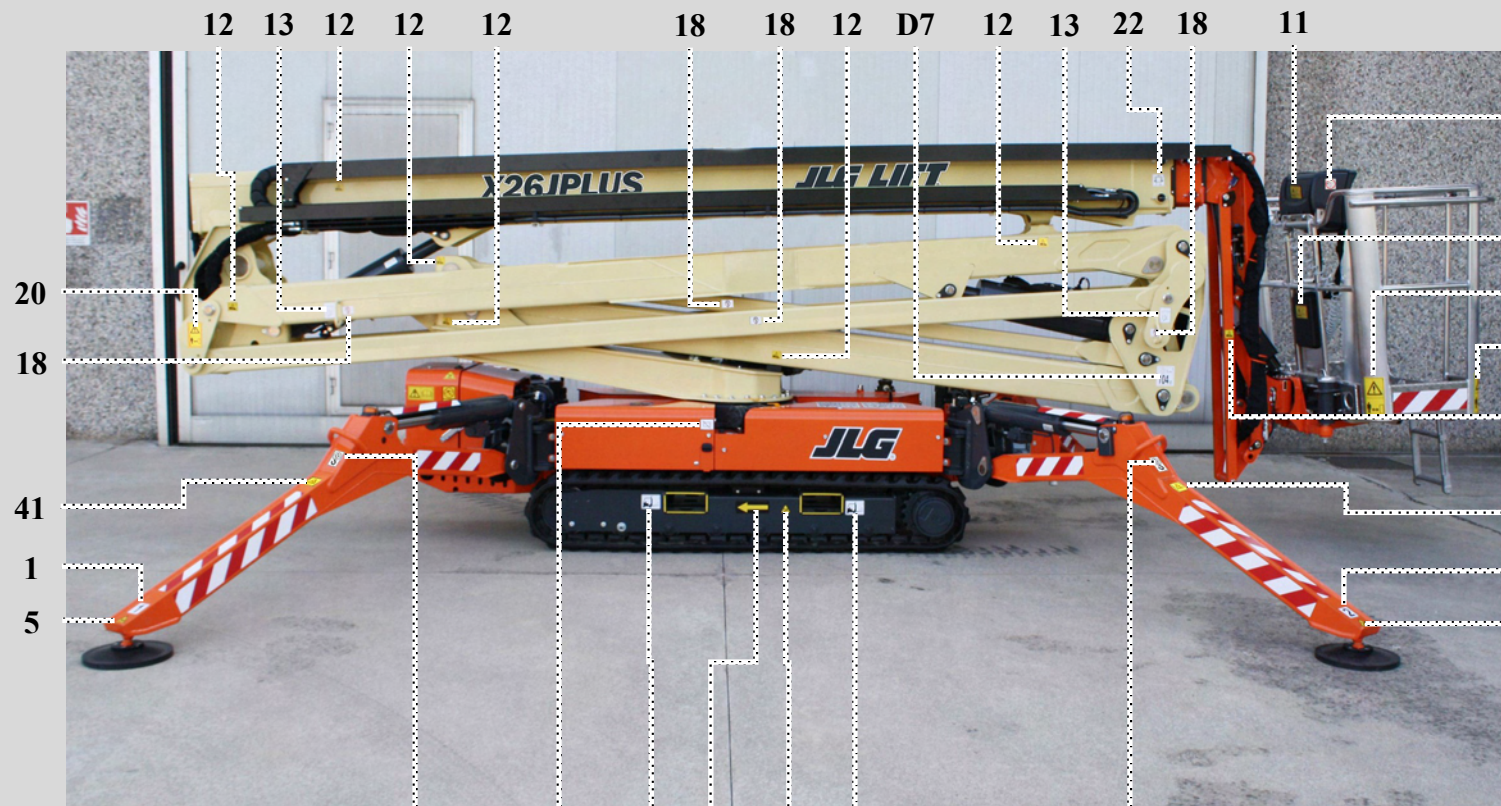

KIT ADESIVI - JLG/CE - X26JPLUS
 SET OF DECALS - JLG/CE - X26JPLUS
 KIT COLLANTS - JLG/CE - X26JPLUS

AUFKLEBERSATZ - JLG/CE - X26JPLUS
 KIT ADHESIVOS - JLG/CE - X26JPLUS
 ADHESIEKIT - JLG/CE - X26JPLUS

cod. 17633400

Ed. 18/09/2017 | Tav 01

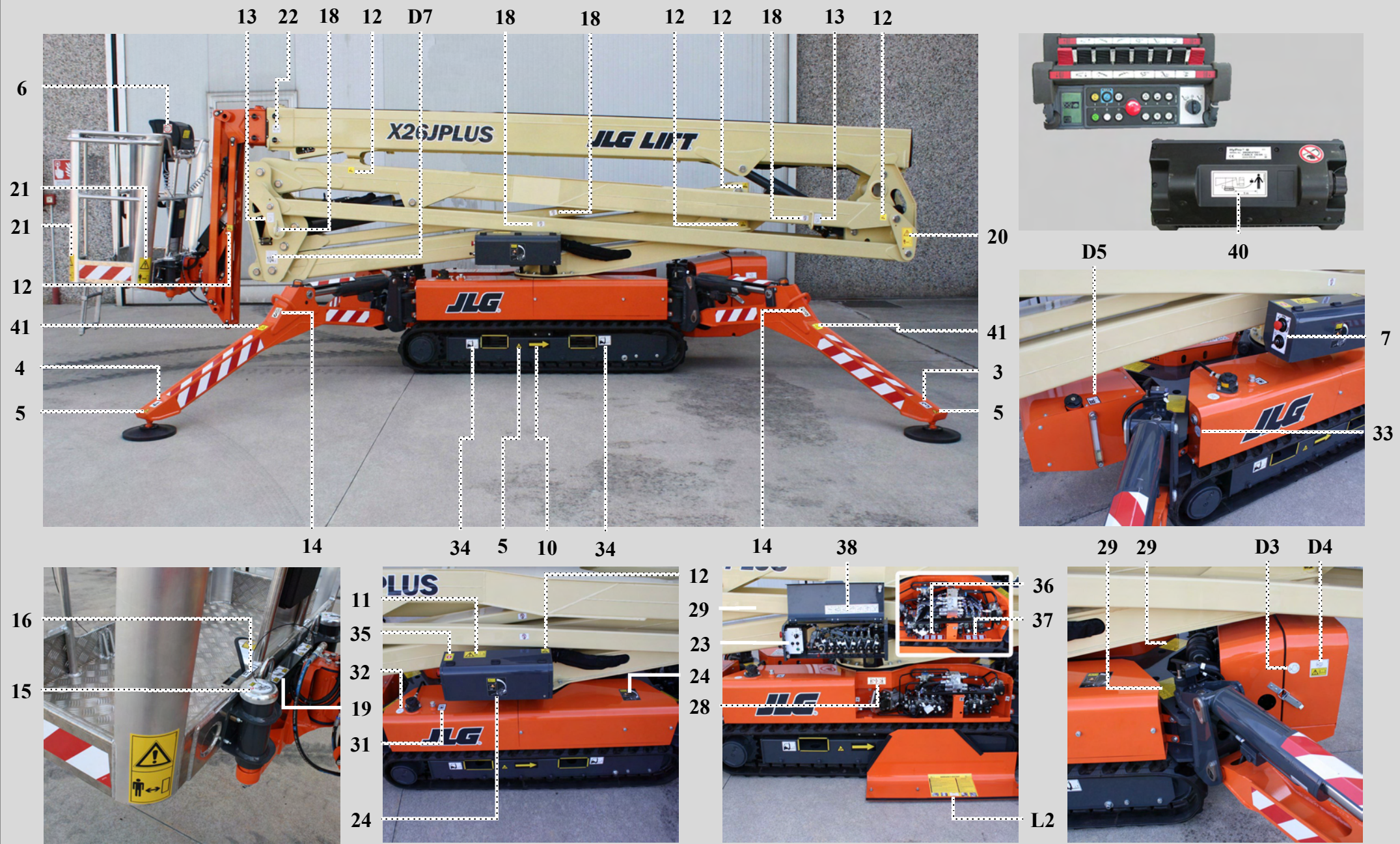

KIT ADESIVI - JLG/CE - X26JPLUS

SET OF DECALS - JLG/CE - X26JPLUS

KIT COLLANTS - JLG/CE - X26JPLUS

AUFKLEBERSATZ - JLG/CE - X26JPLUS

KIT ADHESIVOS - JLG/CE - X26JPLUS

ADHESIEKIT - JLG/CE - X26JPLUS

cod. 17633400

Ed. 18/09/2017

Tav 02

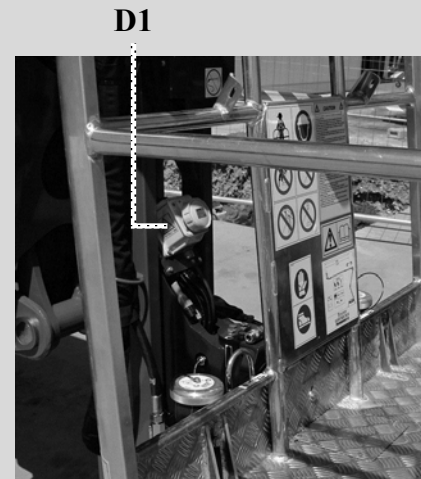
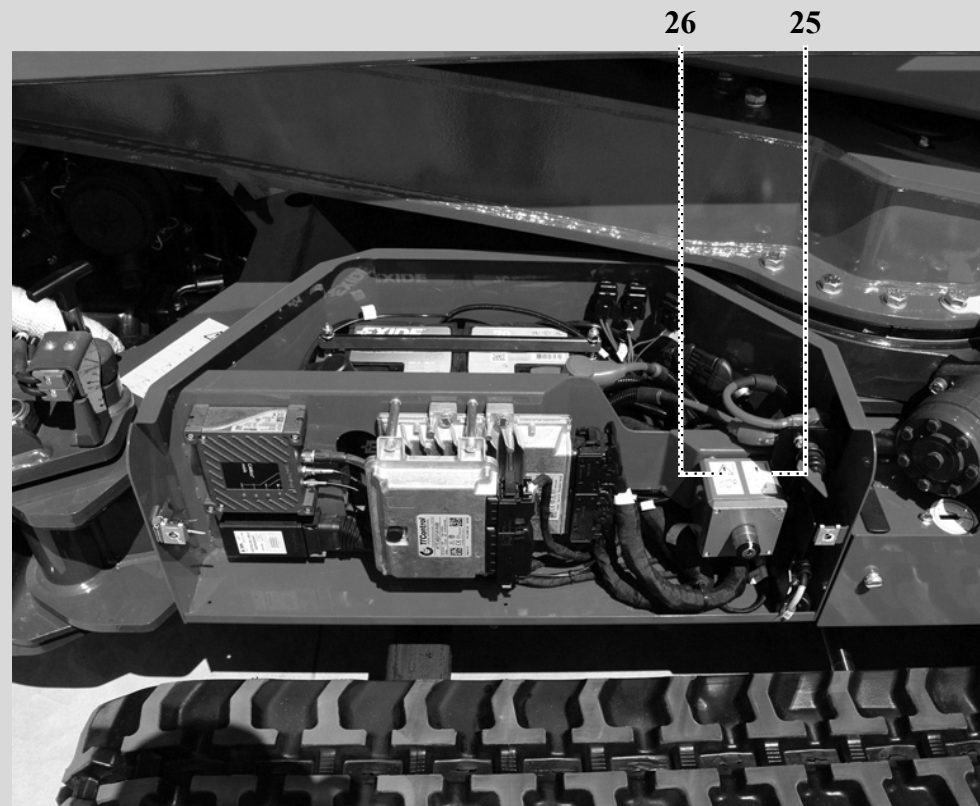

KIT ADESIVI - JLG/CE - X26JPLUS/200

AUFKLEBERSATZ - JLG/CE - X26JPLUS/200

SET OF DECALS - JLG/CE - X26JPLUS/200

KIT ADHESIVOS - JLG/CE - X26JPLUS/200

KIT COLLANTS - JLG/CE - X26JPLUS/200

ADHESIEKIT - JLG/CE - X26JPLUS/200

cod. 17633400

Ed. 18/09/2017

Tav 03

JLG/CE - X26JPLUS COD. 17633400 POSIZIONE ADESIVI IN DISTINTA MACCHINA /
ADHESIVE POSITION IN THE DISTINCT OF THE MACHINE

POS.	COD.	REV.	ADESIVI IN DISITINTA / STICKERS IN LIST	Q.tà
D1	06561200	B	ADESIVO PERICOLO 230 VOLT 16A GIALLO 47X47 MM _MOD_B	05
	06042400	B	ADESIVO PERICOLO 110 VOLT 16A GIALLO _MOD_B	05
D2	06214200	A	ADESIVO LIQUIDO REFRIGERANTE SFONDO BIANCO Ø 50 MM	01
D3	06060000	A	ADESIVO LIVELLO OLIO MOTORE Ø50 MM	01
D4	06227200	B	ADESIVO CONTROLLARE LIVELLO OLIO MOTORE L=80X80 MM _MOD_B	01
D5	1701505	A	ADESIVO JLG CARBURANTE DIESEL L= 50,8X63,5 MM (**)	01
D6	06164600	A	ADESIVO FILTRO ARIA Ø50 SFONDO BIANCO	01
D7	07034200	B	ADESIVO RUMORE 104 dB L=90X100 MM _MOD_B	02
D8	1706098	B	ADESIVO JLG PERICOLO ESPLOSIONE L=63,5X117,475 MM _MOD_B (**)	01
D9	06056300	A	ADESIVO PERICOLO SCOTTATURE TRIANGOLARE SFONDO GIALLO L=60X51 MM	02
D10	07668000	A	ADESIVO PERICOLO 110 VOLT 32A GIALLO L=47 X 47 MM	02
D11				
D12				
D13				
D14				
D15				
D16				
D17				
D18				
D19				
D20				
D21				
D22				
D23				
D24				

JLG/CE - X26JPLUS COD. 17633400 POSIZIONE ADESIVI / POSITION ADHESIVE

JLG

POS.	COD.	REV.	DESCRIZIONE / DESCRIPTION	Q.tà
01	06555500	A	ADESIVO NR 1 L=50X60 MM BIANCO	01
02	06555600	A	ADESIVO NR 2 L=50X60 MM BIANCO	01
03	06555700	A	ADESIVO NR 3 L=50X60 MM BIANCO	01
04	06555800	A	ADESIVO NR 4 L=50X60 MM BIANCO	01
05	06041200	A	ADESIVO SCHIACCIAMENTO PIEDI TRIANGOLARE - GIALLO L=53X46 MM	06
06	1001125483	A	ADESIVO JLG VIETATO LAVARE L=63,5X63,5 MM	06
07	07668200	B	ADESIVO EMERGENCY STOP E BLOCCHETTO ACCENSIONE L=85x160 MM _MOD_B	01
08	07878400	A	ADESIVO CASCO IMBRAGATURA E DIVIETI LL1370 L=175X118 MM	01
09	1706493	B	ADESIVO JLG SCORRIMENTO SBARRA CHIUSURA CESTO L= 76,2X25,4 MM _MOD_B	01
10	06040500	A	ADESIVO DIREZ. TRASLAZIONE FRECCIA GIALLA SFONDO NERO L=61 X 160 MM	02
11	06040900	A	ADESIVO LEGGERE IL MANUALE GIALLO L=125 X 65 MM	06
12	06041300	B	ADESIVO ATTENZIONE PERICOLO TAGLI L=35 X 40 MM GIALLO _MOD_B	13
13	1703814	A	ADESIVO JLG ATTACCO ANCORAGGIO L=55,56X76,2 MM	04
14	07071200	A	ADESIVO JLG PUNTO DI SOLLEVAMENTO L= 40X66 MM	04
15	06448200	B	ADESIVO "SBLOCCARE SOLO NEI CASI PREVISTI" Ø 60 MM _MOD_B	02
16	1704277	A	ADESIVO JLG ATTACCO CINTURE DI SICUREZZA L= 76,2X19,05 MM	02
17	1705828	B	ADESIVO JLG INTERUTTORE PEDALE L= 69,85X54 _MOD_B	01
18	07056700	A	ADESIVO JLG DIVIETO DI SOLLEVAMENTO L=54,88X40 MM	08
19	06448100	B	ADESIVO RIPRISTINARE I TAPPI FERMO GUIDA L= 100X35 MM _MOD_B	02
20	07058800	A	ADESIVO PERICOLO MANTENERE LE DISTANZE L=65X130 MM	02
21	06040300	A	ADESIVO PERICOLO MANTENERE LE DISTANZE GIALLO L=100 X 200 MM (**)	04
22	06704400	B	ADESIVO REGOLAZIONE PATTINI SFILO BIANCO _MOD_B (**)	02
23	07668300	A	ADESIVO SELETTORE SCATOLA TERRA / CESTO L=105X155 MM	01
24	07056800	B	ADESIVO JLG DISCESA DI EMERGENZA ALL'INTERNO L=114X130 MM _MOD_B	03

JLG/CE - X26JPLUS COD. 17633400 POSIZIONE ADESIVI / POSITION ADHESIVE

JLG

POS.	COD.	REV.	DESCRIZIONE / DESCRIPTION	Q.tà
25	06086000	A	ADESIVO SISTEMA BYPASS TRASLAZIONE L=30X50 MM	01
26	06085900	A	ADESIVO SISTEMA BYPASS PARTE AEREA L=30X50MM	01
27	06706500	A	ADESIVO ALLINEAMENTO CESTO (2 PEZZI) L=16X50 MM	01
28	06998800	A	ADESIVO DEVIATORE POMPA MANUALE PIATTAFORMA GL17.80XL L=86X34 MM	01
29	06713600	B	ADESIVO CONTROLLO MICRON STABILIZZATORI GIALLO _MOD_B	04
30	1702155	A	ADESIVO JLG STACCABATTERIA L= 63,5X50,80 MM	01
31	1701504	A	ADESIVO JLG OLIO IDRAULICO L=50,8x63,5 MM	01
32	06164700	A	ADESIVO FILTRO OLIO SFONDO BIANCO Ø50 MM	01
33	06165000	A	ADESIVO LIVELLO OLIO IDRAULICO SFONDO BIANCO Ø50 MM	01
34	07350300	A	ADESIVO SOLLEVAMENTO PIATTAFORMA CON MULETTO L=90X70 MM	04
35	06254800	B	ADESIVO STOP EMERGENZA SFONDO GIALLO L=70X50 MM _MOD_B	01
36	1608710001	C	ADESIVO PULSANTI DISTRIBUTORE A TERRA LATO SX GL17.80 L=194X50 MM _MOD_C	01
37	1608710002	C	ADESIVO PULSANTI DISTRIBUTORE A TERRA LATO DX GL17.80 L=150X50 MM _MOD_C	01
38	07668100	A	ADESIVO PULSANTI DISTRIBUTORE PARTE AEREA LIGHT LIFT 2614 L=318X52 MM -	01
39	06136900	A	ADESIVO PUNTI DI INGRASSAGGIO Ø 55 mm	02
40	07240300	B	ADESIVO DISTANZA 1 METRO SU TELE/RADIO COMANDI L= 75x35 MM _MOD_B	01
41	07668400	A	ADESIVO REAZIONE AL SUOLO STABILIZZATORI LIGHT LIFT 2614 L=45x48 MM	04
42	07667000	A	ADESIVO JLG PORTATA CESTO 2 PERS. X26JPLUS L=135X145 MM	01
43				
44				
45				
			PER MACCHINE CON CESTO A 1 PERSONA / FOR MACHINE WITH BASKET 1 PERSON	
42	07676200	A	ADESIVO PORTATA CESTO 1 PERSONA X26JPLUS L=135X145 MM (non in distinta)	01

JLG/CE - X26JPLUS COD. 176334 POSIZIONE ADESIVI IN LINGUA / POSITION LANGUAGE STICKERS**

POS.	COD.	REV.	DESCRIZIONE / DESCRIPTION	Q.tà
	176334IT		ADESIVI SICUREZZA PIATTAFORMA AEREA X26JPLUS - LINGUA ITALIANO	
L1	06555300	C	ADESIVO USO PIATTAFORMA AEREA CINGOLATA - ITALIANO L=128X230 _MOD_C	01
L2	076685IT	B	ADESIVO DISCESA DI EMERG LL2614 MOTORE TERMICO E LITHIUM - ITALIANO - L=290X205 MM _MOD_B	01
	176334GB		ADESIVI SICUREZZA PIATTAFORMA AEREA X26JPLUS - LINGUA INGLESE	
L1	06562600	C	ADESIVO USO PIATTAFORMA AEREA CINGOLATA - INGLESE L=128X230 _MOD_C	01
L2	076685GB	B	ADESIVO DISCESA DI EMERGENZA LL2614 MOTORE TERMICO E LITHIUM - INGLESE L=290X205 MM _MOD_B	01
	176334FR		ADESIVI SICUREZZA PIATTAFORMA AEREA X26JPLUS - LINGUA FRANCESE	
L1	06562700	C	ADESIVO USO PIATTAFORMA AEREA CINGOLATA - FRANCESE L=128X230 _MOD_C	01
L2	076685FR	B	ADESIVO DISCESA DI EMERGENZA LL2614 MOTORE TERMICO E LITHIUM - FRANCESE L=290X205 MM _MOD_B	01
	176334DE		ADESIVI SICUREZZA PIATTAFORMA AEREA X26JPLUS - LINGUA TEDESCO	
L1	06562800	C	ADESIVO USO PIATTAFORMA AEREA CINGOLATA - TEDESCO L=128X230 _MOD_C	01
L2	076685DE	B	ADESIVO DISCESA DI EMERGENZA LL2614 MOTORE TERMICO E LITHIUM - TEDESCO L=290X205 MM _MOD_B	01
	176334ES		ADESIVI SICUREZZA PIATTAFORMA AEREA X26JPLUS - LINGUA SPAGNOLO	
L1	06562900	C	ADESIVO USO PIATTAFORMA AEREA CINGOLATA - SPAGNOLO L=128X230 _MOD_C	01
L2	076685ES	C	ADESIVO DISCESA DI EMERGENZA LL2614 MOTORE TERMICO E LITHIUM - SPAGNOLO L=290X205 MM _MOD_C	01
	176334NL		ADESIVI SICUREZZA PIATTAFORMA AEREA X26JPLUS - LINGUA OLANDESE	
L1	06563000	C	ADESIVO USO PIATTAFORMA AEREA CINGOLATA - OLANDESE L=128X230 _MOD_C	01
L2	076685NL	B	ADESIVO DISCESA DI EMERGENZA LL2614 MOTORE TERMICO E LITHIUM - OLANDESE L=290X205 MM _MOD_B	01

JLG/CE - X26JPLUS COD. 176334 POSIZIONE ADESIVI IN LINGUA / POSITION LANGUAGE STICKERS**

POS.	COD.	REV.	DESCRIZIONE / DESCRIPTION	Q.tà
	176334SW		ADESIVI SICUREZZA PIATTAFORMA AEREA X26JPLUS - LINGUA SVEDESE	
L1	07137300	C	ADESIVO USO PIATTAFORMA AEREA CINGOLATA - SVEDESE L= 128X230 MM _MOD_C	01
L2	076685SW	B	ADESIVO DISCESA DI EMERGENZA LL2614MOTORE TERMICO E LITHIUM - SVEDESE L=290X205 MM _MOD_B	01
	176334PT		ADESIVI SICUREZZA PIATTAFORMA AEREA X26JPLUS - LINGUA PORTOGHESE	
L1	06563100	C	ADESIVO USO PIATTAFORMA AEREA CINGOLATA - PORTOGHESE L=128X230 _MOD_C	01
L2	076685PT	B	ADESIVO DISCESA DI EMERG. LL2614 MOTORE TERMICO E LITHIUM - PORTOGHESE L=290X205 MM _MOD_B	01
	176334DA		ADESIVI SICUREZZA PIATTAFORMA AEREA X26JPLUS - LINGUA DANESE	
L1	07138100	C	ADESIVO USO PIATTAFORMA AEREA CINGOLATA - DANESE L= 128X230 MM _MOD_C	01
L2	076685DA	B	ADESIVO DISCESA DI EMERGENZA LL2614 MOTORE TERMICO E LITHIUM - DANESE L=290X205 MM _MOD_B	01
	176334NO		ADESIVI SICUREZZA PIATTAFORMA AEREA X26JPLUS - LINGUA NORVEGESE	
L1	07162000	C	ADESIVO USO PIATTAFORMA AEREA CINGOLATA - NORVEGESE L=128X230 MM _MOD_C	01
L2	076685NO	B	ADESIVO DISCESA DI EMERGENZA LL2614 MOTORE TERMICO E LITHIUM - NORVEGESE L=290X205 MM _MOD_B	01
	176334RU		ADESIVI SICUREZZA PIATTAFORMA AEREA X26JPLUS - LINGUA RUSSO	
L1	07514800	A	ADESIVO USO PIATTAFORMA AEREA CINGOLATA - RUSSO L=128X230 MM	01
L2	076685RU	B	ADESIVO DISCESA DI EMERG LL2614 MOTORE TERMICO E LITHIUM - RUSSO - L=290X205 MM _MOD_B	01
	176334PL		ADESIVI SICUREZZA PIATTAFORMA AEREA X26JPLUS - LINGUA POLACCO	
L1	07506600	B	ADESIVO USO PIATTAFORMA AEREA CINGOLATA - POLACCO L= 128X230MM _MOD_B	01
L2	076685PL	B	ADESIVO DISCESA DI EMERG LL2614 MOTORE TERMICO E LITHIUM - POLACCO - L=290X205 MM _MOD_B	01

F gwci riq'f kuvpvc

distinta 17633400	Descrizione KIT ADESIVI DI SICUREZZA PER PIATTAFORMA AEREA JLG/CE - X2			quantità componenti percentuale <input type="checkbox"/>	Disegno
Tipo Articolo	Data creazione 21/05/2015	Data ultimo aggiorn 18/09/2017	Unità di misura NR	Nota	

Tipo	Componente	Descrizione	N.F.	Da Espl.	Quantità	Qtà perc.	Un. mis.	Quantità sfridi	Un. mis.	Nota
Articolo	06555500	ADESIVO NR 1 BIANCO L=50X60 MM		Si	1,00	0,00	NR	0,00	NR	
Articolo	06555600	ADESIVO NR 2 BIANCO L=50X60 MM		Si	1,00	0,00	NR	0,00	NR	
Articolo	06555700	ADESIVO NR 3 BIANCO L=50X60 MM		Si	1,00	0,00	NR	0,00	NR	
Articolo	06555800	ADESIVO NR 4 BIANCO L=50X60 MM		Si	1,00	0,00	NR	0,00	NR	
Articolo	06041200	ADESIVO SCHIACCIAMENTO PIEDI TRIANGOLARE L=53X46 MM		Si	6,00	0,00	NR	0,00	NR	
Articolo	1001125483	ADESIVO JLG VIETATO LAVARE L=63,5X63,5 MM		Si	6,00	0,00	NR	0,00	NR	
Articolo	07668200	ADESIVO EMERGENCY STOP E BLOCCHETTO ACCENSIONE L=85x160 MM_MOD_B		Si	1,00	0,00	NR	0,00	NR	
Articolo	07878400	ADESIVO CASCO IMBRAGATURA E DIVIETI LL1370 L=175X118 MM		Si	1,00	0,00	NR	0,00	NR	
Articolo	1706493	ADESIVO JLG SCORRIMENTO SBARRA CHIUSURA CESTO L= 76,2X25,4 MM_MOD_B		Si	1,00	0,00	NR	0,00	NR	
Articolo	06040500	ADESIVO DIREZIONE TRASLAZIONE FRECCIA GIALLA SFONDO NERO L=61 X 160 MM		Si	2,00	0,00	NR	0,00	NR	
Articolo	06040900	ADESIVO LEGGERE IL MANUALE GIALLO L=125 X 65 MM		Si	6,00	0,00	NR	0,00	NR	
Articolo	06041300	ADESIVO ATTENZIONE PERICOLO TAGLI L=35 X 40 MM GIALLO_MOD_B		Si	13,00	0,00	NR	0,00	NR	
Articolo	1703814	ADESIVO JLG ATTACCO ANCORAGGIO L=55,56X76,2 MM		Si	4,00	0,00	NR	0,00	NR	
Articolo	07071200	ADESIVO JLG PUNTO DI SOLLEVAMENTO L= 40X66 MM		Si	4,00	0,00	NR	0,00	NR	
Articolo	06448200	ADESIVO "SBLOCCARE SOLO NEI CASI PREVISTI" Ø 60 MM_MOD_B		Si	2,00	0,00	NR	0,00	NR	
Articolo	1704277	ADESIVO JLG ATTACCO CINTURE DI SICUREZZA L= 76,2X19,05 MM		Si	2,00	0,00	NR	0,00	NR	
Articolo	1705828	ADESIVO JLG INTERRUETTORE PEDALE L= 69,85X54_MOD_B		Si	1,00	0,00	NR	0,00	NR	
Articolo	07056700	ADESIVO JLG DIVIETO DI SOLLEVAMENTO L=54,88X40		Si	8,00	0,00	NR	0,00	NR	
Articolo	06448100	ADESIVO RIPRISTINARE I TAPPI FERMO GUIDA L= 100X35 MM_MOD_B		Si	2,00	0,00	NR	0,00	NR	
Articolo	07058800	ADESIVO PERICOLO MANTENERE LE DISTANZE L=65X130 MM - GIALLO		Si	2,00	0,00	NR	0,00	NR	
Articolo	06040300	ADESIVO PERICOLO MANTENERE LE DISTANZE GIALLO L=100 X 200 MM		Si	4,00	0,00	NR	0,00	NR	

F gwci riq'f kuvpvc

distinta 17633400	Descrizione KIT ADESIVI DI SICUREZZA PER PIATTAFORMA AEREA JLG/CE - X2			quantità componenti percentuale <input type="checkbox"/>	Disegno
Tipo Articolo	Data creazione 21/05/2015	Data ultimo aggiorn 18/09/2017	Unità di misura NR	Nota	

Tipo	Componente	Descrizione	N.F.	Da Espl.	Quantità	Qtà perc.	Un. mis.	Quantità sfridi	Un. mis.	Nota
Articolo	06704400	ADESIVO REGOLAZIONE PATTINI SFILO BIANCO_MOD_B (**)		Si	2,00	0,00	NR	0,00	NR	
Articolo	07668300	ADESIVO SELETTORE SCATOLA COMANDI TERRA / CESTO L=105X155 MM		Si	1,00	0,00	NR	0,00	NR	
Articolo	07056800	ADESIVO JLG DISCESA DI EMERGENZA ALL'INTERNO L=114X130 MM_MOD_B		Si	3,00	0,00	NR	0,00	NR	
Articolo	06086000	ADESIVO SISTEMA BYPASS TRASLAZIONE L=30X50 MM (**)		Si	1,00	0,00	NR	0,00	NR	
Articolo	06085900	ADESIVO SISTEMA BYPASS PARTE AEREA L=30X50 MM		Si	1,00	0,00	NR	0,00	NR	
Articolo	06706500	ADESIVO ALLINEAMENTO CESTO (2 PEZZI) L=16X50+13(**)		Si	1,00	0,00	NR	0,00	NR	
Articolo	06998800	ADESIVO DEVIATORE POMPA MANUALE PIATTAFORMA GL17.80XL L=86X34 MM		Si	1,00	0,00	NR	0,00	NR	
Articolo	06713600	ADESIVO CONTROLLO MICRON STABILIZZATORI GIALLO_MOD_B		Si	4,00	0,00	NR	0,00	NR	
Articolo	1702155	ADESIVO JLG STACCABATTERIA L= 63,5X50,80 MM		Si	1,00	0,00	NR	0,00	NR	
Articolo	1701504	ADESIVO JLG OLIO IDRAULICO L=50,8x63,5 MM (**)		Si	1,00	0,00	NR	0,00	NR	
Articolo	06164700	ADESIVO FILTRO OLIO IDRAULICO BIANCO Ø50 MM		Si	1,00	0,00	NR	0,00	NR	
Articolo	06165000	ADESIVO LIVELLO OLIO IDRAULICO SFONDO BIANCO Ø50 MM		Si	1,00	0,00	NR	0,00	NR	
Articolo	07350300	ADESIVO SOLLEVAMENTO PIATTAFORMA CON MULETTO L=90X70 MM		Si	4,00	0,00	NR	0,00	NR	
Articolo	06254800	ADESIVO STOP EMERGENZA SFONDO GIALLO L=70X50 MM_MOD_B		Si	1,00	0,00	NR	0,00	NR	
Articolo	1608710001	ADESIVO PULSANTI DISTRIBUTORE A TERRA LATO SX GL17.80 L=194X50 MM_MOD_C		Si	1,00	0,00	NR	0,00	NR	
Articolo	1608710002	ADESIVO PULSANTI DISTRIBUTORE A TERRA LATO DX GL17.80 L=150X50 MM_MOD_C		Si	1,00	0,00	NR	0,00	NR	
Articolo	07668100	ADESIVO PULSANTI DISTRIBUTORE PARTE AEREA LL2614 L=318X52 MM		Si	1,00	0,00	NR	0,00	NR	
Articolo	06136900	ADESIVO PUNTI INGRASSAGGIO Ø 55 MM		Si	2,00	0,00	NR	0,00	NR	
Articolo	07240300	ADESIVO DISTANZA 1 METRO SU TELE/RADIO COMANDI L=75x35 MM_MOD_B		Si	1,00	0,00	NR	0,00	NR	

AGGIORNATO IL / UPDATED 31/08/2015

KIT ADESIVI COMMERCIALI PIATTAFORMA AEREA /
AERIAL PLATFORM KIT STICKERS COMMERCIAL
JLG/CE - X26JPLUS

Cod. 17633500

DA USARE CON / FOR USE WITH
17633400 KIT ADESIVI DI SICUREZZA PIATTAFORMA AEREA JLG/CE X26JPLUS /
STICKER KITS SAFETY AERIAL PLATFORM X26JPLUS

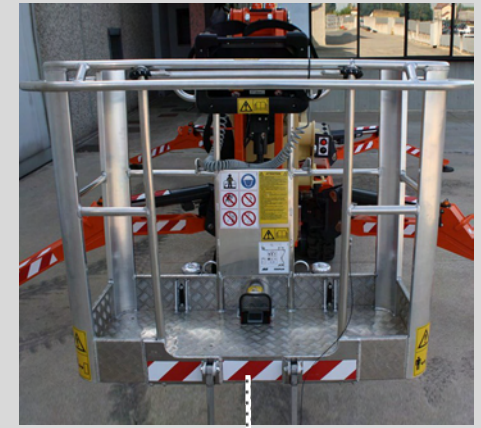
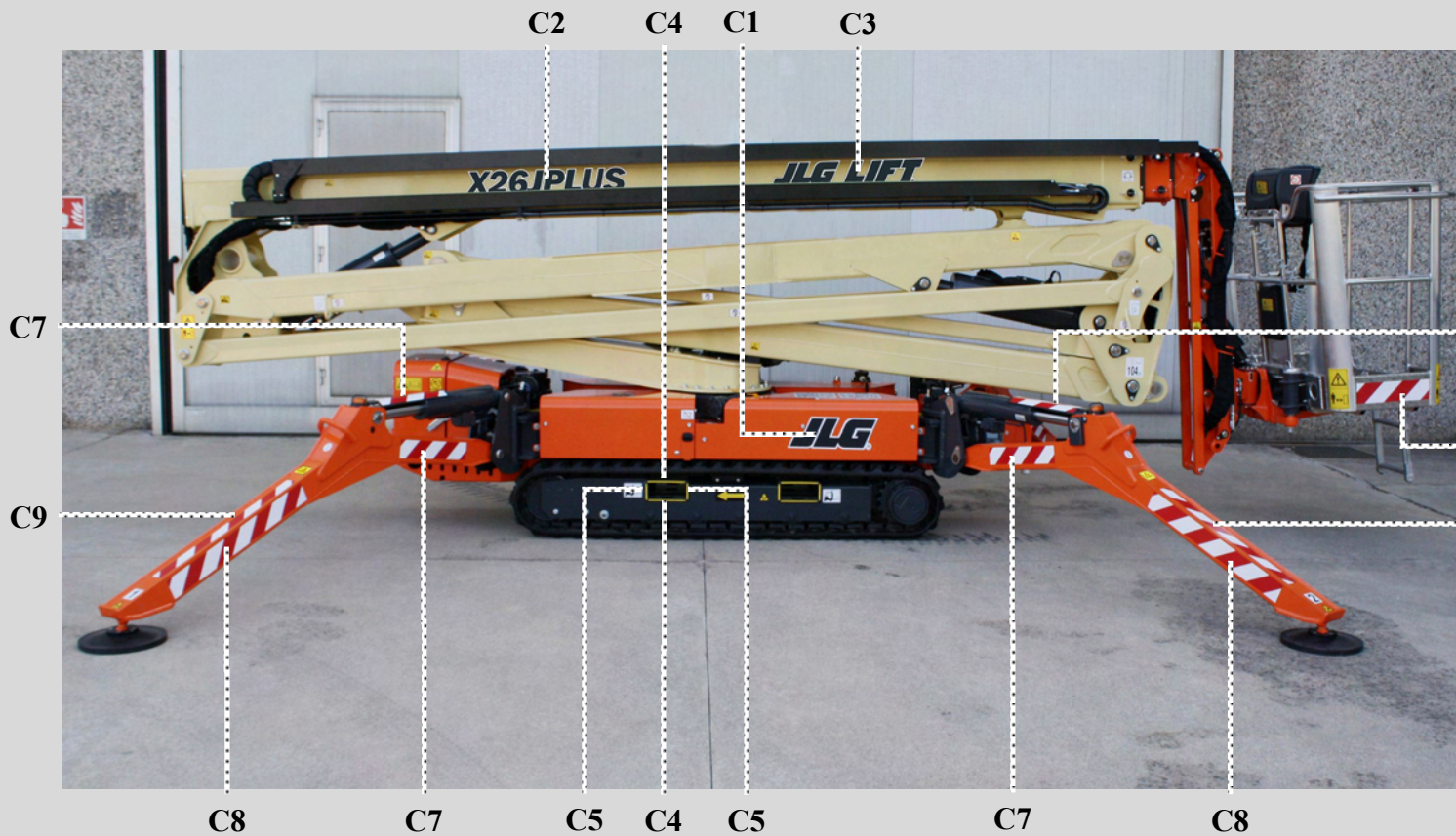

C8

C7

C5

C4

C5

C7

C8

C8

KIT ADESIVI - JLG/CE - X26JPLUS

SET OF DECALS - JLG/CE - X26JPLUS

KIT COLLANTS - JLG/CE - X26JPLUS

AUFKLEBERSATZ - JLG/CE - X26JPLUS

KIT ADHESIVOS - JLG/CE - X26JPLUS

ADHESIEKIT - JLG/CE - X26JPLUS

cod. 17633500

Ed. 31/08/2015

Tav 01

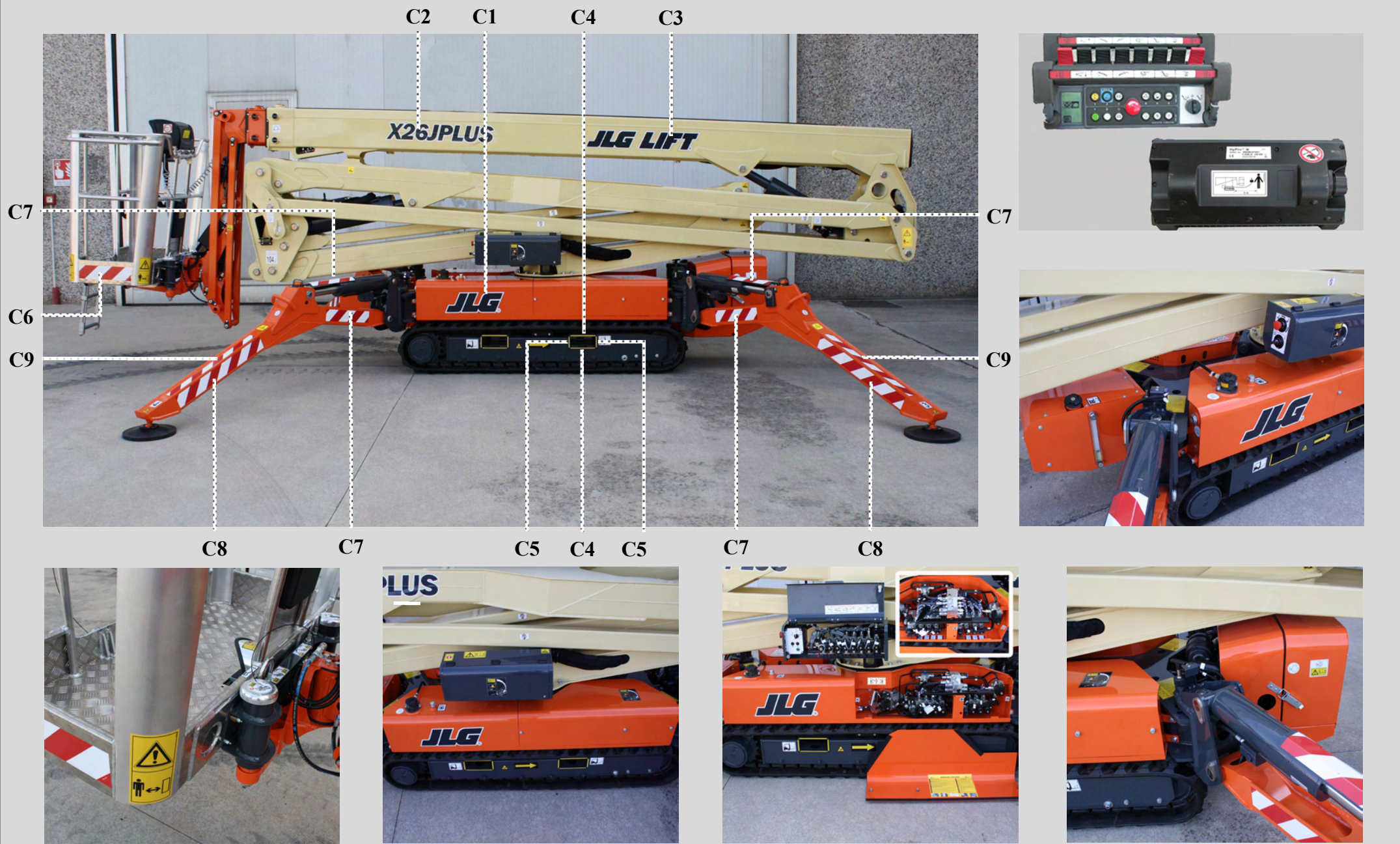

	KIT ADESIVI - JLG/CE - X26JPLUS	AUFKLEBERSATZ - JLG/CE - X26JPLUS	cod. 17633500	
	SET OF DECALS - JLG/CE - X26JPLUS	KIT ADHESIVOS - JLG/CE - X26JPLUS		
	KIT COLLANTS - JLG/CE - X26JPLUS	ADHESIEKIT - JLG/CE - X26JPLUS	Ed. 31/08/2015	Tav 02

KIT ADESIVI COMMERCIALI PIATTAFORMA AEREA /
AERIAL PLATFORM KIT STICKERS COMMERCIAL
JLG/CE - X26JPLUS

Cod. 17633500

COD. 17633500 POSIZIONE ADESIVI / POSITION STICKERS JLG / CE - X26JPLUS

Aggiornato il / Updated 31/08/2015

JLG

POS.	COD.	REV.	DESCRIZIONE / DESCRIPTION	Q.tà
C1	07060500	A	ADESIVO JLG LOGO JLG COLORE GRIGIO PANTONE 432C L=432x150MM	02
C2	07633800	A	ADESIVO JLG LOGO X26JPLUS COLORE GRIGIO PANTONE 432C L= 827X136 MM	02
C3	07677500	A	ADESIVO JLG LOGO JLG LIFT COLORE GRIGIO PANTONE 432C L=848X136 MM	02
C4	07268400	A	ADESIVO ATTENZIONE SOLLEVAMENTO FORCHE L=180X7 MM	08
C5	07268300	A	ADESIVO ATTENZIONE SOLLEVAMENTO FORCHE L=80X7 MM	08
C6	06086700	A	ADESIVO CON RIGHE BIANCHE E ROSSE L=430X100 MM	02
C7	06039900	A	ADESIVO CON RIGHE BIANCHE ROSSE L= 420 X 80 MM	12
C8	06039700	A	ADESIVO CON RIGHE BIANCHE ROSSE L= 700 X 80 MM	09
C9	06039600	A	ADESIVO CON RIGHE BIANCHE ROSSE L= 700 X 50	04
C10				
C11				
C12				
C13				
C14				
C15				
C16				
C17				
C18				
C19				
C20				
C21				
C22				
C23				

AGGIORNATO IL / UPDATED 30/05/2017

**KIT ADESIVI SICUREZZA PIATTAFORMA AEREA /
AERIAL PLATFORM KIT STICKERS SAFETY
JLG/ANSI - X770AJ**

Cod. 17633600

**+ kit in lingua non inclusi nel codice generale /
*+kit in language that is not included in the general***

176336GB - 176336FR - 176336ES - 176336PT

DA USARE CON / FOR USE WITH:

**17633700 KIT ADESIVI COMMERCIALI PIATTAFORMA AEREA JLG/ANSI - X770AJ
*STICKERS KIT COMMERCIAL AERIAL PLATFORM***

17107300 KIT ADESIVI INTEGRAZIONE PER PIATTAFORME JLG-ANSI LITIUM /

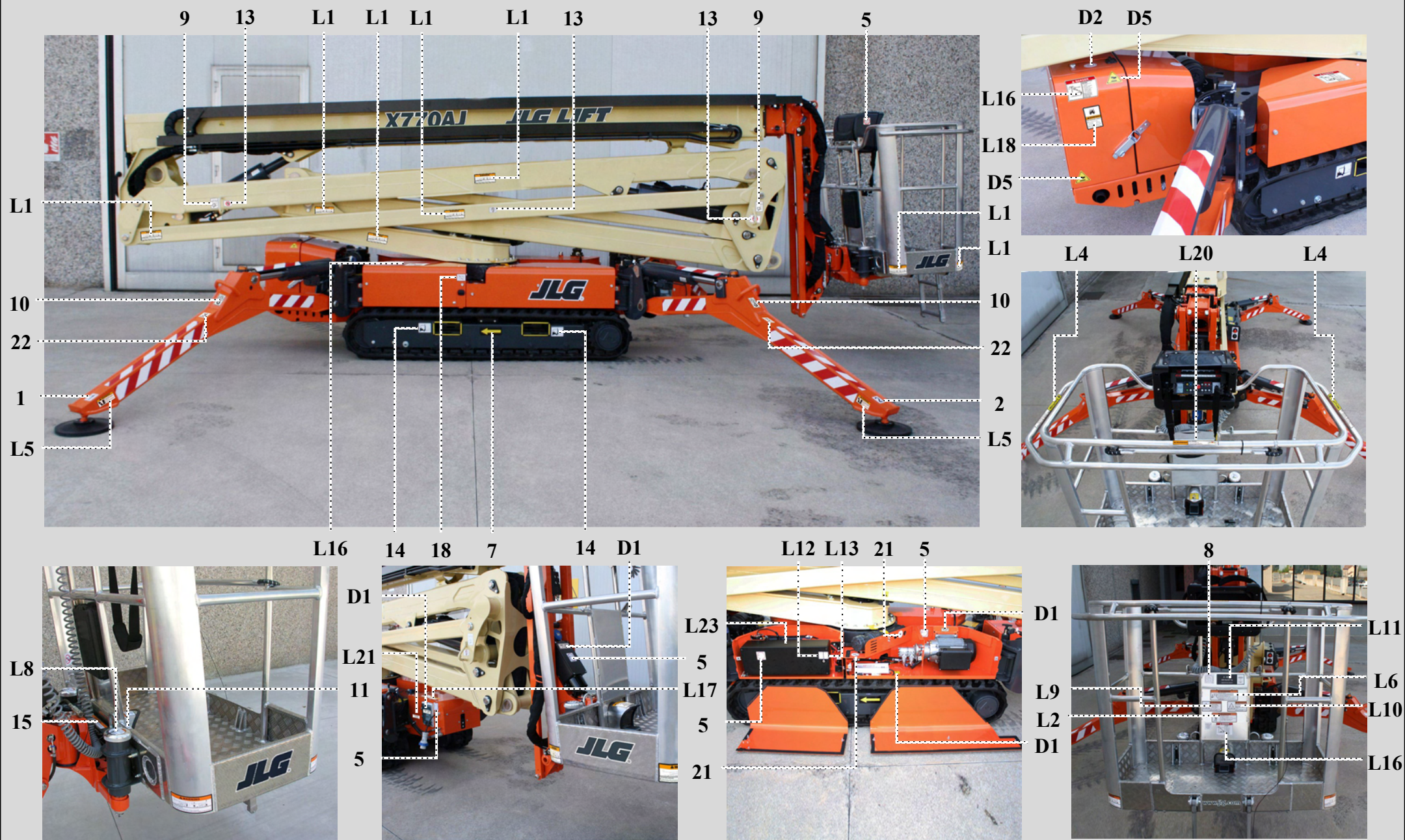

KIT ADESIVI - JLG/ANSI - X770AJ

SET OF DECALS - JLG/ANSI - X770AJ

KIT COLLANTS - JLG/ANSI - X770AJ

AUFKLEBERSATZ - JLG/ANSI - X770AJ

KIT ADHESIVOS - JLG/ANSI - X770AJ

ADHESIEKIT - JLG/ANSI - X770AJ

Cod. 17633600

Ed. 30/05/2017

Tav 01

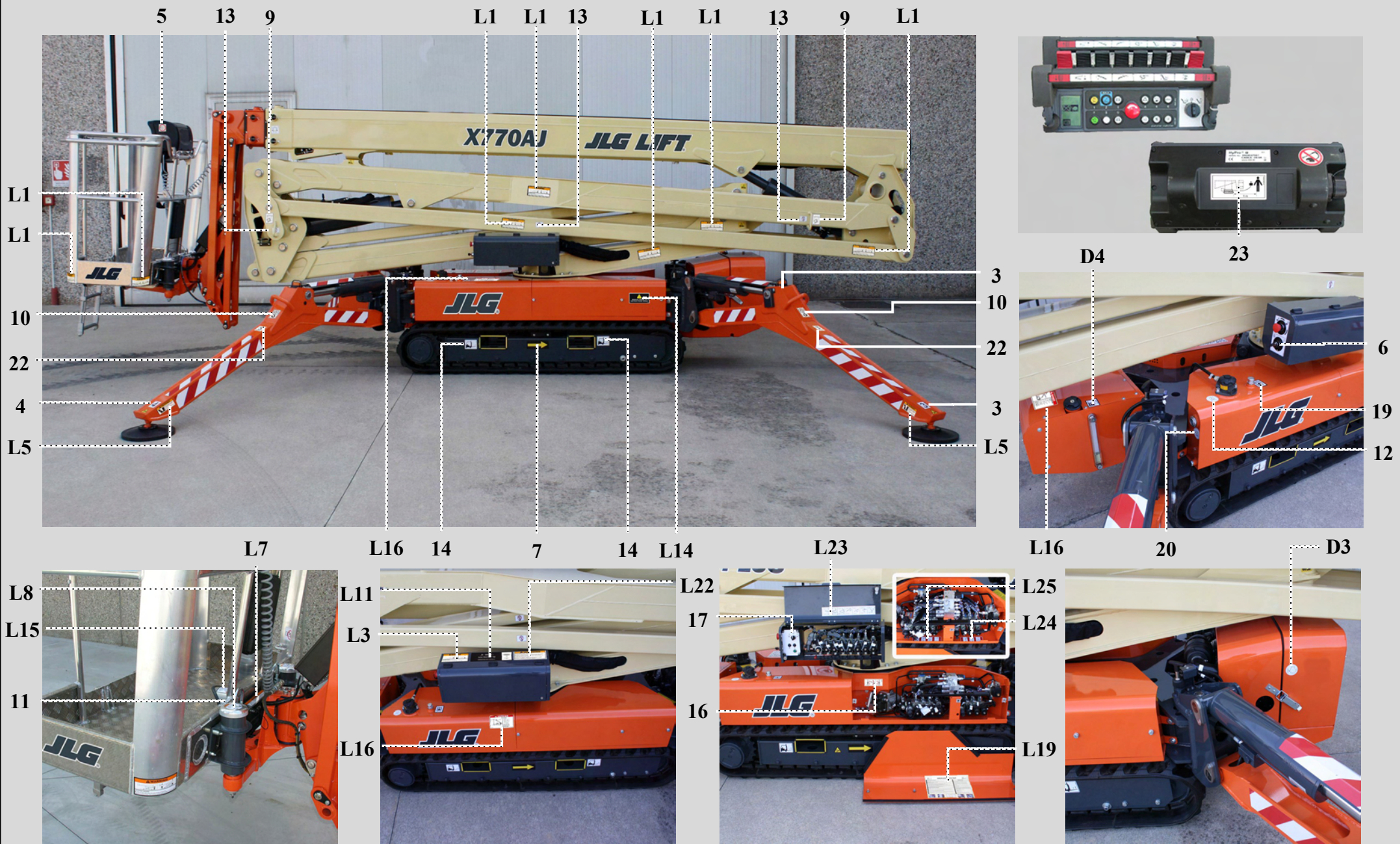

KIT ADESIVI - JLG/ANSI - X770AJ

SET OF DECALS - JLG/ANSI - X770AJ

KIT COLLANTS - JLG/ANSI - X770AJ

AUFKLEBERSATZ - JLG/ANSI - X770AJ

KIT ADHESIVOS - JLG/ANSI - X770AJ

ADHESIEKIT - JLG/ANSI - X770AJ

Cod. 17633600

Ed. 30/05/2017

Tav 02

L12 L13

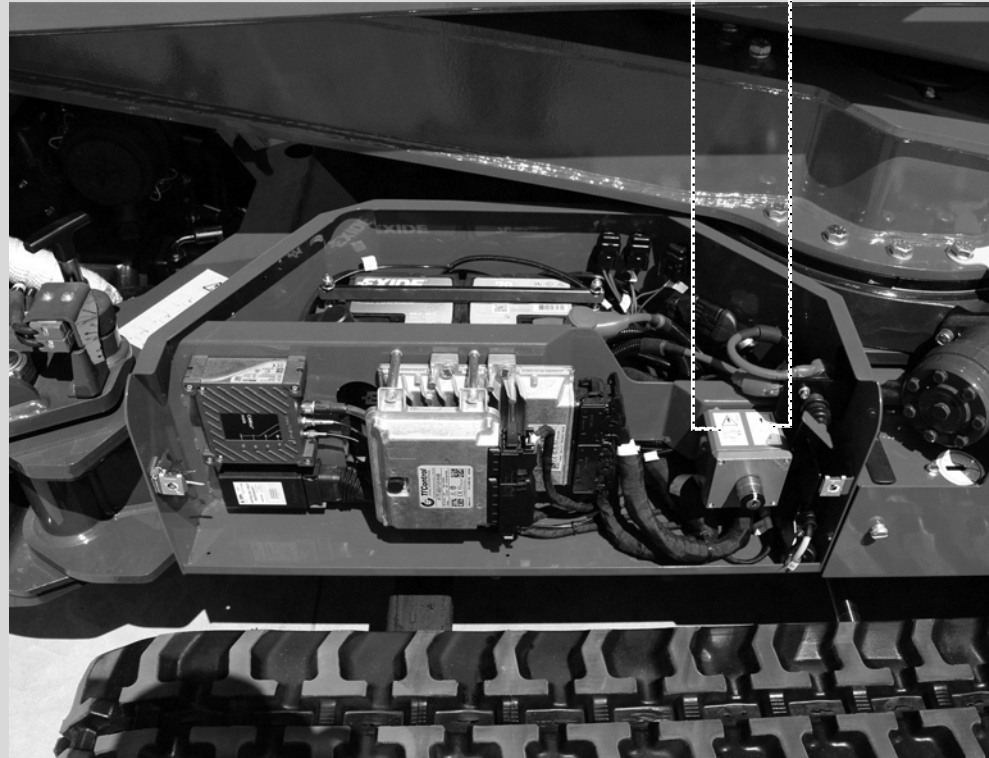

D1

5

D1



KIT ADESIVI - JLG/ANSI - X770AJ/200

AUFKLEBERSATZ - JLG/ANSI - X770AJ/200

SET OF DECALS - JLG/ANSI - X770AJ/200

KIT ADHESIVOS - JLG/ANSI - X770AJ/200

KIT COLLANTS - JLG/ANSI - X770AJ/200

ADHESIEKIT - JLG/ANSI - X770AJ/200

Cod. 17633600

Ed. 30/05/2017

Tav 03

JLG/ANSI X770AJ • COD. 17633600 POSIZIONE ADESIVI IN DISTINTA MACCHINA / ADHESIVE POSITION AT DISTINCT MACHINE

POSIZIONE	CODICE	REV.	ADESIVI IN DISTINTA MACCHINA / STICKERS IN LIST MACHINE	QUANTITA'
D1	07056300	A	ADESIVO JLG PERICOLO 220V - 50/60HZ L= 75X18,75 MM	05
	07056400	B	ADESIVO JLG PERICOLO 120V - 60HZ L= 75x32.68 MM MOD_B	05
D2	06214200	A	ADESIVO LIQUIDO REFRIGERANTE SFONDO BIANCO Ø 50 MM (**)	01
D3	06060000	A	ADESIVO LIVELLO OLIO MOTORE Ø50mm	01
D4	1701505	A	ADESIVO JLG CARBURANTE DIESEL L= 50,8X63,5	01
D5	06056300	A	ADESIVO PERICOLO SCOTTATURE L=60X51 TRIANGOLARE SFONDO GIALLO	02
D6				
D7				
D8				
D9				
D10				
D11				
D12				
D13				
D14				
D15				
D16				
D17				
D18				
D19				
D20				
D21				
D22				
D23				
D24				
D25				

JLG/ANSI X770AJ • COD. 17633600 POSIZIONE ADESIVI / POSITION STICKERS

JLG

POSIZIONE	CODICE	REV.	DESCRIZIONE	QUANTITA'
01	06555500	A	ADESIVO NR 1 L=50X60 BIANCO	01
02	06555600	A	ADESIVO NR 2 L=50X60 BIANCO	01
03	06555700	A	ADESIVO N° 3 L=50X60 BIANCO	01
04	06555800	A	ADESIVO N° 4 L=50X60 BIANCO	01
05	1001125483	A	ADESIVO JLG VIETATO LAVARE L=63,5X63,5 MM	06
06	07668200	B	ADESIVO EMERGENCY STOP E BLOCCHETTO ACCENSIONE L=85x160 MM MOD_B	01
07	06040500	A	ADESIVO DIREZ. TRASLAZIONE FRECCIA GIALLA SFONDO NERO L=61 X 160	02
08	1701640	A	ADESIVO JLG LEGGERE IL MANUALE L= 69,85x69,85 MM	01
09	1703814	A	ADESIVO JLG ATTACCO ANCORAGGIO L=55,56X76,2 MM	04
10	07071200	A	ADESIVO JLG PUNTO DI SOLLEVAMENTO L= 40X66 MM	04
11	1704277	A	ADESIVO JLG ATTACCO CINTURE DI SICUREZZA L= 76,2X19,05 MM	02
12	06164700	A	ADESIVO FILTRO OLIO IDRAULICO Ø50 MM BIANCO	01
13	07056700	A	ADESIVO JLG DIVIETO DI SOLLEVAMENTO L=40X54,88	06
14	07350300	A	ADESIVO SOLLEVAMENTO PIATTAFORMA CON MULETTO L=90X70 MM	04
15	06706500	A	ADESIVO ALLINEAMENTO CESTO (2 PEZZI) L=16X50+13	01
16	06998800	A	ADESIVO DEVIATORE POMPA MANUALE PIATTAFORMA GL17.80XL L=86X34	01
17	07668300	A	ADESIVO SELETTORE SCATOLA TERRA / CESTO L=105X155 MM	01
18	1702155	A	ADESIVO JLG STACCABATTERIA L= 63,5X50,80 MM	01
19	1701504	A	ADESIVO JLG OLIO IDRAULICO L=50,8x63,5 MM	01
20	06165000	A	ADESIVO LIVELLO OLIO IDRAULICO Ø50 SFONDO BIANCO	01
21	06136900	A	ADESIVO PUNTI DI INGRASSAGGIO Ø 55 mm	02
22	07678300	A	ADESIVO REAZIONE AL SUOLO STABILIZZATORI X770AJ COLORE BIANCO L= 50X50 MM	04
23	07240300	B	ADESIVO DISTANZA 1m SU TELE/RADIO COMANDI MOD_B	01
24				
25				
26				
27				

JLG/ANSI X7700AJ - COD. 176336** ADESIVI IN LINGUA / ADHESIVES IN LANGUAGE

JLG

POS.	CODICE				DESCRIZIONE	Q.TA'
	176336FR	176336PT	176336ES	176336GB		
					KIT ADESIVI SICUREZZA PIATTAFORMA AEREA JLG / ANSI X770AJ - LINGUA INGLESE	
L1	07116800	07121400		07056100	ADESIVO JLG PERICOLO SCHIACCIAMENTO - ING L= 140x60,71 MM	14
L2	07119100	07123700		1706387	ADESIVO JLG PERICOLO SCHIACCIAMENTO - ING L=177,80x69,85 MM (SUL CESTO)	01
L3	07118500	07123100		1706099	ADESIVO JLG PERICOLO SCHIACCIAMENTO - ING L= 161,925X69, 85 MM (A TERRA)	01
L4	07117800	07122400		1702868_B	ADESIVO JLG PERICOLO SCHIACCIAMENTO MANO - ING L= 241, 30X25.40 MM MOD_B	02
L5	07116900	07121500		07056200	ADESIVO JLG ATTACCO SCHIACCIAM. ARTO INFERIORE - ING L= 110x60 MM (PRES. STABILIZZ.)	08
L6	07119000	07123600		1706386	ADESIVO JLG PERICOLO CADUTE - ING L=196,85x76,2 MM	01
L7	07116700	07121300		07051100_B	ADESIVO JLG PERICOLO CADUTA - RIPRISTINARE I TAPPI - ING L= 196,5x35 MM MOD_B	01
L8	07116600	07121200		07051000	ADESIVO JLG ATTENZ.CADUTE - SBLOCCARE SOLO NEI CASI PREVISTI - ING D Ø 60 FORO 4 MM (**)	02
L9	07118700	07123300		1706133_C	ADESIVO JLG PERICOLO RIBALTAMENTO - ING L=139,7X68,85 MM MOD_C	01
L10	07117300	07121900		07058700	ADESIVO JLG POSIZIONE STABILIZZATORI X700 - ING L=139,7X68, 85 MM	01
L11	072423FR	072423PT		072423GB	ADESIVO JLG/ ANSI CARICO MAX IN CESTA X500AJ - ING L=196, 85x76,2 MM	02
L12	07115200	07119800		07042100	ADESIVO JLG SISTEMA BYPASS PARTE AEREA - ING L=30X50 (**)	01
L13	07115300	07119900		07042200	ADESIVO JLG SISTEMA BYPASS TRASLAZIONE - ING L= 30X50 (**)	01
L14	07117900	07122500		1702901	ADESIVO JLG ISTRUZIONI DISCESA EMERGENZA / POMPA MANUALE - ING L=114,3x58,73MM	01
L15	07119200	07123800		3252347_B	ADESIVO JLG ATTENZIONE PEDALE - ING L= 69,85x57,15 MM MOD_B	01
L16	07118600	07123200		1706128_E	ADESIVO JLG PERICOLO FOLGORAZIONE - ING L=120,65x91,50 MM MOD_E	05
L17	07118200	07122800		1703813	ADESIVO JLG PERICOLO ESPLOSIONE BATTERIE - ING L=149, 25X47,62 MM	01
L18	07118300	07122900		1704972_C	ADESIVO JLG PERICOLO ESPLOSIONE - ING L=63,5x92,07 MM MOD_C	01
L19	076791FR_B	076791PT_B		076791GB_B	ADESIVO JLG DISCESA DI EMERG. X770AJ MOTORE TERMICO E LITHIUM - ING L=290X205 MM_B	01
L20	07118900	07123500		1706385_C	ADESIVO JLG SCORRIMENTO SBARRA CHIUSURA CESTO - ING L= 184,15X25,4 MM MOD_C	01
L21	07118400	07123000		1705514	ADESIVO JLG CONFORMITA' CSA - ING L= 76,20x22,22 MM	01
L22	07118800	07123400		1706135_B	ADESIVO JLG USO PIATTAFORMA - ING L=139,70x88,90 MM MOD_B	01
L23	076787FR	076787PT		076787GB	ADESIVO JLG ANSI PULSANTI DISTRIBUTORE PARTE AEREA X770AJ - ING L=318X52 MM	01
L24	072425FR	072425PT		072425GB	ADESIVO JLG ANSI PULSANTI DISTRIBUTORI A TERRA LATO SX X500AJ - ING L=194X50 MM	01
L25	072426FR	072426PT		072426GB	ADESIVO JLG ANSI PULSANTI DISTRIBUTORI A TERRA LATO DX X500AJ - ING L=150X50 MM	01
L26						

AGGIORNATO IL / UPDATED 31/08/2015

KIT ADESIVI COMMERCIALI PIATTAFORMA AEREA /
STICKERS KIT COMMERCIAL AERIAL PLATFORM
JLG/ANSI - X770AJ

Cod. 17633700

DA USARE CON / FOR USE WITH

- **17633600 KIT ADESIVI SICUREZZA PIATTAFORMA AEREA / AERIAL PLATFORM SECURITY STICKERS KIT**
JLG / ANSI - X770AJ

C2 C10 C1 C3

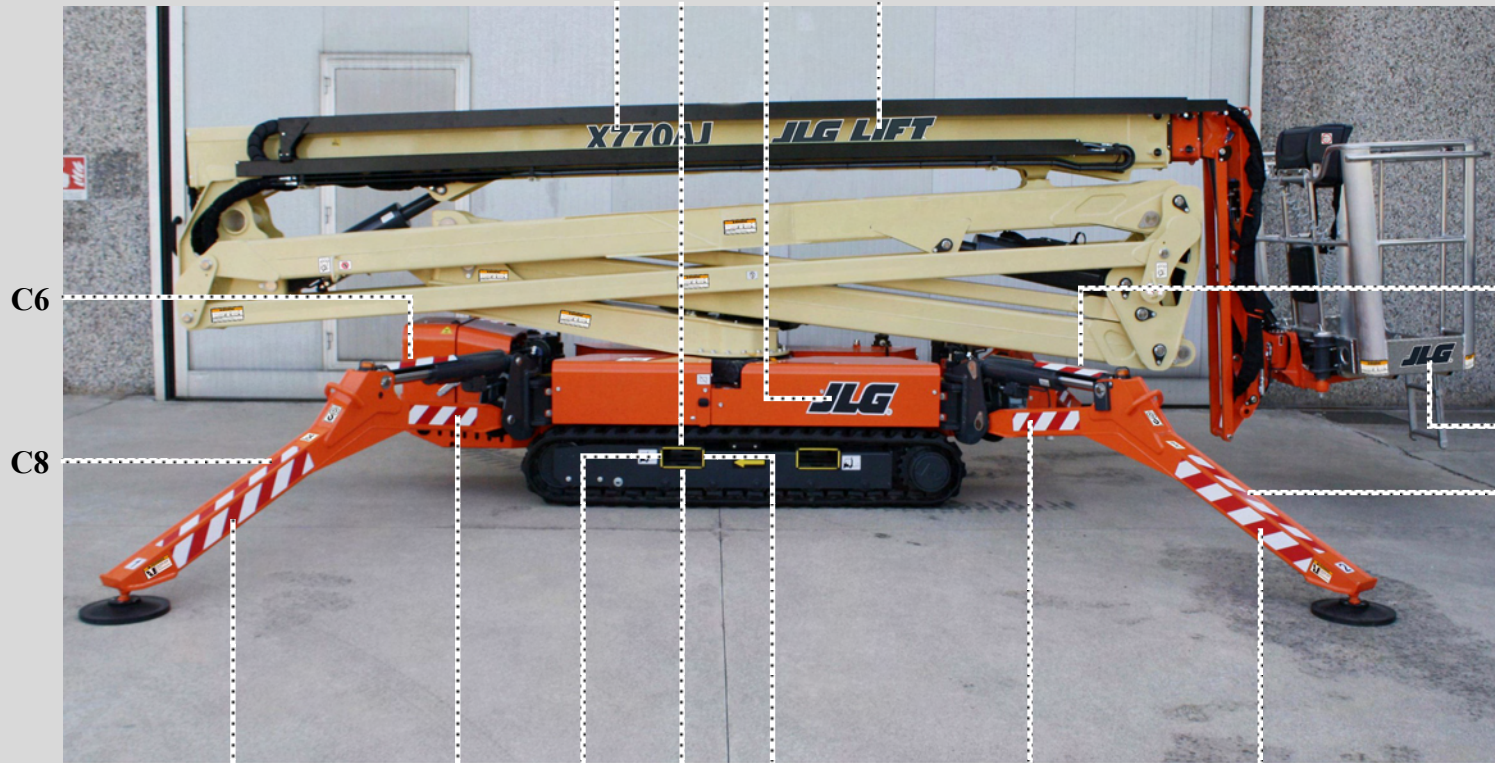

C6



C4

C8

C7 C6 C9 C10 C9 C6 C7



C5

KIT ADESIVI - JLG/ANSI - X770AJ
 SET OF DECALS - JLG/ANSI - X770AJ
 KIT COLLANTS - JLG/ANSI - X770AJ

AUFKLEBERSATZ - JLG/ANSI - X770AJ
 KIT ADHESIVOS - JLG/ANSI - X770AJ
 ADHESIEKIT - JLG/ANSI - X770AJ

Cod. 17633700

Ed. 31/08/2015 Tav 01

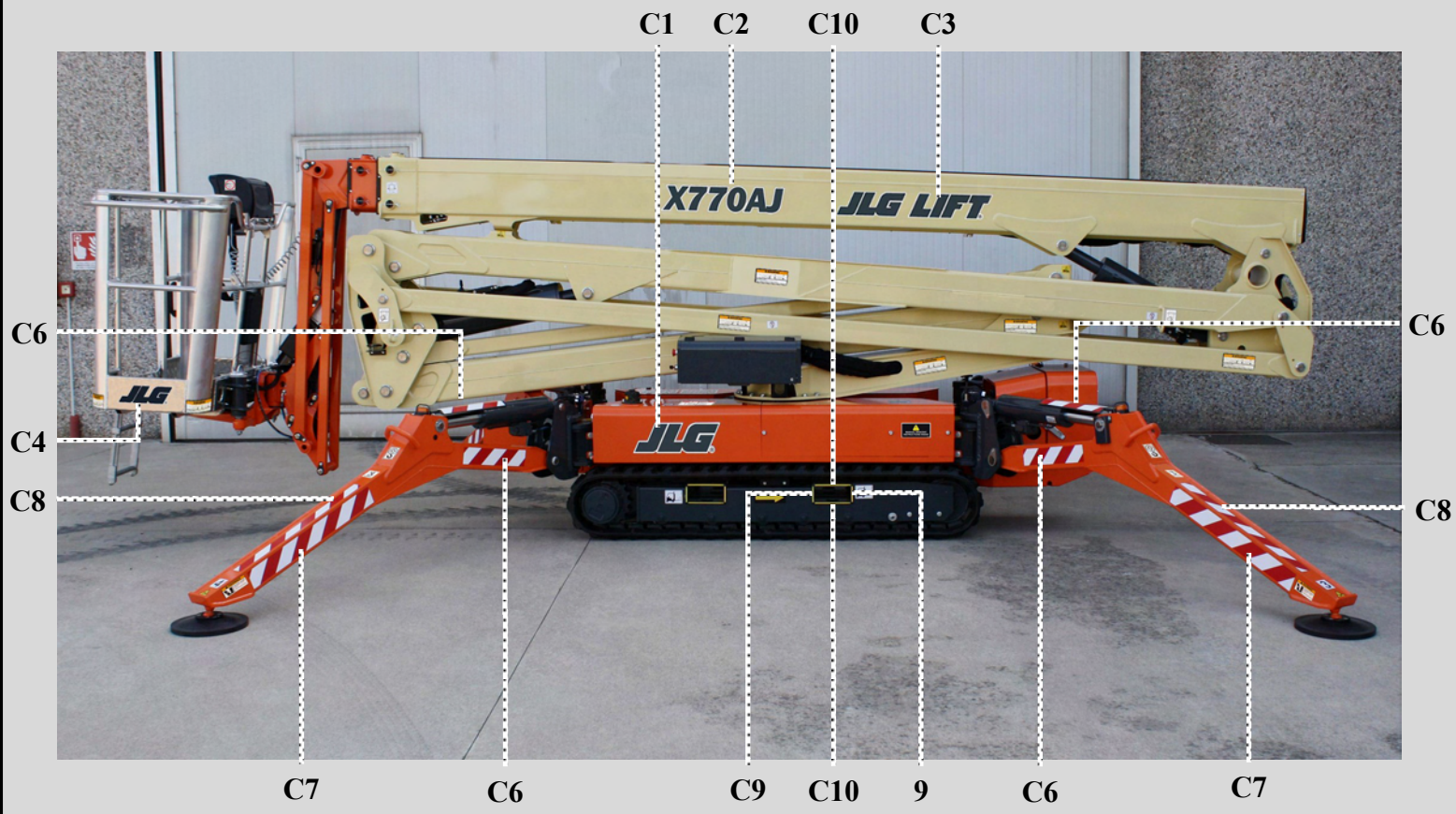

KIT ADESIVI - JLG/ANSI - X770AJ

SET OF DECALS - JLG/ANSI - X770AJ

KIT COLLANTS - JLG/ANSI - X770AJ

AUFKLEBERSATZ - JLG/ANSI - X770AJ

KIT ADHESIVOS - JLG/ANSI - X770AJ

ADHESIEKIT - JLG/ANSI - X770AJ

Cod. 17633700

Ed. 31/08/2015

Tav 02

KIT ADESIVI COMMERCIALI PIATTAFORMA AEREA /
STICKERS KIT COMMERCIAL AERIAL PLATFORM
JLG/ANSI - X770AJ

Cod. 17633700

COD. 17633700 POSIZIONE ADESIVI / POSITION STICKERS

Aggiornato il / Updated 31/08/2015

JLG

POS.	COD.	REV.	DESCRIZIONE / DESCRIPTION	Q.tà
C1	07060500	A	ADESIVO JLG LOGO JLG COLORE GRIGIO PANTONE 432C L=432x150MM (**)	02
C2	07633900	A	ADESIVO JLG LOGO X770AJ COLORE GRIGIO PANTONE 432C L=623X136 MM	02
C3	07677500	A	ADESIVO JLG LOGO JLG LIFT COLORE GRIGIO PANTONE 432C L=848X136 MM	02
C4	07690100	A	ADESIVO JLG - LOGO JLG PER CESTO COLORE GRIGIO PANTONE 432C L=300x104,2 MM	02
C5	07691500	A	ADESIVO LOGO WWW.JLG.COM COLORE PANTONE 432C L=200X33 MM	01
C6	06039900	A	ADESIVO CON RIGHE BIANCHE ROSSE L= 420 X 80 MM	12
C7	06039700	A	ADESIVO CON RIGHE BIANCHE ROSSE L= 700 X 80 MM	08
C8	06039600	A	ADESIVO CON RIGHE BIANCHE ROSSE L= 700 X 50	04
C9	07268300	A	ADESIVO ATTENZIONE SOLLEVAMENTO FORCHE L=80X7 MM	08
C10	07268400	A	ADESIVO ATTENZIONE SOLLEVAMENTO FORCHE L=180X7 MM	08
C11				
C12				
C13				
C14				
C15				
C16				
C17				
C18				
C19				
C20				
C21				
C22				
C23				
C24				

TABELLA PERNI/SPINE (PINS TABLE)

LOCKING SYSTEM
GHIERA
(LOCKNUTS CODE)
REF. TABLE BELOW

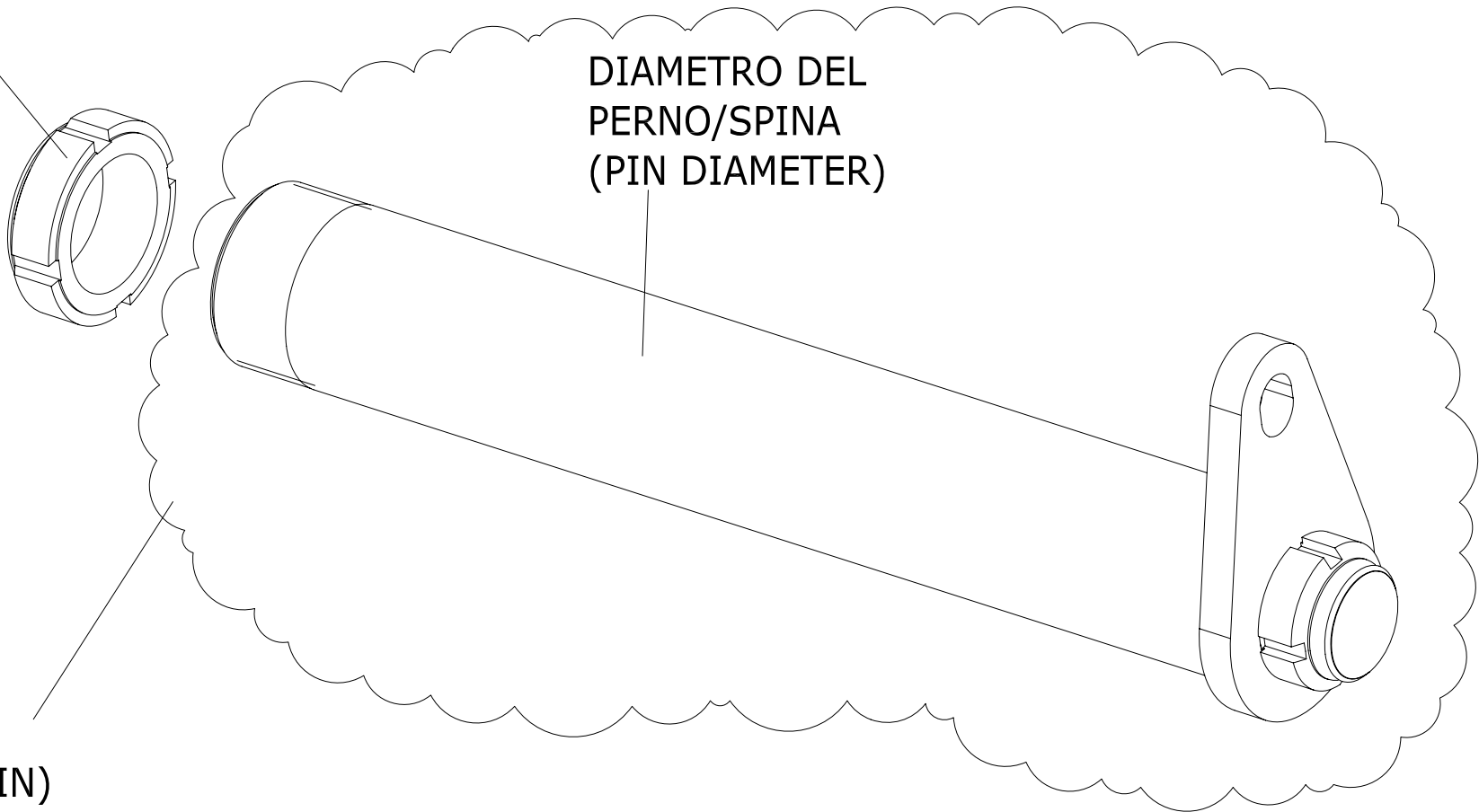

PERNO/SPINA (PIN)



IL CODICE DEL PERNO A RICAMBIO COMPRENDE LA GOCCIA MONTATA E LA GHIERA DI FISSAGGIO DELLA GOCCIA



THE CODE OF A PIN INCLUDES DROP PARTS MOUNTED AND THE LOCK NUT TO FIXING THE DROP, ALL THESE PARTS ARE SHIPPED ALREADY MOUNTED TOGETHER

DIAMETRO DEL PERNO/SPINA mm SISTEMA METRICO (PIN DIAMETER mm METRIC)	GHIERA (LOCKNUTS CODE)	DADO (NUTS CODE)
25	BG4	
30	BG5	
35	BG3	
40	BG2	
45	BG7	
50	BG8	
20 (DIAMETER OF THREADED PART M17 PITCH=1)	BG1	
20 (DIAMETER OF THREADED PART M20 PITCH=1)	BG6	
20 (DIAMETER OF THREADED PART M20 PITCH=1,5)	BG12	



POS	Codice	U.M.	 Descrizione	 Description
BC1	BC000100	NR	COPPIGLIA 4X40	COTTER PIN 4x40
BC2	BC000200	NR	COPPIGLIA 5X40	COTTER PIN 5x40
BC3	BC000300	NR	SEEGER ESTERNO Ø20 GEOMET	SEEGER EXTERNAL Ø20 GEOMET
BC4	BC000400	NR	SEEGER ESTERNO Ø8	SEEGER EXTERNAL Ø8
BC5	BC000500	NR	SEEGER ESTERNO Ø25 GEOMET	SEEGER EXTERNAL Ø25 GEOMET
BC6	BC000600	NR	COPPIGLIA 1,8X8	COTTER PIN 1,8X8
BC7	BC000700	NR	COPPIGLIA 4X55	COTTER PIN 4x55
BC8	BC000800	NR	SEEGER ESTERNO Ø15	SEEGER EXTERNAL Ø15
BC9	BC000900	NR	SEEGER ESTERNO Ø30	SEEGER EXTERNAL Ø30
BD1	BD000100	NR	Dado Esagonale Flangiato Liscio PG DIN 6923 CI 8 M 14 Z.Bianca	Hex Flange Nut DIN 6923 CI Smooth PG 8 M 14 Z. white
BD2	BD000200	NR	Dado Esagonale Basso PG DIN 936 CI 04 M 8 Z.Bianca	Low Hex nut DIN 936 PG 04 M CI 8 Z. white
BD3	BD000300	NR	Dado Esagonale Alto PG UNI 5587 CI 8 M 8 Z.Bianca	Hex Nut High PG UNI 5587 CI 8 M 8 Z. white
BD4	BD000400	NR	Dado Alto Autobloccante PG DIN 982 CI 8 M 12 Z.Bianca	High Self Locking Nut DIN 982 PG 12 CI 8 M Z. white
BD5	BD000500	NR	Dado Alto Autobloccante PG DIN 982 CI 8 M 8 Z.Bianca	High Self Locking Nut DIN 982 PG CI 8 M 8 Z. white
BD6	BD000600	NR	Dado Esagonale Alto PG UNI 5587 CI 8 M 4 Z.Bianca	Hex Nut High PG UNI 5587 M 4 CI 8 Z. white
BD7	BD000700	NR	Dado Esagonale Basso PG DIN 936 CI 04 M 6 Z.Bianca	Low Hex nut DIN 936 PG 6 CI 04 M Z. white
BD8	BD000800	NR	Dado Basso Autobloccante PG DIN 985 CI 8 M 6 Z.Bianca	Low Self-locking nut DIN 985 PG 6 CI 8 M Z. white
BD9	BD000900	NR	Dado Alto Autobloccante PG DIN 982 CI 8 M 6 Z.Bianca	High Self Locking Nut DIN 982 PG CI 8 M6 Z. white

POS	Codice	U.M.	 Descrizione	 Description
BD10	BD001000	NR	Dado Basso Autobloccante PG DIN 985 CI 8 M 5 Z.Bianca	Low Self-locking nut DIN 985 PG CI 8 M5 Z. white
BD11	BD001100	NR	Dado Alto Autobloccante PG DIN 982 CI 8 M 5 Z.Bianca	High Self Locking Nut DIN 982 PG CI 8 M5 Z. white
BD12	BD001200	NR	Dado Alto Autobloccante PG DIN 982 CI 8 M 4 Z.Bianca	High Self Locking Nut DIN 982 PG CI 8 M4 Z. white
BD13	BD001300	NR	Dado Alto Autobloccante PG DIN 982 CI 8 M 3 Z.Bianca	High Self Locking Nut DIN 982 PG CI 8 M3 Z. white
BD14	BD001400	NR	Dado Alto Autobloccante PF DIN 982 CI 8 M 20 x 1,5 Z.Bianca	High Self Locking Nut DIN 982 PF CI 8 M 20 x 1.5 Z white
BD15	BD001500	NR	Dado Alto Autobloccante PG DIN 982 CI 8 M 10 Z.Bianca	High Self Locking Nut DIN 982 PG CI 8 M10 Z. white
BD16	BD001600	NR	Dado Esagonale Alto PG UNI 5587 CI 8 M 3 Z.Bianca	Hex Nut High PG UNI 5587 CI 8 M3 Z. white
BD17	BD001700	NR	Dado Basso Autobloccante PG DIN 985 CI 8 M 8 Z.Bianca	Low Self-locking nut DIN 985 PG CI 8 M8 Z. white
BD18	BD001800	NR	Dado Alto Autobloccante PG DIN 982 CI 8 M 16 Z.Bianca	High Self Locking Nut DIN 982 PG CI 8 M16 Z. white
BD22	BD002200	NR	Dado Alto Autobloccante PG DIN 982 CI 8 M 14 Z.Bianca	Hex Flange Nut DIN 982 CI 8 M 14 Z. white
BD23	BD002300	NR	Dado Basso Autobloccante PG DIN 985 CI 8 M 10 Z.Bianca	Low Self-locking nut DIN 985 PG CI 8 M 10 Z. white
BD24	BD002400	NR	Dado Alto Autobloccante PG DIN 982 CI 8 M 24 Z.Bianca	High Self Locking Nut DIN 982 PG CI 8 M24 Z. white
BD25	BD002500	NR	Dado Esagonale Alto PG UNI 5587 CI 8 M 6 Z.Bianca	Hex Nut High PG UNI 5587 M 6 CI 8 Z. white
BD26	BD002600	NR	Dado Esagonale Alto PG UNI 5587 CI 10 M 10 Z.Bianca	Hex Nut High PG UNI 5587 M 10 CI 10 Z. white
BD27	BD002700	NR	Dado Alto Autobloccante PG DIN 982 CI 8 M 18 Z.Bianca	High Self Locking Nut DIN 982 PG CI 8 M18 Z. white
BD28	BD002800	NR	Dado Basso Autobloccante PG DIN 985 CI 8 M 16 Z.Bianca	Low Self-locking nut DIN 985 PG CI 8 M 16 Z. white
BD29	BD002900	NR	Dado Esagonale Alto PG UNI 5587 CI 8 M 5 Z.Bianca	Hex Nut High PG UNI 5587 M 5 CI 8 Z. white
BD30	BD003000	NR	Dado Esagonale Alto PG UNI 5587 CI 12 M 5 Z.Bianca	Hex Nut High PG UNI 5587 M 5 CI 12 Z. white

POS	Codice	U.M.	 Descrizione	 Description
BD31	BD003100	NR	Dado Esagonale Alto PG UNI 5587 CI 16 M 5 Z.Bianca	Hex Nut High PG UNI 5587 M 5 CI 16 Z. white
BD32	BD003200	NR	Dado Alto Autobloccante PG DIN 982 CI 8 M 20 Z.Bianca	High Self Locking Nut DIN 982 PG CI 8 M20 Z. white
BD33	BD003300	NR	Dado Basso Autobloccante PG DIN 985 CI 8 M 12 Z.Bianca	Low Self-locking nut DIN 985 PG CI 8 M 12 Z. white
BG1	BG000100	NR	Ghiera autobloccante GN CI 6 GN 3 D. 17 x 1 Z.Bianca	Self-locking nut GN GN 3 CI 6 D. 17 x 1 Z. white
BG2	BG000200	NR	Ghiera autobloccante pesante CI 6 GUP 40 x 1,5 Z.Bianca	Self-locking nut heavy CI 6 GUP 40 x 1.5 Z white
BG3	BG000300	NR	Ghiera autobloccante pesante CI 6 GUP 35 x 1,5 Z.Bianca	Self-locking nut heavy CI 6 GUP 35 x 1.5 Z white
BG4	BG000400	NR	Ghiera autobloccante pesante CI 6 GUP 25 x 1,5 Z.Bianca	Self-locking nut heavy CI 6 GUP 25 x 1.5 Z white
BG5	BG000500	NR	Ghiera autobloccante pesante CI 6 GUP 30 x 1,5 Z.Bianca	Self-locking nut heavy CI 6 GUP 30 x 1.5 Z white
BG6	BG000600	NR	Ghiera autobloccante pesante CI 6 GUP 20 x 1 Z.Bianca	Self-locking nut heavy CI 6 GUP 20 x 1 Z. white
BG7	BG000700	NR	Ghiera autobloccante GN CI 6 GN 3 D. 45 x 1,5 Z.Bianca	NUT
BG8	BG000800	NR	Ghiera autobloccante GN CI 6 GN 3 D. 50 x 1,5 Z.Bianca	NUT
BG9	BG000900	NR	Ghiera autobloccante GN CI 6 GN 3 D. 20 x 1,5 Z.Bianca	NUT
BG10	BG001000	NR	Ghiera autobloccante ribassata CI 6 GUK 25 x 1,5 Z.Bianca	Self-locking nut lowered CI 6 GUK 25 x 1.5 Z.Bianca
BG11	BG001100	NR	Ghiera autobloccante ribassata CI 6 GUK 20 x 1 Z.Bianca	Self-locking nut lowered CI 6 GUK 20 x 1 Z.Bianca
BG12	BG001200	NR	Ghiera autobloccante ribassata CI 6 GUA 20 x 1.5 Z.Bianca	Self-locking nut lowered CI 6 GUA 20 x 1.5 Z.Bianca
BG13	BG001300	NR	Ghiera autobloccante ribassata CI 6 GUK 30 x 1.5 Z.Bianca	Self-locking nut lowered CI 6 GUK 30 x 1.5 Z.Bianca
BG14	BG001400	NR	Ghiera autobloccante ribassata CI 6 GUK 45 x 1.5 Z.Bianca	Self-locking nut lowered CI 6 GUK 45 x 1.5 Z.Bianca
BG15	BG001500	NR	Ghiera autobloccante ribassata CI 6 GUK 50 x 1.5 Z.Bianca	Self-locking nut lowered CI 6 GUK 50 x 1.5 Z.Bianca

POS	Codice	U.M.	 Descrizione	 Description
BG16	BG001600	NR	Ghiera autobloccante ribassata CI 6 GUK 55 x 1.5 Z.Bianca	Self-locking nut lowered CI 6 GUK 55 x 1.5 Z.Bianca
BI1	BI000100	NR	INSERTO ESAGONALE M6	INSERT HEX M6
BI2	BI000200	NR	INSERTO ESAGONALE M5	INSERT HEX M5
BI3	BI000300	NR	INSERTO CILINDRICO M4	INSERT M4
BI4	BI000400	NR	INSERTO CILINDRICO M6	INSERT M6
BI5	BI000500	NR	INSERTO ESAGONALE M8	INSERT HEX M8
BI6	BI000600	NR	INSERTO ESAGONALE M4	INSERT HEX M4
BR1	BR000100	NR	Grower sez.rett.spigoli vivi pesante UNI 9195 Acc.Molle D 6 Z.D.Bianca	Grower sez.rett. sharp heavy UNI 9195 Acc.Molle D 6 Z.D. white
BR2	BR000200	NR	Rondella Piana DIN 125-A HV100 D 4 Z.Bianca	Plain washer DIN 125-A HV100 D 4 Z. white
BR3	BR000300	NR	Rondella Piana DIN 125-A HV100 D 5 Z.Bianca	Plain washer DIN 125-A HV100 D 5 Z. white
BR4	BR000400	NR	Rondella Piana DIN 125-A HV100 D 6 Z.Bianca	Plain washer DIN 125-A HV100 D 6 Z. white
BR5	BR000500	NR	Rondella Piana DIN 125-A HV100 D 8 Z.Bianca	Plain washer DIN 125-A HV100 D 8 Z. white
BR6	BR000600	NR	Rondella Piana DIN 125-A HV100 D 10 Z.Bianca	Plain washer DIN 125-A HV100 D 10 Z. white
BR7	BR000700	NR	Rondella Piana DIN 125-A HV100 D 12 Z.Bianca	Plain washer DIN 125-A HV100 D 12 Z. white
BR8	BR000800	NR	Rosetta piana fascia larga e=3d DIN 9021 HV100 D 10 x 30 x 2,5 Z.Bianca	Wide band and flat washer DIN 9021 HV100 3d = D 10 x 30 x 2.5 Z white
BR9	BR000900	NR	Rosetta piana fascia larga e=3d DIN 9021 HV100 D 12 x 36 x 2,5 Z.Bianca	Wide band and flat washer DIN 9021 HV100 3d = D 12 x 36 x 2.5 Z white
BR10	BR001000	NR	Rondella x Carpenteria DIN 6916 HV 300 D 16 Z.Bianca	Carpentry washer DIN 6916 HV 300 D 16 Z white



POS	Codice	U.M.	 Descrizione	 Description
BR11	BR001100	NR	Rosette speciali HV100 D 25 x 51 x 1 Z.Bianca	Special washers HV100 D 25 x 51 x 1 Z. white
BR13	BR001300	NR	Rondella dentellatura esterna DIN 6798-A Acc.Molle D 3 Z.D.Bianca	Washer external serration DIN 6798-A Acc.Molle D 3 ZD white
BR14	BR001400	NR	Rosetta piana fascia larga e=3d DIN 9021 HV100 D 5 x 15 x 1,2 Z.Bianca	Wide band and flat washer DIN 9021 HV100 3d = D 5 x 15 x 1.2 Z whit
BR15	BR001500	NR	Rosetta piana fascia larga e=3d DIN 9021 HV100 D 6 x 18 x 1,5 Z.Bianca	Wide band and flat washer DIN 9021 HV100 3d = D 6 x 18 x 1.5 Z white
BR16	BR001600	NR	Rosetta piana fascia larga e=3d DIN 9021 HV100 D 8 x 24 x 2 Z.Bianca	Wide band and flat washer DIN 9021 HV100 3d = D 8 x 24 x 2 Z. white
BR17	BR001700	NR	Rosetta piana fascia larga e=3d DIN 9021 HV100 D 4 x 12 x 1 Z.Bianca	Wide band and flat washer DIN 9021 HV100 D = 3d 4 x 12 x 1 Z. white
BR18	BR001800	NR	Rondella Piana DIN 125-A NYLON D 4	Plain washer DIN 125-A NYLON D 4
BR19	BR001900	NR	Rondella Piana DIN 125-A HV100 D 3 Z.Bianca	Plain washer DIN 125-A HV100 D 3 Z. white
BR20	BR002000	NR	Rondella Piana DIN 125-A HV100 D 16 Z.Bianca	Plain washer DIN 125-A HV100 D 16 Z. white
BR21	BR002100	NR	Rosetta piana fascia larga e=3d DIN 9021 HV100 D 16 x 48 x 4 Z.Bianca	Wide band and flat washer DIN 9021 HV100 3d = D 16 x 48 x 4 Z. white
BR22	BR002200	NR	Grower sez.rett.spigoli vivi pesante UNI 9195 Acc.Molle D 8 Z.D.Bianca	Grower section. rect. sharp heavy UNI 9195 Stainless Springs D 8 Z.D. white
BR23	BR002300	NR	Rosetta piana fascia larga e=3d DIN 9021 HV100 D 3 x 12 x 1 Z.Bianca	Wide band and flat washer DIN 9021 HV100 D = 3d 3 x 12 x 1 Z. white
BR24	BR002400	NR	Rosetta piana fascia larga e=3d DIN 9021 HV100 D 14 x 42 x 3 Z.Bianca	Wide band and flat washer DIN 9021 HV100 D = 3d 14 x 42 x 3 Z. white
BR25	BR002500	NR	Grower sez.rett.spigoli vivi pesante UNI 9195 Acc.Molle D 10 Z.D.Bianca	Grower sez.rett. sharp heavy UNI 9195 Acc.Molle D 10 Z.D. white
BR26	BR002600	NR	Rondella Piana DIN 125-A D 30 Z.Bianca	Plain washer DIN 125-A D 30 Z. white
BR27	BR002700	NR	Rondella Piana DIN 125-A HV100 D 14 Z.Bianca	Plain washer DIN 125-A HV100 D 14 Z. white



POS	Codice	U.M.	 Descrizione	 Description
BR28	BR002800	NR	Rosetta piana fascia larga D 6 x 24 x 2 Z.Bianca	Wide band and flat washer D 6 x 24 x 2 Z white
BR29	BR002900	NR	Rondella Piana DIN 125-A HV100 D 18 Z.Bianca	Plain washer DIN 125-A HV100 D 18 Z. white
BR30	BR003000	NR	Rondella Piana DIN 125-A HV100 D 20 Z.Bianca	Plain washer DIN 125-A HV100 D 20 Z. white
BR31	BR003100	NR	Grower sez.rett.spigoli vivi pesante UNI 9195 Acc.Molle D 12 Z.D.Bianca	Grower sez.rett. sharp heavy UNI 9195 Acc.Molle D 12 Z.D. white
BR32	BR003200	NR	Rosette speciali HV100 D 30 x 42 x 0.5 Z.Bianca	Special washers HV100 D 30 x 42 x 0.5 Z. white
BR33	BR003300	NR	Rosette speciali HV100 D 30 x 61 x 1 Z.Bianca	Special washers HV100 D 30 x 61 x 1 Z. white
BR34	BR003400	NR	Rosette speciali HV100 D 42 x 52 x 0.2 Z.Bianca	Special washers HV100 D 42 x 52 x 0.2 Z. white
BR35	BR003500	NR	Rosette speciali HV100 D 42 x 52 x 0.3 Z.Bianca	Special washers HV100 D 42 x 52 x 0.3 Z. white
BR36	BR003600	NR	Rosette speciali HV100 D 42 x 52 x 1 Z.Bianca	Special washers HV100 D 42 x 52 x 1 Z. white
BR37	BR003700	NR	Rosette speciali HV100 D 42 x 52 x 1.5 Z.Bianca	Special washers HV100 D 42 x 52 x 1.5 Z. white
BR38	BR003800	NR	Rosette speciali HV100 D 42 x 52 x 2 Z.Bianca	Special washers HV100 D 42 x 52 x 2 Z. white
BR39	BR003900	NR	Rosetta piana fascia larga e=3d DIN 9021 HV100 D 18 x 48 x 4 Z.Bianca	Wide band and flat washer DIN 9021 HV100 3d = D 18 x 48 x 4 Z. white
BR40	BR004000	NR	Rosetta SCHNORR zincate D 6	WASHER
BR41	BR004100	NR	Grower sez.rett.spigoli vivi pesante UNI 9195 Acc.Molle D 14 Z.D.Bianca	Grower sez.rett. sharp heavy UNI 9195 Acc.Molle D 14 Z.D. white
BR42	BR004200	NR	Rondella x Carpenteria DIN 6916 HV 300 D 14 Z.Bianca	Carpentry washer DIN 6916 HV 300 D 14 Z white
BR43	BR004300	NR	Rondella x Carpenteria DIN 125-A HV 300 D 10 Z.Bianca	Carpentry washer DIN 125-A HV 300 D 10 Z white
BR44	BR004400	NR	Rondella x Carpenteria DIN 125-A HV 300 D 20 Z.Bianca	Carpentry washer DIN 125-A HV 300 D 20 Z white

POS	Codice	U.M.	 Descrizione	 Description
BS1	BS000100	NR	GRANO FILETTATO M6X12	SCREW
BS2	BS000200	NR	SPINA CIL. 8x16 UNI 6364-A h6 CMT + TMP	PIN CYLINDER 8 x 16 UNI 6364-A CMT h6 + TMP
BS3	BS000300	NR	PRIGIONIERO M10X35	PIN
BS4	BS000400	NR	SPINA ELASTICA 6X60 UNI 6873	PIN
BS5	BS000500	NR	SPINA ELASTICA 6X14 UNI 6873	PIN
BS6	BS000600	NR	Spina Spirol Normale DIN 7343 INOX A2 D 5x10	PIN
BS7	BS000700	NR	Rivetto alluminio Ø3x12	Aluminum rivet Ø3x12
BV1	BV000100	NR	Vite TE Parziale Filetto PG DIN 931 CI 8.8 M 8 x 80 Z.Bianca	Screw Partial Thread DIN 931 PG CI 8.8 M 8 x 80 Z. white
BV2	BV000200	NR	Vite TE Tutto Filetto PG DIN 933 CI 8.8 M 8 x 60 Z.Bianca	Screw All Thread DIN 933 PG CI 8.8 M 8 x 60 Z. white
BV3	BV000300	NR	Vite TCEI PG DIN 912 CI 8.8 M 8 x 60 Z.Bianca	Screw DIN 912 PG CI 8.8 M8 x 60 Z. white
BV4	BV000400	NR	Vite TE Parziale Filetto PG DIN 931 CI 8.8 M 8 x 50 Z.Bianca	Screw Partial Thread DIN 931 PG CI 8.8 M 8 x 50 Z. white
BV5	BV000500	NR	Vite TCEI PG DIN 912 CI 8.8 M 8 x 45 Z.Bianca	Screw DIN 912 PG CI 8.8 M8 x 45 Z. white
BV6	BV000600	NR	Vite TCEI PG DIN 912 CI 8.8 M 8 x 40 Z.Bianca	Screw DIN 912 PG CI 8.8 M8 x 40 Z.Bianca
BV7	BV000700	NR	Vite TE Tutto Filetto PG DIN 933 CI 8.8 M 8 x 35 Z.Bianca	Screw All Thread DIN 933 PG CI 8.8 M 8 x 35 Z. white
BV8	BV000800	NR	Vite TE Tutto Filetto PG DIN 933 CI 8.8 M 8 x 30 Z.Bianca	Screw All Thread DIN 933 PG CI 8.8 M 8 x 30 Z. white
BV9	BV000900	NR	Vite TE Tutto Filetto PG DIN 933 CI 8.8 M 8 x 25 Z.Bianca	Screw All Thread DIN 933 PG CI 8.8 M 8 x 25 Z. white
BV10	BV001000	NR	Vite TCEI PG DIN 912 CI 8.8 M 8 x 25 Z.Bianca	Screw DIN 912 PG CI 8.8 M8 x 25 Z. white
BV11	BV001100	NR	Vite TE Tutto Filetto PG DIN 933 CI 8.8 M 8 x 20 Z.Bianca	Screw All Thread DIN 933 PG CI 8.8 M 8 x 20 Z. white



POS	Codice	U.M.	 Descrizione	 Description
BV12	BV001200	NR	Vite TE Tutto Filetto PG DIN 933 CI 8.8 M 8 x 16 Z.Bianca	Screw All Thread DIN 933 PG CI 8.8 M 8 x 16 Z. white
BV13	BV001300	NR	Vite TCEI PG DIN 912 CI 8.8 M 8 x 16 Z.Bianca	Screw DIN 912 PG CI 8.8 M8 x 16 Z. white
BV14	BV001400	NR	Vite TE Tutto Filetto PG DIN 933 CI 8.8 M 8 x 14 Z.Bianca	Screw All Thread DIN 933 PG CI 8.8 M 8 x 14 Z. white
BV15	BV001500	NR	Vite TCEI PG DIN 912 CI 8.8 M 6 x 45 Z.Bianca	Screw DIN 912 M6 x 45 CI 8.8 Z. white
BV16	BV001600	NR	Vite TCEI PG DIN 912 CI 8.8 M 6 x 30 Z.Bianca	Screw DIN 912 M6 x 30 CI 8.8 Z. white
BV17	BV001700	NR	Vite TSPEI PG DIN 7991 CI 10.9 M 6 x 30 Z.Bianca	screw DIN 7991 CI 10.9 M 6 x 30 Z. white
BV18	BV001800	NR	Vite TE Tutto Filetto PG DIN 933 CI 8.8 M 6 x 30 Z.Bianca	Screw All Thread DIN 933 PG CI 8.8 M 6 x 30 Z. white
BV19	BV001900	NR	Vite TBEI PG ISO 7380 CI 10.9 M 6 x 30 Z.Bianca	screw ISO 7380 CI 10.9 M 6 x 30 Z. white
BV20	BV002000	NR	Vite TE Tutto Filetto PG DIN 933 CI 8.8 M 6 x 12 Z.Bianca	Screw All Thread DIN 933 PG CI 8.8 M 6 x 12 Z. white
BV21	BV002100	NR	Vite TCEI PG DIN 912 CI 8.8 M 6 x 12 Z.Bianca	Screw DIN 912 PG CI 8.8 M 6 x 12 Z. white
BV22	BV002200	NR	Vite TCEI PG DIN 912 CI 8.8 M 5 x 45 Z.Bianca	Screw DIN 912 PG CI 8.8 M 5 x 45 Z. white
BV23	BV002300	NR	Vite TE UNF ANSI B18.2.1 GR.5 5/16 x 1" Z.Bianca	Screw UNF ANSI B18.2.1 GR.5 5/16 x 1 "Z. White
BV24	BV002400	NR	Vite TC Croce PG DIN 7985 CI 4.8 M 4 x 8 Z.Bianca	Cross head screw DIN 7985 PG CI 4.8 M 4 x 8 Z. white
BV25	BV002500	NR	Vite TCEI PG DIN 912 CI 8.8 M 4 x 16 Z.Bianca	Screw DIN 912 PG CI 8.8 M 4 x 16 Z. white
BV26	BV002600	NR	Vite TCEI PG DIN 912 CI 8.8 M 6 x 50 Z.Bianca	Screw DIN 912 PG CI 8.8 M 6 x 50 Z. white
BV27	BV002700	NR	Vite TSPEI PG DIN 7991 CI 10.9 M 6 x 40 Z.Bianca	screw DIN 7991 CI 10.9 M 6 x 40 Z. white
BV28	BV002800	NR	Vite TSPEI PG DIN 7991 CI 10.9 M 6 x 25 Z.Bianca	screw DIN 7991 CI 10.9 M 6 x 25 Z. white
BV29	BV002900	NR	Vite TE Tutto Filetto PG DIN 933 CI 8.8 M 6 x 25 Z.Bianca	Screw All Thread DIN 933 PG CI 8.8 M 6 x 25 Z. white

POS	Codice	U.M.	 Descrizione	 Description
BV30	BV003000	NR	Vite TE Tutto Filetto PG DIN 933 CI 8.8 M 6 x 22 Z.Bianca	Screw All Thread DIN 933 PG CI 8.8 M 6 x 22 Z. white
BV31	BV003100	NR	Vite TSPEI PG DIN 7991 CI 10.9 M 6 x 20 Z.Bianca	screw DIN 7991 CI 10.9 M 6 x 20 Z. white
BV32	BV003200	NR	Vite TE Tutto Filetto PG DIN 933 CI 8.8 M 6 x 20 Z.Bianca	Screw All Thread DIN 933 PG CI 8.8 M 6 x 20 Z. white
BV33	BV003300	NR	Vite TCEI PG DIN 912 CI 8.8 M 6 x 20 Z.Bianca	Screw DIN 912 PG CI 8.8 M 6 x 20 Z. white
BV34	BV003400	NR	Vite TE Tutto Filetto PG DIN 933 CI 8.8 M 6 x 16 Z.Bianca	Screw All Thread DIN 933 PG CI 8.8 M 6 x 16 Z. white
BV35	BV003500	NR	Vite TBEI PG ISO 7380 CI 10.9 M 6 x 16 Z.Bianca	screw ISO 7380 CI 10.9 M 6 x 16 Z. white
BV36	BV003600	NR	Vite TCEI PG DIN 912 CI 8.8 M 5 x 8 Z.Bianca	Screw DIN 912 PG CI 8.8 M 5 x 8 Z. white
BV37	BV003700	NR	Vite TSPEI PG DIN 7991 CI 10.9 M 5 x 60 Z.Bianca	screw DIN 7991 CI 10.9 M 5 x 60 Z. white
BV38	BV003800	NR	Vite TE Parziale Filetto PG DIN 931 CI 8.8 M 5 x 60 Z.Bianca	Screw Partial Thread DIN 931 PG CI 8.8 M 5 x 60 Z. white
BV39	BV003900	NR	Vite TCEI PG DIN 912 CI 8.8 M 5 x 60 Z.Bianca	Screw DIN 912 PG CI 8.8 M 5 x 60 Z. white
BV40	BV004000	NR	Vite TE Parziale Filetto PG DIN 931 CI 8.8 M 5 x 55 Z.Bianca	Screw Partial Thread DIN 931 PG CI 8.8 M 5 x 55 Z. white
BV41	BV004100	NR	Vite TE Tutto Filetto PG DIN 933 CI 8.8 M 5 x 16 Z.Bianca	Screw All Thread DIN 933 PG CI 8.8 M 5 x 16 Z. white
BV42	BV004200	NR	Vite TC Croce PG DIN 7985 CI 4.8 M 5 x 16 Z.Bianca	Cross head screw DIN 7985 PG CI 4.8 M 5 x 16 Z. white
BV43	BV004300	NR	Vite TE Tutto Filetto PG DIN 933 CI 8.8 M 5 x 12 Z.Bianca	Screw All Thread DIN 933 PG CI 8.8 M 5 x 12 Z. white
BV44	BV004400	NR	Vite TE UNF ANSI B18.2.1 GR.5 5/16 x 1"1/4 Z.Bianca	Screw UNF ANSI B18.2.1 GR.5 5/16 x 1 "1/4 Z. White
BV45	BV004500	NR	Vite TE UNF ANSI B18.2.1 GR.5 5/16 x 1"1/4 Z.Bianca	Screw UNF ANSI B18.2.1 GR.5 5/16 x 1 "1/4 Z. White
BV46	BV004600	NR	Vite TCEI PG DIN 912 CI 8.8 M 4 x 40 Z.Bianca	Screw DIN 912 PG CI 8.8 M 4 x 40 Z. white
BV47	BV004700	NR	Vite Trilob. Autoform. TC Croce PG DIN 7500-C C15 M 4 x 40 Z.Bianca	Trilob Screw. Autoform. TC Cross PH DIN 7500-C C 15 M 4 x 40 Z. white

POS	Codice	U.M.	 Descrizione	 Description
BV48	BV004800	NR	Vite Trilob. Autoform. TC Croce PG DIN 7500-C C15 M 4 x 20 Z.Bianca	Trilob Screw. Autoform. TC Cross PG DIN 7500-C C15 M 4 x 20 Z. white
BV49	BV004900	NR	Vite TC Croce PG DIN 7985 CI 4.8 M 4 x 16 Z.Bianca	Cross head screw DIN 7985 PG CI 4.8 M 4 x 16 Z. white
BV50	BV005000	NR	VITE AUTOFIETTANTE TE C/BORDINO DIN 6928 C15 4,8X50 Z.Bianca	TAPPING SCREW TE C / BORDINO DIN 6928 C15 4.8 X50 Z. white
BV51	BV005100	NR	VITE AUTOFIETTANTE TE C/BORDINO DIN 6928 C15 4,8X25 Z.Bianca	TAPPING SCREW TE C / BORDINO DIN 6928 C15 4.8 X25 Z. white
BV52	BV005200	NR	Vite TCEI PG DIN 912 CI 12.9 M 3 x 25 Z.D.Bianca	Screw DIN 912 M 3 CI 12.9 x 25 Z.D. white
BV53	BV005300	NR	Vite TSPEI PG DIN 7991 CI 10.9 M 3 x 14 Z.Bianca	Screw DIN 7991 CI 10.9 M 3 x 14 Z. white
BV54	BV005400	NR	Vite Autofil.TC Croce DIN 7981 C15 3,5 x 6,5 Z.Bianca	Autofil.TC Cross Screw DIN 7981 C15 3.5 x 6.5 Z. white
BV55	BV005500	NR	Vite TE Parziale Filetto PG DIN 931 CI 10.9 M 16 x 55	Screw Partial Thread DIN 931 PG CI 10.9 M 16 x 55
BV56	BV005600	NR	Vite TE Tutto Filetto PG DIN 933 CI 8.8 M 16 x 40 Z.Bianca	Screw All Thread DIN 933 PG CI 8.8 M 16 x 40 Z. white
BV57	BV005700	NR	Vite TE Parziale Filetto PG DIN 931 CI 10.9 M 16 x 220	Screw Partial Thread DIN 931 PG CI 10.9 M 16 x 220
BV58	BV005800	NR	Vite TE 8.8 DIN933 M16x20 Testa Alta 8 Zn Bianca	Screw M16x20 DIN933 8.8 Head High 8 Zn White
BV59	BV005900	NR	Vite TE Tutto Filetto PG DIN 933 CI 8.8 M 12 x 16 Z.Bianca	Screw All Thread DIN 933 PG CI 8.8 M 12 x 16 Z. white
BV60	BV006000	NR	Vite TE Parziale Filetto PG DIN 931 CI 8.8 M 12 x 120 Z.Bianca	Screw Partial Thread DIN 931 PG CI 8.8 M 12 x 120 Z. white
BV61	BV006100	NR	Vite TE Parziale Filetto PG DIN 931 CI 8.8 M 10 x 50 Z.Bianca	Screw Partial Thread DIN 931 PG CI 8.8 M 10 x 50 Z. white
BV62	BV006200	NR	Vite TE Tutto Filetto PG DIN 933 CI 8.8 M 10 x 35 Z.Bianca	Screw All Thread DIN 933 PG CI 8.8 M 10 x 35 Z. white
BV63	BV006300	NR	Vite TSPEI PG DIN 7991 CI 10.9 M 10 x 30 Z.Bianca	Screw DIN 7991 CI 10.9 M 10 x 30 Z. white
BV64	BV006400	NR	Vite TE Tutto Filetto PG DIN 933 CI 8.8 M 10 x 30 Z.Bianca	Screw All Thread DIN 933 PG CI 8.8 M 10 x 30 Z. white

POS	Codice	U.M.	 Descrizione	 Description
BV65	BV006500	NR	Vite TCEI PG DIN 912 CI 12.9 M 10 x 25 Geo 321 A	Screw DIN 912 PG CI 12.9 M 10 x 25 Geo 321 A
BV66	BV006600	NR	Vite TCEI PG DIN 912 CI 8.8 M 10 x 25 Z.Bianca	Screw DIN 912 PG CI 8.8 M 10 x 25 Z. white
BV67	BV006700	NR	Vite TE Tutto Filetto PG DIN 933 CI 8.8 M 10 x 20 Z.Bianca	Screw All Thread DIN 933 PG CI 8.8 M 10 x 20 Z. white
BV68	BV006800	NR	Vite TE Tutto Filetto PG DIN 933 CI 8.8 M 10 x 18 Z.Bianca	Screw All Thread DIN 933 PG CI 8.8 M 10 x 18 Z. white
BV69	BV006900	NR	Vite Trilob. Autoform. TSP Croce PG DIN 7500-M C15 M 5 x 16 Z.Bianca	Trilob Screw. Autoform. TSP Cross PG DIN 7500-M C15 M 5 x 16 Z. white
BV70	BV007000	NR	Vite TE Parziale Filetto PG DIN 931 CI 8.8 M 8 x 70 Z.Bianca	Screw Partial Thread DIN 931 PG CI 8.8 M 8 x 70 Z. white
BV71	BV007100	NR	Vite TE Parziale Filetto PG DIN 931 CI 8.8 M 8 x 65 Z.Bianca	Screw Partial Thread DIN 931 PG CI 8.8 M 8 x 65 Z. white
BV72	BV007200	NR	Vite TE Parziale Filetto PG DIN 931 CI 8.8 M 6 x 55 Z.Bianca	Screw Partial Thread DIN 931 PG CI 8.8 M 6 x 55 Z. white
BV73	BV007300	NR	Vite TCEI PG DIN 912 CI 8.8 M 6 x 55 Z.Bianca	Screw DIN 912 PG CI 8.8 M 6 x 55 Z. white
BV74	BV007400	NR	Vite TCEI PG DIN 912 CI 8.8 M 6 x 16 Z.Bianca	Screw DIN 912 PG CI 8.8 M 6 x 16 Z. white
BV75	BV007500	NR	Vite TSPEI PG DIN 7991 CI 10.9 M 6 x 10 Z.Bianca	Screw DIN 7991 CI 10.9 M 6 x 10 Z. white
BV76	BV007600	NR	Vite TCEI PG DIN 912 CI 8.8 M 5 x 55 Z.Bianca	Screw DIN 912 PG CI 8.8 M 5 x 55 Z. white
BV77	BV007700	NR	Vite TC Croce PG DIN 7985 CI 4.8 M 6 x 16 Z.Bianca	Cross head screw DIN 7985 PG CI 4.8 M 6 x 16 Z. white
BV78	BV007800	NR	Vite Trilob. Autoform. TC Croce PG DIN 7500-C C15 M 5 x 12 Z.Bianca	Trilob Screw. Autoform. TC Cross PG DIN 7500-C C15 M 5 x 12 Z. white
BV79	BV007900	NR	Vite TE Tutto Filetto PG DIN 933 CI 8.8 M 4 x 35 Z.Bianca	Screw All Thread DIN 933 PG CI 8.8 M 4 x 35 Z. white
BV80	BV008000	NR	VITE AUTOFIETTANTE TE C/BORDINO DIN 6928 C15 4,8X35 Z.Bianca	TAPPING SCREW TE C / BORDINO DIN 6928 C15 4.8 X35 Z. white
BV81	BV008100	NR	Vite TCEI PG DIN 912 CI 12.9 M 3 x 14 Z.D.Bianca	Screw DIN 912 M 3 CI 12.9 x 14 Z.D. white

POS	Codice	U.M.	 Descrizione	 Description
BV82	BV008200	NR	Vite TE Parziale Filetto PG DIN 931 CI 8.8 M 16 x 70 Z.Bianca	Screw Partial Thread DIN 931 PG CI 8.8 M 16 x 70 Z. white
BV83	BV008300	NR	Vite TE Parziale Filetto PG DIN 931 CI 8.8 M 16 x 260 Z.Bianca	Screw Partial Thread DIN 931 PG CI 8.8 M 16 x 260 Z. white
BV84	BV008400	NR	Vite TE Parziale Filetto PG DIN 931 CI 8.8 M 12 x 110 Z.Bianca	Screw Partial Thread DIN 931 PG CI 8.8 M 12 x 110 Z. white
BV85	BV008500	NR	Vite TE Tutto Filetto PG DIN 933 CI 8.8 M 10 x 40 Z.Bianca	Screw Thread DIN 933 PG CI 8.8 M 10 x 40 Z. white
BV86	BV008600	NR	Vite TCEI PG DIN 912 CI 8.8 M 8 x 65 Z.Bianca	Screw DIN 912 PG CI 8.8 M 8 x 65 Z. white
BV87	BV008700	NR	Vite TCEI PG DIN 912 CI 8.8 M 8 x 20 Z.Bianca	Screw DIN 931 PG CI 8.8 M 10 x 40 Z. white
BV88	BV008800	NR	Vite TCEI PG DIN 912 CI 10.9 M 10 x 18 Z.Bianca	Screw DIN 912 PG CI 10.9 M 10 x 18 Z. white
BV89	BV008900	NR	Vite TCEI PG DIN 912 CI 8.8 M 8 x 70 Z.Bianca	Screw DIN 912 PG CI 8.8 M 8 x 70 Z. white
BV91	BV009100	NR	Vite TE Parziale Filetto PG DIN 931 CI 8.8 M 6 x 40 Z.Bianca	Screw Partial Thread DIN 931 PG CI 8.8 M 6 x 40 Z. white
BV92	BV009200	NR	Vite TE Tutto Filetto PG DIN 933 CI 8.8 M 10 x 60 Z.Bianca	Screw All Thread DIN 933 PG CI 8.8 M 10 x 60 Z. white
BV93	BV009300	NR	Vite TSPEI PG DIN 7991 CI 10.9 M 5 x 20 Z.Bianca	screw DIN 7991 CI 10.9 M 5 x 20 Z. white
BV94	BV009400	NR	Vite TC Croce PG DIN 7985 CI 4.8 M 4 x 12 Z.Bianca	Cross head screw DIN 7985 PG CI 4.8 M 4 x 12 Z. white
BV95	BV009500	NR	Vite TE Tutto Filetto PG DIN 933 CI 8.8 M 4 x 12 Z.Bianca	Screw All Thread DIN 933 PG CI 8.8 M 4 x 12 Z. white
BV96	BV009600	NR	Vite TCEI PG DIN 912 CI 12.9 M 12 x 30 Dac 320A	Screw DIN 912 CI 12.9 M 12 x 30 Dac 320A
BV97	BV009700	NR	Vite Autofil.Testa Mezza Tonda C15 4,8 x 13 Z.Bianca	Half Round Head Self Tapping Screw C15 4,8 x 13
BV98	BV009800	NR	Vite TC Croce PG DIN 7985 CI 4.8 M 4 x 14 Z.Bianca	Screw DIN 7985 CI 4.8 M 4 x 14
BV99	BV009900	NR	Vite TE Parziale Filetto PG DIN 931 CI 8.8 M 5 x 65 Z.Bianca	Screw Partial Thread DIN 931 PG CI 8.8 M 5 x 65 Z. white



POS	Codice	U.M.	 Descrizione	 Description
BV100	BV010000	NR	Vite Autofil. Testa Mezza Tonda C15 4,8 x 16 Z.Bianca	Half Round Head Self Tapping Screw C15 4,8 x 16
BV101	BV010100	NR	Vite TSPEI PG DIN 7991 CI 10.9 M 8 x 25 Z.Bianca	screw DIN 7991 CI 10.9 M 8 x 25 Z. white
BV102	BV010200	NR	Vite TCEI PG DIN 912 CI 8.8 M 4 x 30 Z.Bianca	Screw DIN 912 PG CI 8.8 M 4 x 30 White Z
BV103	BV010300	NR	Vite TSPEI PG DIN 7991 CI 10.9 M 5 x 16 Z.Bianca	Screw DIN 7991 CI 10.9 M 5 x 16 Z. white
BV104	BV010400	NR	Vite TCEI bassa PG DIN 7984 CI 10.9 M 12 x 18 Z.D.Bianca	Screw DIN 7984 low PG CI 10.9 M 12 x 18 Z. D. white
BV105	BV010500	NR	Vite TE Parziale Filetto PG DIN 931 CI 8.8 M 12 x 75 Z.Bianca	Screw Partial Thread DIN 931 PG CI 8.8 M 12 x 75 Z. white
BV106	BV010600	NR	Vite TE Tutto Filetto PG DIN 933 CI 8.8 M 8 x 22 Z.Bianca	Screw All Thread DIN 933 PG CI 8.8 M 8 x 22 Z. white
BV107	BV010700	NR	Vite TE Tutto Filetto PG DIN 933 CI 8.8 M 6 x 35 Z.Bianca	Screw All Thread DIN 933 PG CI 8.8 M 6 x 35 Z. white
BV108	BV010800	NR	Vite TE Parziale Filetto PG DIN 931 CI 8.8 M 4 x 45 Z.Bianca	Screw Partial Thread DIN 931 PG CI 8.8 M 4 x 45 Z. white
BV109	BV010900	NR	Vite TE Tutto Filetto PG DIN 933 CI 10.9 M 16 x 45 Z.D.Bianca	Screw All Thread DIN 933 PG CI 10.9 M 16 x 45 ZD white
BV110	BV011000	NR	Vite TE Parziale Filetto PG DIN 931 CI 10.9 M 16 x 100	Screw Partial Thread DIN 931 PG CI 10.9 M 16 x 100
BV111	BV011100	NR	Vite TE Parziale Filetto PG DIN 931 CI 10.9 M 16 x 105	Screw Partial Thread DIN 931 PG CI 10.9 M 16 x 105
BV112	BV011200	NR	Vite TE Tutto Filetto PG DIN 933 CI 8.8 M 10 x 25 Z.Bianca	Screw All Thread DIN 933 PG CI 8.8 M 10 x 25 Z. white
BV113	BV011300	NR	Vite TSPEI PG DIN 7991 CI 10.9 M 6 x 50 Z.Bianca	TSPEI PG screw DIN 7991 CI 10.9 M 6 x 50 Z. white
BV114	BV011400	NR	Vite TSPEI PG DIN 7991 CI 10.9 M 8 x 25 Z.Bianca	TSPEI PG screw DIN 7991 CI 10.9 M 8 x 25 Z. white
BV115	BV011500	NR	Vite TE Tutto Filetto PG DIN 933 CI 8.8 M 10 x 45 Z.Bianca	Screw All Thread DIN 933 PG CI 8.8 M 10 x 45 Z. white
BV116	BV011600	NR	Vite TE Tutto Filetto PG DIN 933 CI 8.8 M 5 x 8 Z.Bianca	Screw All Thread DIN 933 PG CI 8.8 M 5 x 8 Z. white

POS	Codice	U.M.	 Descrizione	 Description
BV117	BV011700	NR	Vite TE Tutto Filetto PG DIN 933 CI 8.8 M 8 x 18 Z.Bianca	Screw All Thread DIN 933 PG CI 8.8 M 8 x 18 Z. white
BV118	BV011800	NR	Vite TE Tutto Filetto PG DIN 933 CI 8.8 M 8 x 40 Z.Bianca	Screw All Thread DIN 933 PG CI 8.8 M 8 x 40 Z. white
BV119	BV011900	NR	Vite TCEI PG DIN 912 CI 8.8 M 8 x 100 Z.Bianca	Screw DIN 912 PG CI 8.8 M 8 x 100 Z. white
BV120	BV012000	NR	Vite TCEI PG DIN 912 CI 8.8 M 8 x 110 Z.Bianca	Screw DIN 912 PG CI 8.8 M 8 x 110 Z. white
BV121	BV012100	NR	Vite TE Parziale Filetto PG DIN 931 CI 8.8 M 5 x 75 Z.Bianca	Screw Partial Thread DIN 931 PG CI 8.8 M 5 x 75 Z. white
BV122	BV012200	NR	Vite TE Parziale Filetto PG DIN 931 CI 8.8 M 12 x 130 Z.Bianca	Screw Partial Thread DIN 931 PG CI 8.8 M 12 x 130 Z. white
BV123	BV012300	NR	Vite TC Croce PG DIN 7985 CI 4.8 M 4 x 8 Z.Bianca	Cross head screw DIN 7985 PG CI 4.8 M 4 x 8 Z. white
BV124	BV012400	NR	Vite TCEI PG DIN 912 CI 8.8 M 6 x 40 Z.Bianca	Screw DIN 912 PG CI 8.8 M 6 x 40 Z. white
BV125	BV012500	NR	Vite TE Tutto Filetto PG DIN 933 CI 8.8 M 4 x 20 Z.Bianca	Screw All Thread DIN 933 PG CI 8.8 M 4 x 20 Z. white
BV126	BV012600	NR	Vite TE UNC ANSI B18.2.1 GR.5 3/8 x 1" Z.Bianca	Screw UNC ANSI B18.2.1 GR.5 3/8 x 1 "Z. White
BV127	BV012700	NR	Vite TE UNC ANSI B18.2.1 GR.5 3/8 x 1" 1/4Z.Bianca	Screw UNC ANSI B18.2.1 GR.5 3/8 x 1 "1/4 Z. White
BV128	BV012800	NR	Vite TE Tutto Filetto PG DIN 933 CI 8.8 M 4 x 16 Z.Bianca	Screw All Thread DIN 933 PG CI 8.8 M 4 x 16 Z. white
BV129	BV012900	NR	Vite TCEI PG DIN 912 CI 8.8 M 5 x 16 Z.Bianca	Screw DIN 912 PG CI 8.8 M 5 x 16 Z. white
BV130	BV013000	NR	Vite TCEI PG DIN 912 CI 8.8 M 3 x 12 Z.Bianca	Screw DIN 912 PG CI 8.8 M 3 x 12 Z. white
BV131	BV013100	NR	Vite TSPEI PG DIN 7991 CI 10.9 M 5 x 30 Z.Bianca	TSPEI PG screw DIN 7991 CI 10.9 M 5 x 30 Z. white
BV132	BV013200	NR	Vite TSPEI PG DIN 7991 CI 10.9 M 5 x 55 Z.Bianca	TSPEI PG screw DIN 7991 CI 10.9 M 5 x 55 Z. white
BV133	BV013300	NR	Vite TE Tutto Filetto PG DIN 933 CI 8.8 M 3 x 25 Z.Bianca	Screw All Thread DIN 933 PG CI 8.8 M 3 x 25 Z. white

POS	Codice	U.M.	 Descrizione	 Description
BV134	BV013400	NR	Vite TE Parziale Filetto PG DIN 931 CI 8.8 M 10 x 65 Z.Bianca	Screw Partial Thread DIN 931 PG CI 8.8 M 10 x 65 Z. white
BV135	BV013500	NR	Vite TCEI PG DIN 912 CI 8.8 M 12 x 50	Screw DIN 912 CI 9.8 M 12 x 50
BV136	BV013600	NR	Vite TSPEI PG DIN 7991 CI 10.9 M 5 x 25 Z.Bianca	TSPEI PG screw DIN 7991 CI 10.9 M 5 x 25 Z. white
BV137	BV013700	NR	Vite TCEI PG DIN 912 CI 8.8 M 8 x 30	Screw DIN 912 CI 8.8 M 8 x 30
BV138	BV013800	NR	Vite TC Croce PG DIN 7985 CI 4.8 M 5 x 10 Z.Bianca	Screw DIN 7985 CI 4.8 M 5 x 10
BV139	BV013900	NR	Vite TCEI PG DIN 912 CI 8.8 M 4 x 25 Z. Bianca	Screw DIN 912 CI 8.8 M 4 x 25 Z. Withe
BV140	BV014000	NR	Vite TE Parziale Filetto PG DIN 931 CI 8.8 M 5 x 70 Z.Bianca	Screw Partial Thread DIN 931 PG CI 8.8 M 5 x 70 Z. white
BV141	BV014100	NR	Vite TE Parziale Filetto PG DIN 931 CI 8.8 M 12 x 90 Z.Bianca	Screw Partial Thread DIN 931 PG CI 8.8 M 12 x 90 Z. white
BV142	BV014200	NR	Vite TE Parziale Filetto PG DIN 931 CI 8.8 M 8 x 55 Z.Bianca	Screw Partial Thread DIN 931 PG CI 8.8 M 8 x 55 Z. white
BV143	BV014300	NR	Vite TSPEI PG DIN 7991 CI 10.9 M 10 x 20 Z.Bianca	TSPEI PG screw DIN 7991 CI 10.9 M 10 x 20 Z. white
BV144	BV014400	NR	Vite TE Tutto Filetto PG DIN 933 CI 8.8 M 12 x 20 Z.Bianca	Screw All Thread DIN 933 PG CI 8.8 M 12 x 20 Z. white
BV145	BV014500	NR	Vite TE Tutto Filetto PG DIN 933 CI 8.8 M 12 x 35 Z.Bianca	Screw All Thread DIN 933 PG CI 8.8 M 12 x 35 Z. white
BV146	BV014600	NR	Vite TE Tutto Filetto PF DIN 961 CI 10.9 M 10 x 1,25 x 25 Z.D.Bianco	All PF thread hex head screw DIN 961 CI 10.9 M 10 x 1,25 x 25 Z.Bianca
BV147	BV014700	NR	Vite TSPEI PARZIALE FILETTO PG DIN 7991 CI 10.9 M 12 x 90 Z.Bianca	TSPEI partial THREAD PG screw DIN 7991 CI 10.9 M12 x 90 Z. white
BV148	BV014800	NR	Vite TSPEI PG DIN 7991 CI 10.9 M 6 x 16 Z.Bianca	TSPEI PG screw DIN 7991 CI 10.9 M6 x 16 Z. white
BV149	BV014900	NR	Vite TBEI PG ISO 7380 CI 10.9 M 6 x 20 Z.Bianca	Hex socket screw ISO 7380 PG CI 10.9 M 6 x 20 Z. white
BV150	BV015000	NR	Vite TE Tutto Filetto PG DIN 933 CI 10.9 M 14 x 40 Z.Bianca	Screw All Thread DIN 933 PG CI 10.9 M 14 x 40 Z. white

POS	Codice	U.M.	 Descrizione	 Description
BV151	BV015100	NR	Vite TE Parziale Filetto PG DIN 931 CI 8.8 M 10 x 85 Z.Bianca	Screw Partial Thread DIN 931 PG CI 8.8 M 10 x 85 Z. white
BV152	BV015200	NR	Vite TE Parziale Filetto PG DIN 931 CI 8.8 M 10 x 75 Z.Bianca	Screw Partial Thread DIN 931 PG CI 8.8 M 10 x 75 Z. white
BV154	BV015400	NR	Vite TCEI PG DIN 912 CI 8.8 M 8 x 35	Screw DIN 912 CI 8.8 M 8 x 35
BV155	BV015500	NR	Vite TCEI PG DIN 912 CI 8.8 M 5 x 20 GEOMET 321A	Screw DIN 912 CI 8.8 M 5 x 20 GEOMET 321A
BV156	BV015600	NR	Vite TBEI PG ISO 7380 CI 10.9 M 6 x 25 Z.Bianca	Hex socket screw ISO 7380 PG CI 10.9 M 6 x 25 Z. white
BV157	BV015700	NR	Vite TBEI PG ISO 7380 CI 10.9 M 8 x 20 Z.Bianca	Hex socket screw ISO 7380 PG CI 10.9 M 8 x 20 Z. white
BV158	BV015800	NR	Vite TBEI PG ISO 7380 CI 10.9 M 6 x 70 Z.Bianca	Hex socket screw ISO 7380 PG CI 10.9 M 6 x 70 Z. white
BV159	BV015900	NR	Vite TBEI PG ISO 7380 CI 10.9 M 10 x 20 Z.Bianca	Hex socket screw ISO 7380 PG CI 10.9 M 10 x 20 Z. white
BV160	BV016000	NR	Vite TSPEI PG DIN 7991 CI 10.9 M 4 x 16 Z.Bianca	TSPEI PG screw DIN 7991 CI 10.9 M4 x 16 Z. white
BV162	BV016200	NR	Vite TCEI PG DIN 912 CI 12.9 M14 x 45 GEOMET 321A	Screw DIN 912 CI 12.9 M14 x 45 GEOMET 321A
BV163	BV016300	NR	Vite TCEI PG DIN 912 CI 8.8 M6 x 35	Screw DIN 912 CI 8.8 M6 x 35
BV164	BV016400	NR	Vite TCEI PG DIN 912 CI 8.8 M10 x 35	Screw DIN 912 CI 8.8 M10 x 35
BV165	BV016500	NR	Vite TE Tutto Filetto PG DIN 933 CI 8.8 M8 x 12 Z.Bianca	Screw All Thread DIN 933 PG CI 8.8 M8 x 12 Z. white
BV166	BV016600	NR	Vite TCEI PG DIN 912 CI 8.8 M4 x 20 Z. BIANCA	Screw DIN 912 CI 8.8 M4 x 20 Z. WITHE
BV167	BV016700	NR	Vite TCEI PG DIN 912 CI 8.8 M4 x 20 GEOMET 321A	All PF thread hex head screw DIN 961 CI 8.8 M 12 x 1,25 x 30 Z.Bianca
BV168	BV016800	NR	Vite TE Tutto Filetto PF DIN 961 CI 8.8 M 10 x 1,25 x 30 Z.Bianca	All PF thread hex head screw DIN 961 CI 8.8 M 10 x 1,25 x 30 Z.Bianca
BV169	BV016900	NR	Vite TCEI PG DIN 912 CI 8.8 M 10 x 1,25 x 30 ZINCATA BIANCA	Screw DIN 912 CI 8.8 M10 x 1,25 x 30

POS	Codice	U.M.	 Descrizione	 Description
BV170	BV017000	NR	Vite TE Parziale Filetto PF DIN 960 CI 8.8 M 10 x 1,25 x 60 Z.Bianca	Partial PF thread hex head screw DIN 960 CI 8.8 M 10 x 1,25 x 60 Z.Bianca
BV171	BV017100	NR	Vite TE Tutto Filetto PF DIN 961 CI 10.9 M 12 x 1,25 x 25 Z.Bianca	All PF thread hex head screw DIN 961 CI 10.9 M 12 x 1,25 x 25 Z.Bianca
BV172	BV017200	NR	Vite TE UNC ANSI B18.2.1 GR.5 5/8 passo 11 L= 1" 1/2 GEOMET 500	UNC hex head screw ANSI B18.2.1 GR.5 5/8 11 L = 1 "1/2 GEOMET 500
BV173	BV017300	NR	Vite TE Tutto Filetto PG DIN 933 CI 8.8 M12 x 30 Z.Bianca	Screw All Thread DIN 933 PG CI 8.8 M12 x 30 Z. white
BV174	BV017400	NR	Vite TE Tutto Filetto PG DIN 933 CI 8.8 M5 x 45 Z.Bianca	Screw All Thread DIN 933 PG CI 8.8 M5 x 45 Z. white
BV175	BV017500	NR	Vite TE Parziale Filetto PG DIN 931 CI 8.8 M 12 x 80 Z.Bianca	Screw Partial Thread DIN 931 PG CI 8.8 M12 x 80 Z. white
BV176	BV017600	NR	Vite TCEI PG DIN 912 CI 8.8 M 6 x 25 Z.Bianca	Screw DIN 912 CI 8.8 M6 x 25
BV177	BV017700	NR	Vite TE Parziale Filetto PG DIN 931 CI 8.8 M 12 x 85 Z.Bianca	Screw Partial Thread DIN 931 PG CI 8.8 M12 x 85 Z. white
BV178	BV017800	NR	Vite TE Tutto Filetto PG DIN 933 CI 8.8 M8 x 90 Z.Bianca	Screw All Thread DIN 933 PG CI 8.8 M8 x 90 Z. white
BV179	BV017900	NR	Vite TE Tutto Filetto PG DIN 933 CI 8.8 M5 x 40 Z.Bianca	Screw All Thread DIN 933 PG CI 8.8 M5 x 40 Z. white
BV180	BV018000	NR	Vite TE Tutto Filetto PG DIN 933 CI 8.8 M6 x 75 Z.Bianca	Screw All Thread DIN 933 PG CI 8.8 M6 x 75 Z. white
BV182	BV018200	NR	Vite TE Tutto Filetto PG DIN 933 CI 10.9 M 16 x 70 Z.Bianca	Screw All Thread DIN 933 PG CI 10.9 M 16 x 70 Z. white
BV183	BV018300	NR	Vite TE Tutto Filetto PG DIN 933 CI 8.8 M5 x 10 Z.Bianca	Screw All Thread DIN 933 PG CI 8.8 M5 x 10 Z. white
BV184	BV018400	NR	Vite TE Tutto Filetto PG DIN 933 CI 8.8 M10 x 16 Z.Bianca	Screw All Thread DIN 933 PG CI 8.8 M10 x 16 Z. white
BV185	BV018500	NR	Vite TCEI PG DIN 912 CI 8.8 M 8 x 55 Z.Bianca	Screw DIN 912 CI 8.8 M8 x 55
BV186	BV018600	NR	Vite TCEI PG DIN 912 CI 12.9 M10 x 30 GEOMET 321A	Screw DIN 912 CI 12.9 M10 x 30 GEOMET 321A
BV187	BV018700	NR	Vite TCEI PG DIN 912 CI 12.9 M14 x 40 GEOMET 321A	Screw DIN 912 CI 12.9 M14 x 40 GEOMET 321A



POS	Codice	U.M.	 Descrizione	 Description
BV188	BV018800	NR	Vite TE Tutto Filetto PG DIN 933 CI 8.8 M 12 x 60 Z.Bianca	Screw All Thread DIN 933 PG CI 8.8 M12 x 60 Z. white
BV189	BV018900	NR	Vite TE Tutto Filetto PG DIN 933 CI 8.8 M 12 x 55 Z.Bianca	Screw All Thread DIN 933 PG CI 8.8 M12 x 55 Z. white
BV190	BV019000	NR	Vite TE Tutto Filetto PG DIN 933 CI 8.8 M 12 x 50 Z.Bianca	Screw All Thread DIN 933 PG CI 8.8 M12 x 50 Z. white
BV191	BV019100	NR	Vite TE Tutto Filetto PG DIN 933 CI 8.8 M 16 x 50 Z.Bianca	Screw All Thread DIN 933 PG CI 8.8 M16 x 50 Z. white
BV192	BV019200	NR	Vite TE Tutto Filetto PG DIN 933 CI 8.8 M 16 x 55 Z.Bianca	Screw All Thread DIN 933 PG CI 8.8 M16 x 55 Z. white
BV193	BV019300	NR	Vite TE Parziale Filetto PG DIN 931 CI 8.8 M 10 x 55 Z.Bianca	Screw Partial Thread DIN 931 PG CI 8.8 M 10 x 55 Z. white
BV194	BV019400	NR	Vite TE Parziale Filetto PG DIN 931 CI 8.8 M 16 x 230 Z.Bianca	Screw Partial Thread DIN 931 PG CI 8.8 M 16 x 230 Z. white
BV195	BV019500	NR	Vite TE Parziale Filetto PG DIN 931 CI 8.8 M 6 x 50 Z.Bianca	Screw Partial Thread DIN 931 PG CI 8.8 M 6 x 50 Z. white
BV196	BV019600	NR	Vite TE Parziale Filetto PG DIN 931 CI 8.8 M 6 x 65 Z.Bianca	Screw Partial Thread DIN 931 PG CI 8.8 M 6 x 65 Z. white
BV197	BV019700	NR	Vite TE Parziale Filetto PG DIN 931 CI 8.8 M 8 x 45 Z.Bianca	Screw Partial Thread DIN 931 PG CI 8.8 M 8 x 45 Z. white
BV198	BV019800	NR	Vite TE Parziale Filetto PG DIN 931 CI 8.8 M 8 x 55 Z.Bianca	Screw Partial Thread DIN 931 PG CI 8.8 M 8 x 55 Z. white
BV199	BV019900	NR	Vite TE Parziale Filetto PG DIN 931 CI 8.8 M 8 x 60 Z.Bianca	Screw Partial Thread DIN 931 PG CI 8.8 M 8 x 60 Z. white
BV200	BV020000	NR	Vite TE Tutto Filetto PG DIN 933 CI 10.9 M 16 x 40	Screw All Thread DIN 933 PG CI 10.9 M 16 x 40
BV201	BV020100	NR	Vite TSPEI PG DIN 7991 CI 10.9 M16 x 45 Z.Bianca	TSPEI PG screw DIN 7991 CI 10.9 M16 x 45 Z. white
BV202	BV020200	NR	Vite TCEI PG DIN 912 CI 12.9 M3 x 12 ZINC. iridescente Fe/Zn5IVs	Screw DIN 912 CI 12.9 M3 x 12 ZINC. iridescente Fe/Zn5IVs
BV203	BV020300	NR	Vite TC Croce PG DIN 7985 CI 4.8 M M 3 x 5 Z.Bianca	Screw DIN 7985 CI 4.8 M M 3 x 5
BV204	BV020400	NR	Vite TC Croce PG DIN 7985 CI 4.8 M M 3 x 8 Z.Bianca	Screw DIN 7985 CI 4.8 M M 3 x 8

POS	Codice	U.M.	 Descrizione	 Description
BV205	BV020500	NR	Vite TTQST DIN 603/555 CI 4.8 M 8 x 35 Z.Bianca	TTQST Screw DIN 603/555 CL 4.8 M 8 x 35 Z. White
BV206	BV020600	NR	Vite TC Croce PG DIN 7985 CI 4.8 M M 5 x 80 Z.Bianca	Screw DIN 7985 CI 4.8 M M 5 x 80
BV207	BV020700	NR	Vite TE Parziale Filetto PG DIN 931 CI 8.8 M 10 x 80 Z.Bianca	Screw Partial Thread DIN 931 PG CI 8.8 M 10 x 80 Z. white
BV208	BV020800	NR	Vite TE Tutto Filetto PG DIN 933 CI 8.8 M 16 x 35 Z.D.Bianca	Screw All Thread DIN 933 PG CI 8.8 M 16 x 35 ZD white
BV209	BV020900	NR	Vite TE Parziale Filetto PG DIN 931 CI 8.8 M 10 x 95 Z.Bianca	Screw Partial Thread DIN 931 PG CI 8.8 M 10 x 95 Z. white
BV210	BV021000	NR	Vite TE Tutto Filetto PG DIN 933 CI 8.8 M 6 x 14 Z.D.Bianca	Screw All Thread DIN 933 PG CI 8.8 M 6 x 14 ZD white
BV211	BV021100	NR	Vite TE Tutto Filetto PG DIN 933 CI 8.8 M 12 x 25 Z.D.Bianca	Screw All Thread DIN 933 PG CI 8.8 M 12 x 25 ZD white
BV212	BV021200	NR	Vite TE Tutto Filetto PG DIN 933 CI 8.8 M 4 x 14 Z.D.Bianca	Screw All Thread DIN 933 PG CI 8.8 M 4 x 14 ZD white
BV213	BV021300	NR	Vite TE Tutto Filetto PG DIN 933 CI 10.9 M 16 x 60	Screw All Thread DIN 933 PG CI 10.9 M 16 x 60
BV214	BV021400	NR	Vite TE Parziale Filetto PG DIN 931 CI 8.8 M 6 x 100 Z.Bianca	Screw Partial Thread DIN 931 PG CI 8.8 M 6 x 100 Z. white
BV215	BV021500	NR	Vite TE Parziale Filetto PG DIN 931 CI 10.9 M 16 x 110	Screw Partial Thread DIN 931 PG CI 10.9 M 16 x 110
BV216	BV021600	NR	Vite TE Parziale Filetto PG DIN 931 CI 10.9 M 16 x 240 Z.D.Bianca	Screw Partial Thread DIN 931 PG CI 10.9 M 16 x 240 ZD white
BV217	BV021700	NR	Vite TSPEI PG DIN 7991 CI 10.9 M 8 x 30 Z.Bianca	TSPEI PG screw DIN 7991 CI 10.9 M8 x 30 Z. white
BV218	BV021800	NR	Vite TSPEI PG DIN 7991 CI 10.9 M 5 x 6 Z.Bianca	TSPEI PG screw DIN 7991 CI 10.9 M5 x 6 Z. white
BV219	BV021900	NR	Vite TSPEI PG DIN 7991 CI 10.9 M 5 x 70 Z.Bianca	TSPEI PG screw DIN 7991 CI 10.9 M5 x 70 Z. white
BV220	BV022000	NR	Vite TSPEI PG DIN 7991 CI 10.9 M 12 x 35 Z.Bianca	TSPEI PG screw DIN 7991 CI 10.9 M12 x 35 Z. white
BV221	BV022100	NR	Vite TCEI PG DIN 912 CI 12.9 M10 x 20 GEOMET 321A	Screw DIN 912 CI 12.9 M10 x 20 GEOMET 321A



POS	Codice	U.M.	 Descrizione	 Description
BV222	BV022200	NR	Vite TCEI PG DIN 912 CI 12.9 M8 x 90 GEOMET 321A	Screw DIN 912 CI 12.9 M8 x 90 GEOMET 321A
BV223	BV022300	NR	Vite TCEI PG DIN 912 CI 12.9 M3 x 5 ZINC.	Screw DIN 912 CI 12.9 M3 x 5 ZINC.
BV224	BV022400	NR	Vite TBEI PG ISO 7380 CI 10.9 M 8 x 22 Z.Bianca	Hex socket screw ISO 7380 PG CI 10.9 M 8 x 22 Z. white
BV225	BV022500	NR	Vite TE Parziale Filetto PG DIN 931 CI 8.8 M 10 x 100 Z.Bianca	Screw Partial Thread DIN 931 PG CI 8.8 M 10 x 100 Z. white
BV226	BV022600	NR	Vite TE Parziale Filetto PG DIN 931 CI 8.8 M 10 x 110 Z.Bianca	Screw Partial Thread DIN 931 PG CI 8.8 M 10 x 110 Z. white
BV227	BV022700	NR	Vite TE parziale Filetto PG DIN 931 CI 10.9 M 12 x 45 Z.D.Bianca	Screw partial Thread DIN 931 PG CI 10.9 M 12 x 45 ZD white
BV228	BV022800	NR	Vite TE Tutto Filetto PG DIN 933 CI 10.9 M 14 x 35 Z.D.Bianca	Screw All Thread DIN 933 PG CI 10.9 M 14 x 35 ZD white
BV229	BV022900	NR	Vite TSPEI PG DIN 7991 CI 10.9 M 12 x 30 Z.Bianca	TSPEI PG screw DIN 7991 CI 10.9 M12 x 30 Z. white
BV230	BV023000	NR	Vite TE flangiata Tutto Filetto PG DIN 6921 CI 8.8 M 5 x 12 Zinconickel nero +sigillante	Flange Screw All Thread DIN 6921 PG CI 8.8 M 5 x 12 Zinconickel black +sealant
BV231	BV023100	NR	Vite TE flangiata Tutto Filetto PG DIN 6921 CI 8.8 M 6 x 16 Zinconickel nero +sigillante	Flange Screw All Thread DIN 6921 PG CI 8.8 M 6 x 16 Zinconickel black +sealant
BV232	BV023200	NR	Vite TE Tutto Filetto PG DIN 933 CI 8.8 M 5 x 25 Z.D.Bianca	Screw All Thread DIN 933 PG CI 8.8 M 5 x 25 ZD white
BV233	BV023300	NR	Vite TE Tutto Filetto PG DIN 933 CI 8.8 M 8 x 130 Z.D.Bianca	Screw All Thread DIN 933 PG CI 8.8 M 8 x 130 ZD white
BV234	BV023400	NR	Vite TBEI PG ISO 7380 CI 10.9 M 10 X 30 Z.Bianca	Hex socket screw ISO 7380 PG CI 10.9 M 10 X 30 Z. white
BV235	BV023500	NR	Vite TE Tutto Filetto PG DIN 933 CI 10.9 M 16 x 35 Z.D.Bianca	Screw All Thread DIN 933 PG CI 10.9 M 16 x 35 ZD white
BV236	BV023600	NR	Vite TE Parziale Filetto PG DIN 931 CI 8.8 M 6 x 45 Z.Bianca	Screw Partial Thread DIN 931 PG CI 8.8 M 6 x 45 Z. white
BV237	BV023700	NR	Vite TE Tutto Filetto PG DIN 933 CI 10.9 M 12 x 30 Z.D.Bianca	Screw All Thread DIN 933 PG CI 10.9 M 12 x 30 ZD white



POS	Codice	U.M.	 Descrizione	 Description
BV238	BV023800	NR	Vite TE Parziale Filetto PG DIN 931 CI 8.8 M 16 x 90 Z.Bianca	Screw Partial Thread DIN 931 PG CI 8.8 M 16 x 90 Z. white
BV239	BV023900	NR	Vite TE Parziale Filetto PG DIN 931 CI 8.8 M 12 x 65 Z.Bianca	Screw Partial Thread DIN 931 PG CI 8.8 M 12 x 65 Z. white
BV240	BV024000	NR	Vite TC Croce PG DIN 7985 CI 4.8 M 5 x 20 Z.Bianca	Screw DIN 7985 CI 4.8 M 5 x 20
BV241	BV024100	NR	Vite TSPEI PG DIN 7991 CI 10.9 M 10 x 35 Z.Bianca	TSPEI PG screw DIN 7991 CI 10.9 M 10 x 35 Z. white
BV242	BV024200	NR	Vite TSPEI PG DIN 7991 CI 10.9 M 6 x 12 Z.Bianca	TSPEI PG screw DIN 7991 CI 10.9 M 6 x 12 Z. white
BV243	BV024300	NR	Vite TE Parziale Filetto PG DIN 931 CI 8.8 M 12 x 150 Z.Bianca	Screw Partial Thread DIN 931 PG CI 8.8 M 12 x 150 Z. white
BV244	BV024400	NR	Vite TCEI PG DIN 912 CI 8.8 M5 x 50 ZINGATA BIANCA	Screw DIN 912 CI 8.8 M5 x 50
BV245	BV024500	NR	Vite TE Parziale Filetto PG DIN 931 CI 8.8 M 8 x 110 Z.Bianca	Screw Partial Thread DIN 931 PG CI 8.8 M 8 x 110 Z. white
BV246	BV024600	NR	Vite TE Parziale Filetto PG DIN 931 CI 8.8 M 8 x 40 Z.Bianca	Screw Partial Thread DIN 931 PG CI 8.8 M 8 x 40 Z. white
BV247	BV024700	NR	Vite TE Tutto Filetto PG DIN 933 CI 8.8 M 5 x 50 Z.D.Bianca	Screw All Thread DIN 933 PG CI 8.8 M 5 x 50 ZD white
BV248	BV024800	NR	Vite TCEI PG DIN 912 CI 8.8 M5 x 18 Z. BIANCA	Screw DIN 912 CI 8.8 M5 x 18 Z. WITHE
BV249	BV024900	NR	Vite TSPEI PG DIN 7991 CI 10.9 M 5 x 65 Z.Bianca	TSPEI PG screw DIN 7991 CI 10.9 M 5 x 65 Z. white
BV251	BV025100	NR	Vite TSPEI PG DIN 7991 CI 10.9 M 8 x 35 Z.Bianca	TSPEI PG screw DIN 7991 CI 10.9 M 8 x 35 Z. white
BV252	BV025200	NR	Vite TE Tutto Filetto PG DIN 933 CI 10.9 M 12 x 40 Z.D.Bianca	Screw All Thread DIN 933 PG CI 10.9 M 12 x 40 ZD white
BV253	BV025300	NR	Vite TBEI PG ISO 7380 M 6 x 55 Z.Bianca	Hex socket screw ISO 7380 PG M 6 x 55 Z. white
BV254	BV025400	NR	Vite TE Tutto Filetto PG DIN 933 CI 10.9 M 10 x 35 Z.D.Bianca	Screw All Thread DIN 933 PG CI 10.9 M 10 x 35 ZD white

POS	Codice	U.M.	 Descrizione	 Description
BV255	BV025500	NR	Vite TE Tutto Filetto PG DIN 933 CI 12.9 M 14 x 55 Z.D.Bianca	Screw All Thread DIN 933 PG CI 12.9 M 14 x 55 ZD white
BV256	BV025600	NR	Vite Testa Svasata Croce Autofilettante 6 x25	Screw Head Cross Countersunk Self Tapping 6 x 25
BV257	BV025700	NR	Vite TE Tutto Filetto PG DIN 933 CI 8.8 M14 x 30 Z.Bianca	Screw All Thread DIN 933 PG CI 8.8 M14 x 30 Z. white
BV258	BV025800	NR	Vite TE Tutto Filetto PG DIN 933 CI 10.9 M 12 x 35 Z.D.Bianca	Screw All Thread DIN 933 PG CI 10.9 M 12 x 35 ZD white
BV259	BV025900	NR	Vite TE Tutto Filetto PG DIN 933 CI 8.8 M 16 x 45 Z.Bianca	Screw All Thread DIN 933 PG CI 8.8 M16 x 45 Z. white
BV260	BV026000	NR	Vite TCEI PG DIN 912 CI 10.9 M 12 x 30 ZINCATA BIANCA	Screw DIN 912 CI 10.9 M 12 x 30
BV261	BV026100	NR	Vite TCEI PG DIN 912 CI 10.9 M 12 x 20 ZINCATA BIANCA	Screw DIN 912 CI 10.9 M 12 x 20
BV262	BV026200	NR	Vite TCEI PG DIN 912 CI 12.9 M14 x 35 GEOMET 321A	Screw DIN 912 CI 12.9 M14 x 35 GEOMET 321A
BV263	BV026300	NR	Vite TCEI PG DIN 912 CI 12.9 M14 x 3 GEOMET 321A	Screw DIN 912 CI 12.9 M14 x 3 GEOMET 321A
BV264	BV026400	NR	Vite TSPEI PG DIN 7991 CI 10.9 M 12 x 25 Z.Bianca	TSPEI PG screw DIN 7991 CI 10.9 M12 x 25 Z. white
BV265	BV026500	NR	Vite TE Parziale Filetto PG DIN 931 CI 10.9 M 16 x 180 GEOMET 321A	Screw Partial Thread DIN 931 PG CI 10.9 M 16 x 180 GEOMET 321A
BV266	BV026600	NR	Vite TE Tutto Filetto PG DIN 933 CI 8.8 M8 x 10 Z.Bianca	Screw All Thread DIN 933 PG CI 8.8 M8 x 10 Z. white
BV267	BV026700	NR	Vite TCEI PG DIN 912 CI 8.8 M 12 x 40	Screw DIN 912 CI 9.8 M 12 x 40
BV268	BV026800	NR	Vite TE Parziale Filetto PG DIN 931 CI 8.8 M 12 x 140 Z.Bianca	Screw Partial Thread DIN 931 PG CI 8.8 M 12 x 140 Z. white
BV269	BV026900	NR	Vite TC Croce PG DIN 7985 CI 4.8 M 6 x 25 Z.Bianca	Screw DIN 7985 CI 4.8 M 6 x 25
BV270	BV027000	NR	Vite TCEI PG DIN 912 CI 8.8 M 12 x 40	Screw DIN 912 CI 9.8 M 12 x 40
BV271	BV027100	NR	TCEI UNC ASME/ANSI B18.3 ASTM A 574 1/2 x 1"1/4 GEOMET	TCEI UNC ASME/ANSI B18.3 ASTM A 574 1/2 x 1"1/4 GEOMET

POS	Codice	U.M.	 Descrizione	 Description
BV272	BV027200	NR	TCEI UNC ASME/ANSI B18.3 ASTM A 574 1/4-20 x 1"1/2 GEOMET	TCEI UNC ASME/ANSI B18.3 ASTM A 574 1/4-20 x 1"1/2 GEOMET
BV273	BV027300	NR	Vite TE Parziale Filetto PG DIN 931 CI 8.8 M 12 x 70 Z.Bianca	Screw Partial Thread DIN 931 PG CI 8.8 M 12 x 70 Z. white
BV274	BV027400	NR	Vite TE Tutto Filetto PG DIN 933 CI 8.8 M 5 x 20 Z.D.Bianca	Screw All Thread DIN 933 PG CI 8.8 M 5 x 20 ZD white
BV275	BV027500	NR	Vite TSPEI PG DIN 7991 CI 10.9 M 6 x 70 Z.Bianca	TSPEI PG screw DIN 7991 CI 10.9 M 6 x 70 Z. white
BV276	BV027600	NR	Vite TCEI PG DIN 912 CI 8.8 M 5 x 14 Z.Bianca	Screw DIN 912 PG CI 8.8 M 5 x 14 Z. white
BV277	BV027700	NR	Vite TBEI PG ISO 7380 CI 10.9 M 10 x 35 Z.Bianca	Hex socket screw ISO 7380 PG CI 10.9 M 10 x 35 Z. white
BV281	BV028100	NR	Vite TE Parziale Filetto PG DIN 931 CI 8.8 M 14 x 45 Z.Bianca	Screw Partial Thread DIN 931 PG CI 8.8 M 14 x 45 Z. white



POS	Codice	U.M.	 Descrizione	 Description
RB1	RB000100	NR	DADO PER OGIVA Ø=12	NUT FOR OGIVA Ø = 12
RD1	RD000100	NR	RACCORDO CORPO A "T" EO F(DKOL)-M-M 8L	FITTING BODY A "T" EO F (DKOL) M-M-8L
RD2	RD000200	NR	RACCORDO CORPO A "T" EO F(DKOL)-M-M 10L	FITTING BODY A "T" EO F (DKOL) M-M-10L
RD3	RD000300	NR	RACCORDO CORPO A "T" EO F(DKOL)-M-M 12L	FITTING BODY A "T" EO F (DKOL) M-M-12L
RD4	RD000400	NR	RACCORDO CORPO A "T" EO F(DKOL)-M-M 15L	FITTING BODY A "T" EO F (DKOL) M-M-15L
RD5	RD000500	NR	RACCORDO CORPO A "T" EO M-F(DKOL)-M 10L	FITTING BODY A "T" EO M-F (DKOL) M-10L
RD6	RD000600	NR	RACCORDO CORPO A "T" EO M-F(DKOL)-M 12L	FITTING BODY A "T" EO M-F (DKOL) M-12L
RD7	RD000700	NR	RACCORDO CORPO A "T" EO 8L M 14*1.5	FITTING BODY A "T" EO 8L M 14 * 1.5
RD8	RD000800	NR	RACCORDO CORPO A "T" EO 10L M 16*1.5	FITTING BODY A "T" M 10L EO 16 * 1.5
RD9	RD000900	NR	RACCORDO CORPO A "T" EO 28L M 36*2	FITTING BODY A "T" M 28L EO 36 * 2
RD10	RD001000	NR	RACCORDO CORPO A "T" EO 28L M 36*2	FITTING BODY A "T" EO M-F (DKOL) M-10L
RD11	RD001100	NR	RACCORDO CORPO A "T" EO M-F(DKOL)-M 10L	FITTING BODY A "T" EO M-F (DKOL) M-10L
RD12	RD001200	NR	ADATTATORE "T" GAS M-FG-M 1/4 1/4 1/4	ADAPTOR
RG1	RG000100	NR	RACCORDO CORPO A GOMITO 10L MASCH.-FEMM. DKOL	ELBOW FITTING BODY 10L Masch.-FEMM. DKOL
RG2	RG000200	NR	RACCORDO CORPO A GOMITO 12L MASCH.-FEMM. DKOL	ELBOW FITTING BODY 12L Masch.-FEMM. DKOL
RG3	RG000300	NR	RACCORDO CORPO A GOMITO 20S MASCHIO-FEMMINA DKOS	20S BODY FITTING ELBOW MALE-FEMALE DKOS
RG4	RG000400	NR	RACCORDO CORPO A GOMITO 28L MASCHIO-FEMMINA DKOL	28L BODY FITTING ELBOW MALE-FEMALE DKOL

POS	Codice	U.M.	 Descrizione	 Description
RG5	RG000500	NR	RACCORDO A L MASCHIO-FEMMINA 1/8	BODY 90 ° M / F 1/8 "
RG6	RG000600	NR	ADATTATORE 90° BSPP M-FG 1/4	ADAPTOR
RN1	RN000100	NR	RACCORDO CORPO D'ESTREMITA' TENUTA ED 8L * 3/8 GAS *K*	END FITTING WITH SEAL ED 8L * 3/8 GAS * K *
RN2	RN000200	NR	RACCORDO CORPO D'ESTREMITA' TENUTA ED 12L * 3/8 GAS *K*	END FITTING WITH SEAL ED 12L * 3/8 GAS * K *
RN3	RN000300	NR	RACCORDO CORPO D'ESTREMITA' TENUTA ED 10L * 3/8 GAS *K*	FITTING END OF BODY 'AND SEAL 10L * 3/8 GAS * K *
RN4	RN000400	NR	RACCORDO CORPO D'ESTREMITA' TENUTA ED 8L * 1/4 GAS *K*	END FITTING WITH SEAL ED 8L * 1/4 GAS * K *
RN5	RN000500	NR	RACCORDO CORPO D'ESTREMITA'TENUTA ED 10L * 1/4 GAS *K*	FITTING END OF BODY 'AND SEAL 10L * 1/4 GAS * K *
RN6	RN000600	NR	RACCORDO CORPO D'ESTREMITA' TENUTA ED 12L * 1/4 GAS	FITTING END OF BODY 'AND SEAL 12L * 1/4 GAS
RN7	RN000700	NR	RACCORDO NIPLES GAS CON.- GAS CON. 1/4" * 1/4"	FITTING
RN8	RN000800	NR	RACCORDO CORPO D'ESTREMITA' TENUTA ED 15L * 1/2 GAS *K*	END FITTING WITH SEAL ED 15L * 1/2 * K * GAS
RN9	RN000900	NR	RACCORDO CORPO D'ESTREMITA' TENUTA ED 10L * 1/2 GAS *K*	FITTING END OF BODY 'AND SEAL 10L * 1/2 * K * GAS
RN10	RN001000	NR	RACCORDO CORPO D'ESTREMITA' TENUTA ED 15L * 3/4 GAS *K*	END FITTING WITH SEAL ED 15L * 3/4 GAS * K *
RN11	RN001100	NR	RACCORDO CORPO D'ESTREMITA' TENUTA ED 12L * 1/2 GAS *K*	END FITTING WITH SEAL ED 12L * 1/2 GAS * K *
RN12	RN001200	NR	RACCORDO CORPO D'ESTR. TENUTA ED 8L * 1/2 GAS	END FITTING WITH SEAL ED 8L * 1/2 GAS
RN13	RN001300	NR	RACCORDO CORPO D'ESTR. TENUTA ED 8L * 3/4 GAS	CONNECTOR BODY OF EXTR. SEAL AND 8L * 3/4 GAS
RN14	RN001400	NR	RACCORDO CORPO D'ESTR. TENUTA ED 12L * 3/4 GAS	CONNECTOR BODY OF EXTR. SEAL AND 12L * 3/4 GAS

POS	Codice	U.M.	 Descrizione	 Description
RN15	RN001500	NR	RACCORDO CORPO D'ESTR.TENUTA ED 15L * 3/8 GAS	END FITTING WITH SEAL ED 15L * 3/8 GAS
RN16	RN001600	NR	RACCORDO CORPO D'ESTR.TENUTA ED 22L * 3/4 GAS	END FITTING WITH SEAL ED 22L * 3/4 GAS
RN17	RN001700	NR	RACCORDO CORPO D'ESTR. TENUTA ED 28L * 3/4" GAS	END FITTING WITH SEAL ED 28L * 3/4 BSP
RN18	RN001800	NR	RACCORDO CORPO D'ESTR. TENUTA ED 20S * 3/4 GAS	CONNECTOR BODY OF EXTR. SEAL AND 20S * 3/4 GAS
RN19	RN001900	NR	RACCORDO CORPO D'ESTREMITA' 8L * M 12X1.5 ED	END FITTING 8L * M 12x1.5 ED
RN20	RN002000	NR	RACCORDO CORPO D'ESTREMITA' 8L * M 14X1.5 ED	FITTING END OF BODY 'AND 8L * M 14x1.5
RN21	RN002100	NR	RACCORDO CORPO D'ESTREMITA' 10L * M 18X1.5 ED	END FITTING 10L * M 18x1.5
RN22	RN002200	NR	RACCORDO CORPO D'ESTR. TENUTA ED 15L * M 18X1.5	CONNECTOR BODY OF EXTR. SEAL AND 15L * M 18x1.5
RN23	RN002300	NR	RACCORDO CORPO D'ESTR. TENUTA ED 15L * M 22X1.5	END FITTING WIHT SEAL ED 15L * M 22x1.5
RN24	RN002400	NR	RACCORDO CORPO D'ESTR. TENUTA ED 22L * M26X1.5	CONNECTOR BODY OF EXTR. SEAL AND 22L * M26x1.5
RN25	RN002500	NR	RACCORDO CORPO D'ESTR. TENUTA ED 20S * M27X2	CONNECTOR BODY OF EXTR. SEAL AND 20S * M27X2
RN26	RN002600	NR	RACCORDO CORPO D'ESTR. 8L * 9/16-18 UNF-2A	END FITTING 8L * 9/16-18 UNF-2A
RN27	RN002700	NR	RACCORDO CORPO D'ESTR. 12L * 3/4 -16 UNF-2A	END FITTING 12L * 3/4 -16 UNF-2A
RN28	RN002800	NR	RACCORDO CORPO D'ESTR. 20S * 1.5/16 -12 UN-2A	END FITTING 20S * 1.5/16 -12 UN-2A
RN29	RN002900	NR	RACCORDO CORPO D'ESTR. TENUTA ED 22L * M26X1.5	END FITTING WITH SEAL ED 22L * M26x1.5
RN30	RN003000	NR	RACCORDO CORPO D'ESTR. TENUTA ED 22L * M26X1.5	END FITTING WITH SEAL ED 22L * M26x1.5
RN31	RN003100	NR	RACCORDO CORPO D'ESTREMITA' TENUTA ED 6L * 1/4 GAS *K*	END FITTING WITH SEAL 1/4 BSPP 6L

POS	Codice	U.M.	 Descrizione	 Description
RN32	RN003200	NR	RACCORDO CORPO D'ESTREMITA' TENUTA ED 8L * 3/8 GAS *K*	END FITTING WITH SEAL ED 8L * 3/8 GAS * K *
RN33	RN003300	NR	NIPPLES 1/8" JIS 1/8"GAS	CAP
RN34	RN003400	NR	NIPPLES 1/4" JIS 1/4"GAS	CAP
RN35	RN003500	NR	NIPPLES 3/8" JIS 1/4"GAS	CAP
RN36	RN003600	NR	NIPPLES 3/8" JIS 1/4"GAS	CAP
RO1	RO000100	NR	OGIVA PER TUBO Ø=12	OGIVE FOR TUBE Ø = 12
RR1	RR000100	NR	RONDELLA RAME 1/4	COPPER WASHER 1/4
RR2	RR000200	NR	RONDELLA BONDED GAS 3/8" *K*	BONDED WASHER GAS 3/8 " * K *
RR3	RR000300	NR	RONDELLA BONDED METRICA 12 *K*	METRIC BONDED WASHER 12 * K *
RR4	RR000400	NR	RONDELLA BONDED GAS 1/4" *K*	BONDED WASHER GAS 1/4 " * K *
RR5	RR000500	NR	RONDELLA BONDED GAS 1/2" *K*	BONDED WASHER GAS 1/2 " * K *
RR6	RR000600	NR	RONDELLA RAME 3/8	COPPER WASHER 3/8
RR7	RR000700	NR	RONDELLA BONDED GAS 1/8" *K*	BONDED WASHER GAS 1/8 " * K *
RR8	RR000800	NR	RONDELLA BONDED GAS 1" *K*	BONDED WASHER GAS 1 " * K *
RR9	RR000900	NR	RONDELLA BONDED GAS 3/4" *K*	BONDED WASHER GAS 3/4 " * K *
RR10	RR001000	NR	RONDELLA BONDED GAS 1.1/4"	BONDED WASHER GAS 1.1 / 4 "
RR11	RR001100	NR	RONDELLA RAME M10	COPPER WASHER M10
RR12	RR001200	NR	RONDELLA RAME 1/2	COPPER WASHER 1/2

POS	Codice	U.M.	 Descrizione	 Description
RR13	RR001300	NR	RONDELLA BONDED M12	BONDED WASHER M12
RS1	RS000100	NR	COPPIA SEMIFLANGE SAE 6000 3/4"	PAIR 6000 SAE flange halves 3/4 "
RS2	RS000200	NR	RACC.M 20S(M30x2) - ED M 1"5/16 UNF H=33	FITTING M 20S (M30x2) - ED M 1 "5/16 UNF H = 33
RS3	RS000300	NR	RIDUZIONE M-F GAS 1" * 1/2"	REDUCING GAS M-F 1 "*" 1/2"
RS4	RS000400	NR	RACCORDO COLONNETTA M15L - 3/8" GAS H=50	COLUMN CONNECTION M15L - 3/8 "GAS H = 50
RS5	RS000500	NR	RACCORDO COLONNETTA M15L - 3/8" GAS H=96	COLUMN CONNECTION M15L - 3/8 "GAS H = 96
RS6	RS000600	NR	CODOLO M1/4" ED X FG 8L (M14X1.5)	FITTING M1 / 4 "X AND FG 8L (M14X1.5)
RS7	RS000700	NR	RIDUZIONE M-F GAS 1" * 1/2"	REDUCING GAS M-F 1 "*" 1/2"
RS8	RS000800	NR	RACCORDO CODOLO D' ESTR. FEM. DKO 12I*3/8 GAS ED	END FITTING FEM. DKO 12I*3/8 GAS ED
RS9	RS000900	NR	MANICOTTO ARIA 1/8-1/8	AIR MANIFOLD 1/8-1/8
RS10	RS001000	NR	RIDUZIONE M-F GAS 3/8" JIS 1/8" BSPP	REDUCING GAS M-F 3/8" JIS 1/8" BSPP
RS11	RS001100	NR	RACCORDO M-M 15L	FITTING M-M 15L
RS12	RS001200	NR	RACCORDO NIPLES GAS CON.- GAS CON.1/2"1/2"	FITTING 1/2" - 1/2"
RT1	RT000100	NR	TAPPO MASCHIO TE GAS 3/8" SVASATO 60° *K*	SCREW EYE FOR GAS 1/2 "H = 50
RT2	RT000200	NR	TAPPO MASCHIO ESAGONO INTERNO GAS 1/4" SVASATO 60° *K*	MALE PLUG GAS INTERNAL HEX 1/4 "FLARE 60 ° * K *
RT3	RT000300	NR	TAPPO MASCHIO TE GAS 1/2" SVASATO 60° *K*	MALE PLUG TE GAS 1/2 "FLARE 60 ° * K *
RT4	RT000400	NR	TAPPO MASCHIO TE GAS 1/4" SVASATO 60° *K*	MALE PLUG TE GAS 1/4 "FLARE 60 ° * K *

POS	Codice	U.M.	 Descrizione	 Description
RT5	RT000500	NR	TAPPO MASCHIO ESAGONO INTERNO GAS 3/8" SVASATO 60° *K*	MALE PLUG GAS INTERNAL HEX 3/8 "FLARE 60 ° * K *
RT6	RT000600	NR	TAPPO MASCHIO ESAGONO INTERNO GAS 1" SVASATO 60° *K*	MALE PLUG GAS INTERNAL HEX 1 "FLARE 60 ° * K *
RT7	RT000700	NR	TAPPO MASCHIO TE GAS 1/8" SVASATO 60° *K*	MALE PLUG TE GAS 1/8 "FLARE 60 ° * K *
RT8	RT000800	NR	TAPPO MASCHIO TE GAS 1/4" JIS	MALE PLUG TE GAS 1/4 " JIS
RT9	RT000900	NR	TAPPOO FEMMINA COMPLETO 6L	COMPLETE 6L FEMALE CAP
RT10	RT001000	NR	TAPPOO FEMMINA COMPLETO 8L	COMPLETE 8L FEMALE CAP
RT11	RT001100	NR	Tappo cilindrico TCEI+guarnizione GAS CI 5.8 3/4 Z.Bianca	cylindrical socket head cap + seal GAS CI 5.8 3/4 Z. White
RT12	RT001200	NR	Tappo cilindrico TCEI+guarnizione GAS CI 5.8 1/2 Z.Bianca	cylindrical socket head cap + seal GAS CI 5.8 1/2 Z. White
RV1	RV000100	NR	VITE PER OCCHIO GAS 1/4" H=29 *K*	SCREW EYE FOR GAS 1/4 "H = 29 * K *
RV2	RV000200	NR	VITE PER OCCHIO DOPPIA GAS 3/8"	SCREW EYE DOUBLE FOR GAS 3/8 "
RV3	RV000300	NR	VITE PER OCCHIO GAS 1/2" H= 50	SCREW EYE FOR GAS 1/2 "H = 50
RV4	RV000400	NR	VITE PER OCCHIO DOPPIA GAS 1/4"	DOUBLE EYE SCREW FOR GAS 1/4"
RV5	RV000500	NR	VITE PER OCCHIO GAS 3/8"	SCREW EYE FOR GAS 3/8"
RV6	RV000600	NR	VITE PER OCCHIO GAS 1/8"	SCREW EYE FOR GAS 1/8"



An Oshkosh Corporation Company

JLG Industries, Inc.
1 JLG Drive
McConnellsburg PA. 17233-9533
USA

(717) 485-5161 (Corporate)
 (800) 544-5438 (Service)
 (717) 485-6417
www.jlg.com

JLG Worldwide Locations

JLG Industries
358 Park Road
Regents Park
NSW 2143
Sydney 2143
Australia
 +6 (12) 87186300
 +6 (12) 65813058
Email: techservicesauc@jlg.com

JLG Ground Support Oude
Bunders 1034
Breitwaterstraat 12A
3630 Maasmechelen
Belgium
 +32 (0) 89 84 82 26
Email: emeaservice@jlg.com

JLG Latino Americana LTDA
Rua Antonia Martins Luiz, 580
Distrito Industrial Joao Narezzi
Indaiatuba-SP 13347-404
Brasil
 +55 (19) 3936 7664 (Parts)
 +55(19)3936 9049 (Service)
Email: comercialpecas@jlg.com
Email: servic@jlg.com

Oshkosh-JLG (Tianjin) Equipment
Technology LTD
Shanghai Branch
No 465 Xiao Nan Road
Feng Xian District
Shanghai 201204
China
 +86 (21) 800 819 0050

JLG Industries Dubai
Jafza View
PO Box 262728, LB 19
20th Floor, Office 05
Jebel Ali, Dubai
 +971 (0) 4 884 1131
 +971 (0) 4 884 7683
Email: emeaservice@jlg.com

JLG France SAS
Z.I. Guillaume Mon Amy
30204 Fauillet
47400 Tonniens
France
 +33 (0) 553 84 85 86
 +33 (0) 553 84 85 74
Email: pieces@jlg.com

JLG Deutschland GmbH
Max Planck Str. 21
27721 Ritterhude - Ihlpohl
Germany
 +49 (0) 421 69350-0
 +49 (0) 421 69350-45
Email: german-parts@jlg.com

JLG Equipment Services Ltd.
Rm 1107 Landmark North
39 Lung Sum Avenue
Sheung Shui N. T.
Hong Kong
 + (852) 2639 5783
 + (852) 2639 5797

JLG Industries (Italia) S.R.L.
Via Po. 22
20010 Pregnana Milanese (MI)
Italy
 +39 (0) 2 9359 5210
 +39 (0) 2 9359 5211
Email: ricambi@jlg.com

JLG EMEA B.V.
Polaris Avenue 63
2132 JH Hoofddorf
The Netherlands
 +31 (0) 23 565 5665
Email: emeaservice@jlg.com

JLG NZ Access Equipment & Services
2B Fisher Crescent
Mt Wellington 1060
Auckland, New Zealand
 +6 (12) 87186300
 +6 (12) 65813058
Email: techservicesaus@jlg.com

JLG Industries
Vahutinskoe shosse 24b.
Khimki
Moscow Region 141400
Russia Federation
 +7 (499) 922 06 99
 +7 (499) 922 06 99

Oshkosh-JLG Singapore Technology
Equipment Pte Ltd.
35 Tuas Avenue 2
Jurong Industrial Estate
Singapore 639454
 +65 6591 9030
 +65 6591 9045
Email: SEA@jlg.com

JLG Iberica S.L.
Trapadella, 2
Pol. Ind. Castellbisbal Sur
08755 Castellbisbal Barcelona
Spain
 +34 (0) 93 772 47 00
 +34 (0) 93 771 1762
Email: parts_iberica@jlg.com

JLG Industries (UK) Ltd.
Bentley House
Bentley Avenue
Middleton, Greater Manchester
M24 2GP
United Kingdom
 +44 (0) 161 654 1000
 +44 (0) 161 654 1003
Email: ukparts@jlg.com

JLG Sverige AB
Enkopingsvagen 150
176 27 Jarfalla
Sweden
 +46 (0) 8 506 595 00
 +46 (0) 8 506 595 27
Email: nordicsupport@jlg.com