

OPERATORS & SAFETY SERVICE & MAINTENANCE ILLUSTRATED PARTS MANUAL

WORLD HEADQUARTERS

JLG INDUSTRIES, INC.
JLG Drive
McConnellsburg, PA 17233-9502
USA
Telephone (717) 485-5161
Fax (717) 485-6417

JAPAN SPEC

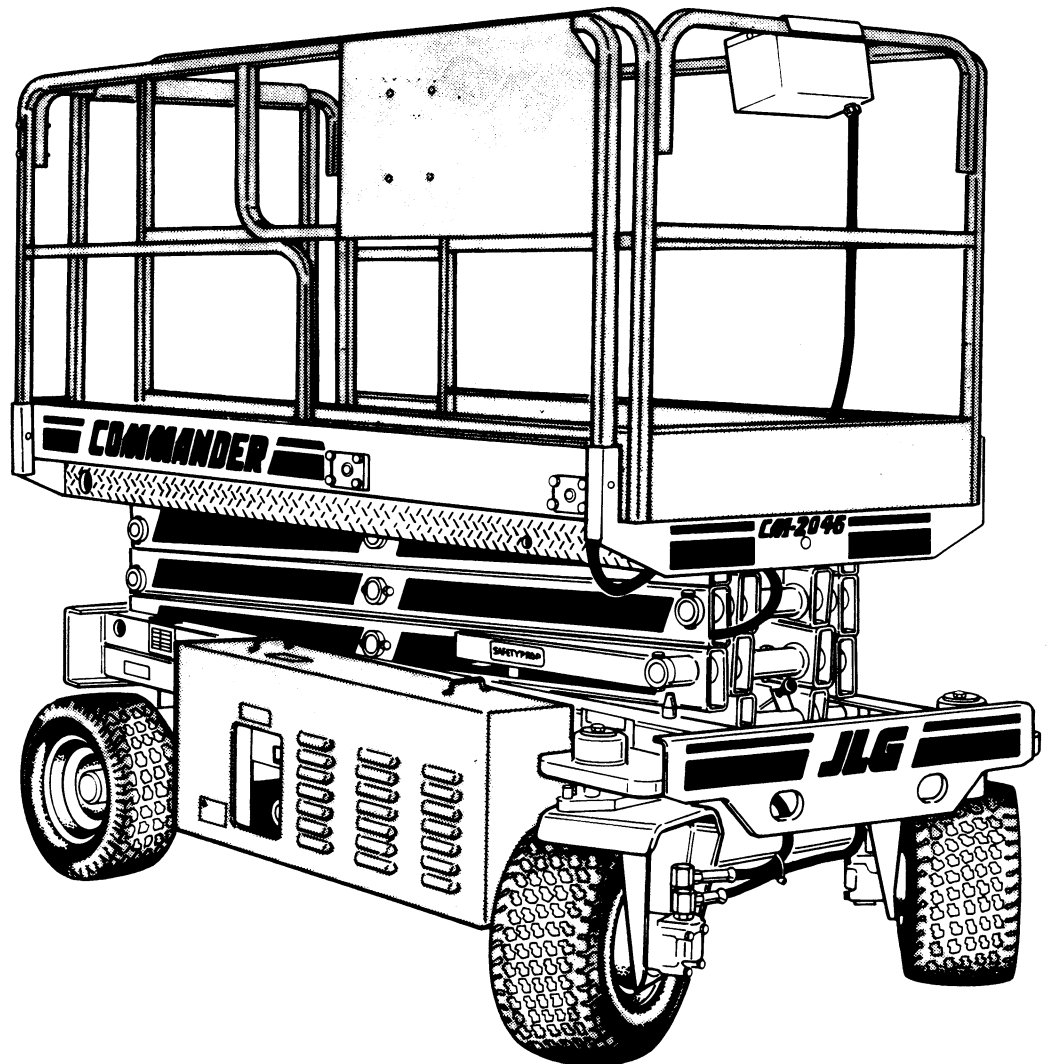

MODELS

CM1432
CM1432 PLUS
CM1732
CM2033
CM2046
CM2546
CM2558



CHANGE 2 DECEMBER 1995
15 DECEMBER 1992

PRINTED IN U.S.A.

3120587

FOREWORD

The purpose of this manual is to provide the customer with the operating procedures essential for the promotion of proper machine operation for its intended purpose. It is important to over-stress proper usage. All information in this manual should be READ and UNDERSTOOD before any attempt is made to operate the machine. YOUR OPERATING MANUAL IS YOUR MOST IMPORTANT TOOL - Keep it with the machine.

SINCE THE MANUFACTURER HAS NO DIRECT CONTROL OVER MACHINE APPLICATION AND OPERATION, CONFORMANCE WITH GOOD SAFETY PRACTICE IN THIS AREA IS THE RESPONSIBILITY OF THE USER AND HIS OPERATING PERSONNEL.

ALL PROCEDURES HEREIN ARE BASED ON THE USE OF THE MACHINE UNDER PROPER OPERATING CONDITIONS, WITH NO DEVIATIONS FROM THE ORIGINAL DESIGN. ALTERATION AND/OR MODIFICATION OF THE MACHINE IS STRICTLY FORBIDDEN WITHOUT WRITTEN APPROVAL FROM JLG INDUSTRIES, INC.

A MOST IMPORTANT FACT TO REMEMBER IS THAT ANY EQUIPMENT IS ONLY AS SAFE AS THOSE WHO OPERATE IT.

DANGER, WARNING, CAUTION, IMPORTANT, INSTRUCTIONS AND NOTE DEFINITIONS

Since safety of personnel and proper use of the machine are of primary concern, DANGER, WARNING, CAUTION, IMPORTANT, INSTRUCTIONS and NOTES are inserted throughout this manual to emphasize these areas. They are defined as follows:

DANGER

IF NOT CORRECTLY FOLLOWED THERE IS A HIGH PROBABILITY OF SERIOUS INJURY OR DEATH TO PERSONNEL.

WARNING or CAUTION

IF NOT CORRECTLY FOLLOWED THERE IS SOME POSSIBILITY OF SERIOUS INJURY OR DEATH TO PERSONNEL.



THE "SAFETY ALERT SYMBOL" IS USED TO CALL ATTENTION TO POTENTIAL HAZARDS WHICH MAY LEAD TO DEATH OR SERIOUS INJURY IF IGNORED.

IMPORTANT OR INSTRUCTIONS

DENOTES PROCEDURES ESSENTIAL TO SAFE OPERATION AND PREVENTION OF DAMAGE TO OR DESTRUCTION OF MACHINE.

Note

Provides information of special interest to illustrate the text.

All procedures herein are based on the use of the machine under proper operating conditions, with no deviations from original design intent ... as per OSHA regulations.

READ & HEED!

The ownership, use, service, and/or maintenance of this machine is subject to various federal, state and local laws and regulations. It is the responsibility of the owner/user to be knowledgeable of these laws and regulations and to comply with them. The most prevalent regulations of this type are the Federal OSHA Safety Regulations*. Listed below, in abbreviated form are some of the requirements of Federal OSHA regulations in effect as of the date of publication of this handbook.

The listing of these requirements shall not relieve the owner/user of the responsibility and obligation to determine all applicable laws and regulations and their exact wording and requirements, and to comply with the requirements. Nor shall the listing of these requirements constitute an assumption of responsibility of liability on the part of JLG Industries, Inc.

1. Only trained and authorized operators shall be permitted to operate the aerial lift.
2. A malfunctioning lift shall be shut down until repaired.
3. The controls shall be plainly marked as to their function.
4. The controls shall be tested each day prior to use to determine that they are in safe operating condition.
5. When applicable to local regulations or job site/employer safety rules, all personnel in the platform shall wear an approved safety belt with the lanyard attached to the platform attachment point.
6. Load limits specified by the manufacturer shall not be exceeded.
7. Instruction and warning placards must be legible.
8. Aerial lifts may be "field modified" for uses other than those intended by the manufacturer only if certified in writing by the manufacturer or an equivalent entity, such as a nationally recognized testing lab, to be in conformity to applicable OSHA safety regulations and to be at least as safe as it was prior to modification.
9. Aerial lifts shall not be used near electric power lines unless the lines have been deenergized or adequate clearance is maintained (see OSHA 20 CFR 1910.67 and 1926.400).
10. Employees using aerial lifts shall be instructed how to recognize and avoid unsafe conditions and hazards.
11. Ground controls shall not be operated unless permission has been obtained from personnel in the platform, except in case of an emergency.
12. Regular inspection of the job site and aerial lift shall be performed by competent persons.
13. Personnel shall always stand on the floor of the platform, not on boxes, planks, railing or other devices for a work position.

*Applicable Federal OSHA regulations, as of the date of publication of this manual include, but are not limited to, 29 CFR 1910.67, 29 CFR 1926.20, 29 CFR 1926.21, 29 CFR 1926.28, 29 CFR 1926.400 and 29 CFR 1926.556. Consult the current regulations for the exact wording and full text of the requirements and contact the closest Federal OSHA office for specific interpretations.

A. GENERAL.

1. This section contains the general safety precautions which must be observed during maintenance of the aerial platform. It is of utmost importance that maintenance personnel pay strict attention to these warnings and precautions to avoid possible injury to themselves or others or damage to the equipment. A maintenance program must be established by a qualified person and must be followed to ensure that the machine is safe to operate.

WARNING

MODIFICATION OF THE MACHINE WITHOUT CERTIFICATION BY A RESPONSIBLE AUTHORITY THAT THE MACHINE IS AT LEAST AS SAFE AS ORIGINALLY MANUFACTURED IS A SAFETY VIOLATION.

2. The specific precautions to be observed during machine maintenance are inserted at the appropriate point in the manual. These precautions are, for the most part, those that apply when servicing hydraulic and larger machine component parts.
3. Your safety, and that of others, is the first consideration when engaging in the maintenance of equipment. Always be conscious of weight.

Never attempt to move heavy parts without the aid of a mechanical device. Do not allow heavy objects to rest in an unstable position. When raising a portion of the equipment, ensure that adequate support is provided.

WARNING

SINCE THE MACHINE MANUFACTURER HAS NO DIRECT CONTROL OVER THE FIELD INSPECTION AND MAINTENANCE, SAFETY IN THIS AREA IS THE RESPONSIBILITY OF THE OWNER/OPERATOR.

B. HYDRAULIC SYSTEM SAFETY.

1. It should be particularly noted that the machines hydraulic systems operate at extremely high and potentially dangerous pressures. Every effort should be made to relieve any system pressure prior to disconnecting or removing any portion of the system.

2. Relieve system pressure by cycling the applicable control several times with the engine stopped and ignition on, to direct any line pressure back into the return line to the reservoir. Pressure feed lines to system components can then be disconnected with minimal fluid loss.

C. MAINTENANCE.**WARNING**

FAILURE TO COMPLY WITH SAFETY PRECAUTIONS LISTED IN THIS SECTION MAY RESULT IN MACHINE DAMAGE, PERSONNEL INJURY OR DEATH AND IS A SAFETY VIOLATION.

REMOVE ALL RINGS, WATCHES, AND JEWELRY WHEN PERFORMING ANY MAINTENANCE.

DO NOT WEAR LONG HAIR UNRESTRAINED, OR LOOSE FITTING CLOTHING AND NECKTIES WHICH ARE APT TO BECOME CAUGHT ON OR ENTANGLED IN EQUIPMENT.

OBSERVE AND OBEY ALL WARNINGS AND CAUTIONS ON MACHINE AND IN SERVICE MANUAL.

KEEP OIL, GREASE, WATER, ETC. WIPED FROM STANDING SURFACES AND HAND HOLDS.

NEVER WORK UNDER AN ELEVATED PLATFORM UNTIL SAFETY PROPS HAVE BEEN ENGAGED OR PLATFORM HAS BEEN SAFELY RESTRAINED FROM ANY MOVEMENT BY BLOCKING OR OVERHEAD SLING.

BEFORE MAKING ADJUSTMENTS, LUBRICATING OR PERFORMING ANY OTHER MAINTENANCE, SHUT OFF ALL POWER CONTROLS.

BATTERY SHOULD ALWAYS BE DISCONNECTED DURING REPLACEMENT OF ELECTRICAL COMPONENTS.

KEEP ALL SUPPORT EQUIPMENT AND ATTACHMENTS STOWED IN THEIR PROPER PLACE.

USE ONLY APPROVED, NONFLAMMABLE CLEANING SOLVENTS.

CM1432-2558
3120587 PARTS MANUAL
REVISION LOG

December 1992 - Original Issue

March 1993 - Revised

July 1994 - Revised

January 1995 - Change 1

Pages Affected:

Cover

Table of Contents - Page iii and Page iv

Section 10 - Pages 10-1 and 10-2

Section 11 - Table of Contents - Page 11-0-1

Section 11-1 - Pages 11-1-4, 11-1-5, 11-1-12 and 11-1-13

Section 11-2 - Pages 11-2-1, 11-2-4, 11-2-9, 11-2-19 to 11-2-23

Section 11-4 - Pages 11-4-7, 11-4-12, 11-4-13, 11-4-15, 11-4-19, 11-4-21 to 11-4-23

Section 11-6 - Pages 11-6-3, 11-6-5, 11-6-7 and 11-6-8

Section 11-7 - Pages 11-7-1, 11-7-5B, 11-7-10, 11-7-11

Section 11-8 - Pages 11-8-4 and 11-8-5

Section 12 - Page 12-1

Section 13 - Table of Contents - Page 13-0-1

Section 13-1 - Pages 13-1-13, 13-1-19 to 13-1-15

Section 13-2 - Pages 13-2-7, 13-2-11

Section 13-3 - Page 13-3-5

Section 13-4 - Pages 13-4-3 to 13-4-5, 13-4-7, 13-4-11, 13-4-13 to 13-4-15

Section 13-6 - Pages 13-6-3, 13-6-4

Section 13-7 - Pages 13-7-1, 13-7-5, 13-7-10, 13-7-11

Section 13-8 - Page 13-8-5

December 1995 - Change 2

Pages Affected:

Cover

Revision Log - Page c/d

Section 11-1 - Pages 11-1-3 to 11-1-5, 11-1-9 and 11-1-11 to 11-1-12

Section 11-2 - Pages 11-2-4 to 11-2-7, 11-2-11 and 11-2-15

Section 11-3 - Pages 11-3-3, 11-3-5, 11-3-7 and 11-3-8

Section 11-4 - Pages 11-4-5, 11-4-7, 11-4-13, 11-4-15 and 11-4-21 to 11-4-23

Section 11-5 - Page 11-5-9

Section 11-6 - Pages 11-6-5 and 11-6-8

Section 11-7 - Pages 11-7-2 to 11-7-9

Section 11-8 - Pages 11-8-2 to 11-8-4

Section 13-1 - Pages 13-1-3, 13-1-7 and 13-1-10

Section 13-2 - Pages 13-2-2, 13-2-5, 13-2-7 and 13-2-12

Section 13-3 - Pages 13-3-2, 13-3-3 and 13-3-5

Section 13-4 - Pages 13-4-3, 13-4-4, 13-4-7, 13-4-13 and 13-4-14

Section 13-5 - Page 13-5-9

Section 13-7 - Pages 13-7-2 to 13-7-9

Section 13-8 - Pages 13-8-2, 13-8-3 and 13-8-5

Change 1 c/d Blank

TABLE OF CONTENTS

SUBJECT - SECTION, PARAGRAPH	PAGE NO.
INTRODUCTION - OPERATION SAFETY PRECAUTIONS	a
INTRODUCTION - MAINTENANCE SAFETY PRECAUTIONS	b
TABLE OF CONTENTS	i
LIST OF ILLUSTRATIONS	iii
LIST OF TABLES	iv
 SECTION 1 — SAFETY PRECAUTIONS	
1-1. General	1-1
1-2. Driving/Towing/Carrying	1-1
1-3. Electrocution Hazard	1-2
1-4. Pre-Operational	1-3
1-5. Driving	1-4
1-6. Operation	1-5
1-7. Towing and Hauling	1-9
1-8. Maintenance	1-10
 SECTION 2 — PREPARATION AND INSPECTION	
2-1. General	2-1
2-2. Preparation For Use	2-1
2-3. Delivery and Periodic Inspection	2-1
2-4. Daily Walk-Around Inspection	2-2
2-5. Daily Functional Check	2-2
2-6. Torque Requirements	2-3
2-7. Battery Charging	2-3
 SECTION 3 — USER RESPONSIBILITIES AND MACHINE CONTROL	
3-1. General	3-1
3-2. Personnel Training	3-1
3-3. Operating Characteristics and Limitations	3-1
3-4. Controls and Indicators	3-2
 SECTION 4 — MACHINE OPERATION	
4-1. Description	4-1
4-2. General	4-1
4-3. Motor Operation	4-1
4-4. Raising and Lowering (Lifting)	4-2
4-5. Platform Extension (If Equipped)	4-2
4-6. Steering	4-3
4-7. Traveling (Driving)	4-3
4-8. Parking and Stowing	4-4
4-9. Platform Loading	4-4
4-10. Safety Prop	4-5
4-11. Tie Down and Lifting	4-5
4-12. Towing	4-5
 SECTION 5 — OPTIONAL EQUIPMENT	
5-1. PQ Controller	5-1
5-2. Horn	5-1
5-3. Travel Alarm	5-1
5-4. Motion Alarm	5-1
5-5. Descent Alarm	5-1

TABLE OF CONTENTS (cont.)

SUBJECT-SECTION, PARAGRAPH	PAGE NO.
SECTION 5 — OPTIONAL EQUIPMENT (cont.)	
5-6. Platform Receptacle	5-1
5-7. Platform Work Lights	5-1
5-8. Non-Marking Tires	5-1
5-9. Rotating Beacon	5-1
5-10. High Output Batteries (CM2046, CM2546 and CM2558 Only)	5-1
5-11. Battery Condition Indicator	5-1
5-12. Fold-Down Hand Rails	5-1
5-13. Control Box Cover	5-1
5-14. Platform Access Door	5-1
5-15. Lifting Lugs	5-1
SECTION 6 — EMERGENCY PROCEDURES	
6-1. General	6-1
6-2. Emergency Towing Procedures	6-1
6-3. Emergency Controls and Their Locations	6-1
6-4. Emergency Operation	6-1
6-5. Incident Notifications	6-2
SECTION 7 — SPECIFICATIONS	
7-1. Capacities	7-1
7-2. Component Data	7-1
7-3. Performance Data	7-1
7-4. Torque Requirements	7-2
7-5. Lubrication	7-2
7-6. Cylinder Specifications	7-2
7-7. Pressure Settings	7-6
7-8. Serial Number Locations	7-6
7-9. Limit Switches	7-6
7-10. Major Component Weights	7-6
SECTION 8 — PROCEDURES	
8-1. General	8-1
8-2. Servicing and Maintenance Guidelines	8-1
8-3. Lubrication Information	8-2
8-4. Cylinders - Theory of Operation	8-3
8-5. Valves - Theory of Operation	8-3
8-6. Component Functional Description	8-4
8-7. Wear Pads	8-4
8-8. Cylinder Checking Procedures	8-5
8-9. Cylinder Removal and Installation	8-5
8-10. Cylinder Repair (Except Brake Cylinder)	8-6
8-11. Brake Cylinder Repair	8-8
8-12. Tilt Alarm Switch	8-10
8-13. Limit Switch Adjustment	8-11
8-14. Pressure Setting Procedures	8-11
8-15. Preventive Maintenance and Inspection Schedule	8-14
SECTION 9 — TROUBLESHOOTING	
9-1. General	9-1
9-2. Troubleshooting Information	9-1
9-3. Hydraulic Circuit Checks	9-1

Updated 02/93

TABLE OF CONTENTS (cont.)

SUBJECT-SECTION, PARAGRAPH	PAGE NO.
SECTION 10 — RECOMMENDED SPARE PARTS LIST - CM2033/CM2046/CM20546/CM2558	
Recommended Spare Parts List - CM2033/CM2046/CM2546/CM2558	10-1
SECTION 11 — ILLUSTRATED PARTS LIST - CM2033/CM2046/CM2546/CM2558	
Table of Contents.	11-0-1
SECTION 12 — RECOMMENDED SPARE PARTS LIST - CM1432	
Recommended Spare Parts List - CM1432.	12-1
SECTION 13 — ILLUSTRATED PARTS LIST - CM1432/CM1432 PLUS/CM1732	
Table of Contents.	13-0-1

LIST OF ILLUSTRATIONS

FIGURE NO.	TITLE	PAGE NO.
2-1	Daily Walk-Around Inspection - CM1432.	2-4
2-2	Daily Walk-Around Inspection - CM2033/CM2046/CM2546/CM2558	2-6
3-1	Ground Control Station - CM1432	3-4
3-2	Ground Control Station - CM2033/CM2046/CM2546/CM2558	3-4
3-2	Platform Control Station w/o PQ Controller - All Models (Machines Built Before August 1992)	3-5
3-3	Platform Control Station w/PQ Controller - All Models (Machines Built Before August 1992)	3-5
3-4	Platform Control Station w/o PQ Controller - All Models (Machines Built After August 1992)	3-6
3-5	Platform Control Station w/PQ Controller - All Models (Machines Built After August 1992)	3-6
4-1	Grade and Sideslope	4-3
7-1	Torque Chart	7-3
7-2	Lubrication Chart - CM1432.	7-4
7-3	Lubrication Chart - CM2033/CM2046/CM2546/CM2558	7-5
7-4	Serial Number Locations - CM1432	7-7
7-5	Serial Number Locations - CM2033/CM2046/CM2546/CM2558	7-8
8-1	Poly-Pak Seal Installation	8-7
8-2	Brake Cylinder Assembly.	8-9
8-3	Tilt Alarm Switch Leveling - Voltmeter Adjustment	8-11
8-4	Pressure Adjustment Locations - Proportional Valve	8-12
8-5	Pressure Adjustment Locations - Bang-Bang Valve	8-13
11-1-1	Frame, Steering and Drive Installation	11-1-2
11-1-2	Drive Motor Assemblies.	11-1-6
11-1-3	Rear Axle and Brake Installations	11-1-8
11-1-4	Frame Mounted Components Installation	11-1-10
11-2-1	Covers, Controls, Tank and Valves Installation.	11-2-2
11-2-2	Control Valve Assembly - Hydro-Air (Machines with Bang-Bang Drive).	11-2-8
11-2-3	Control Valve Assembly - Hydro-Air (Machines with Proportional Drive)	11-2-12
11-2-4	Batteries and Chargers Installation	11-2-16
11-2-5	Battery Charger Assembly (Prior to September 1994)	11-2-20
11-2-6	Battery Charger Assembly (September 1994 to Present).	11-2-22
11-3-1	Sizzor Arms Installation - CM2033 and CM2046	11-3-2
11-3-2	Sizzor Arms Installation - CM2546 and CM2558	11-3-4
11-4-1	Standard Handrails and Accessories Installation.	11-4-2

LIST OF ILLUSTRATIONS (cont.)

FIGURE NO.	TITLE	PAGE NO.
11-4-2	Optional Fold-Down Handrail Installation	11-4-8
11-4-3	Optional Extendable Deck Installation with Standard Handrails	11-4-12
11-4-4	Optional Extendable Deck Installation with Fold-Down Handrails	11-4-14
11-4-5	Steel Platform Console Box Assembly	11-4-16
11-4-6	Molded Platform Console Box Assembly	11-4-20
11-5-1	Brake Cylinder Assembly	11-5-2
11-5-2	Lift Cylinder Sub-Assembly	11-5-4
11-5-3	Steer Cylinder Assembly	11-5-8
11-6-1	Hydraulic Diagram - Bang-Bang Drive	11-6-2
11-6-2	Hydraulic Diagram - Proportional Drive	11-6-6
11-7-2	Electrical Diagram - Toggle Switch Drive	11-7-6
11-7-3	Electrical Diagram - PQ Controller Bang-Bang Drive	11-7-7
11-7-4	Electrical Diagram - PQ Controller Proportional Drive	11-7-8
11-7-5	Electrical Diagram - Circuit Cards	11-7-9
11-7-6	Main Electrical Connector and Tools	11-7-10
11-8-1	Decal Installation	11-8-2
13-1-1	Frame, Steering and Drive Installation	13-1-2
13-1-2	Drive Motor Assemblies	13-1-4
13-1-3	Rear Axle and Brake Installations	13-1-6
13-1-4	Frame Mounted Components Installation	13-1-8
13-1-5	Battery Charger Assembly (Prior to September 1994)	13-1-12
13-1-6	Battery Charger Assembly (September 1994 to Present)	13-1-14
13-2-1	Electrical Components Installation	13-2-2
13-2-2	Hydraulic Components and Covers Installation	13-2-6
13-2-3	Control Valve Assembly - Hydro-Air	13-2-10
13-3-1	Sizzor Arms Installation - CM1432 and CM1432 Plus	13-3-2
13-3-2	Sizzor Arms Installation - CM1732	13-3-4
13-4-1	Platform and Handrail Installation	13-4-2
13-4-2	Optional Platform Extension Installation	13-4-6
13-4-3	Steel Platform Console Box Assembly	13-4-8
13-4-4	Molded Platform Console Box Assembly	13-4-12
13-5-1	Brake Cylinder Assembly	13-5-2
13-5-2	Lift Cylinder Sub-Assembly	13-5-4
13-5-3	Steer Cylinder Assembly	13-5-8
13-6-1	Hydraulic Diagram - Standard	13-6-2
13-7-2	Electrical Diagram - Toggle Switch Drive	13-7-6
13-7-3	Electrical Diagram - PQ Controller Bang-Bang Drive	13-7-7
13-7-4	Electrical Diagram - Circuit Cards	13-7-8
13-7-5	Main Electrical Connector and Tools	13-7-10
13-8-1	Decals Installation - CM1432 and CM1432 Plus	13-8-2
13-8-2	Decals Installation - CM1732	13-8-6

LIST OF TABLES

TABLE NO.	TITLE	PAGE NO.
3-1	Control Panel Symbols	3-7
7-1	Hydraulic Oil	7-2
7-2	Lubrication Specifications	7-2
8-1	Cylinder Piston Nut Torque Specifications	8-8
8-2	Preventive Maintenance and Inspection	8-15
9-1	Elevation System Troubleshooting	9-2
9-2	Chassis Troubleshooting	9-4
9-3	Hydraulic System Troubleshooting	9-7
9-4	Electrical System Troubleshooting	9-8
11-7-1	Electrical Diagrams and Components Chart - CM2033/CM2046/CM2546/CM2558	11-7-2
13-7-1	Electrical Diagrams and Components Chart - CM1432/CM1432 Plus/CM1732	13-7-2

1-1. GENERAL.

- a. This section prescribes the proper and safe practices for major areas of machine usage which have been divided into three basic categories: Driving, Operation and Maintenance. In order to promote proper usage of the machine, it is mandatory that a daily routine be established based on instruction given in this section. A maintenance program must also be established by a qualified person and must be followed to ensure that the machine is safe to operate.
- b. The user/operator of the machine should not accept operating responsibility until this manual has been read and operation of the machine, under the supervision of an experienced and qualified operator, has been completed. If there is a question on application and/or operation, JLG Industries Product Safety and Reliability should be consulted.

WARNING

MODIFICATION OF THE MACHINE WITHOUT APPROVAL OF JLG INDUSTRIES, OR CERTIFICATION BY A NATIONALLY RECOGNIZED TESTING LAB TO BE IN CONFORMITY WITH APPLICABLE OSHA REGULATIONS, AND TO BE AT LEAST AS SAFE AS BEFORE MODIFICATION, IS PROHIBITED AND IS A VIOLATION OF OSHA RULES.

1-2. DRIVING/TOWING/CARRYING.

- a. Before driving the machine the user must be familiar with the drive, steer and stopping characteristics. This is especially important when driving in close quarters.
- b. The user should be familiar with the driving surface before driving. The surface should be firm and level and grades should not exceed the allowable grade, as indicated on the CAUTION placard at the platform control station.

Note

Remember that the key to safe and proper usage is common sense and its careful application.

- c. Standard machine is not equipped with provisions for towing. Refer to Section 6 for emergency towing procedures.

SPECIAL NOTE:

CERTAIN 'CARTOONS' IN THIS PUBLICATION SHOULD IN NO WAY BE CONSTRUED AS SHOWING THE PROPER USE OF THE MACHINES. THEY ARE INCLUDED TO PROVIDE VISUAL INDICATIONS OF INCORRECT EQUIPMENT OPERATION AND APPLICATION.

WARNING

FAILURE TO COMPLY WITH SAFETY PRECAUTIONS LISTED IN THIS SECTION AND ON MACHINE MAY RESULT IN MACHINE DAMAGE, PERSONNEL INJURY OR DEATH AND IS A SAFETY VIOLATION.

- d. Carrying or loading the unit should be accomplished using a forklift vehicle of suitable capacity with the forks being positioned correctly beneath the indicated areas on the lower side of the frame.

1-3. ELECTROCUTION HAZARD.

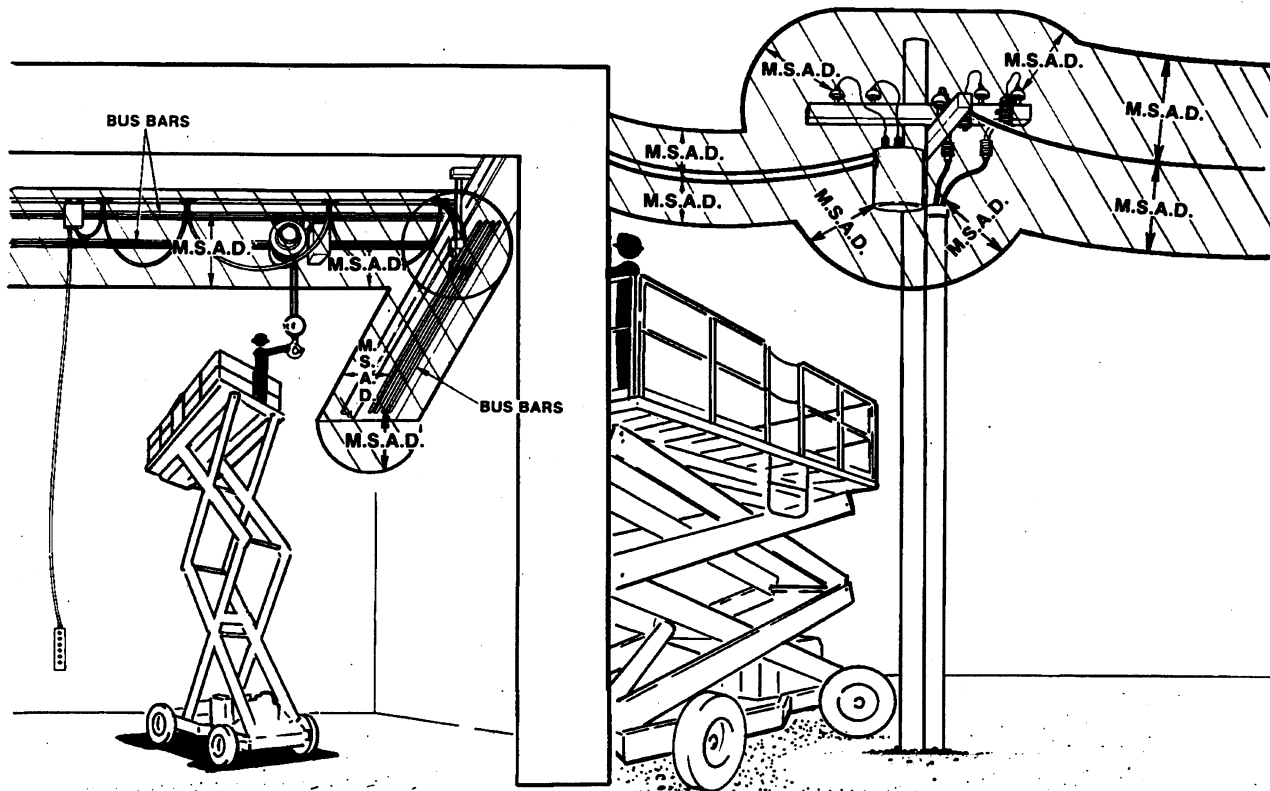

DENOTES PROHIBITED ZONE

M.S.A.D. = MINIMUM SAFE APPROACH DISTANCE
 (SEE TABLE BELOW)
 MAINTAIN M.S.A.D. FROM ALL
 OTHER CHARGED LINES AND PARTS
 AS WELL AS THOSE SHOWN.

Table

Minimum safe approach distances (M.S.A.D.) to energized (exposed or insulated) power lines and parts.

VOLTAGE RANGE (Phase to Phase)	MINIMUM SAFE APPROACH DISTANCE Feet (Meters)
0 to 300V	AVOID CONTACT
Over 300V to 50KV	10 (3)
Over 50KV to 200KV	15 (5)
Over 200KV to 350KV	20 (6)
Over 350KV to 500KV	25 (8)
Over 500KV to 750KV	35 (11)
Over 750KV to 1000KV	45 (14)

DANGER: DO NOT maneuver machine or personnel inside PROHIBITED ZONE.
 ASSUME all electrical parts and wiring are ENERGIZED unless known otherwise.

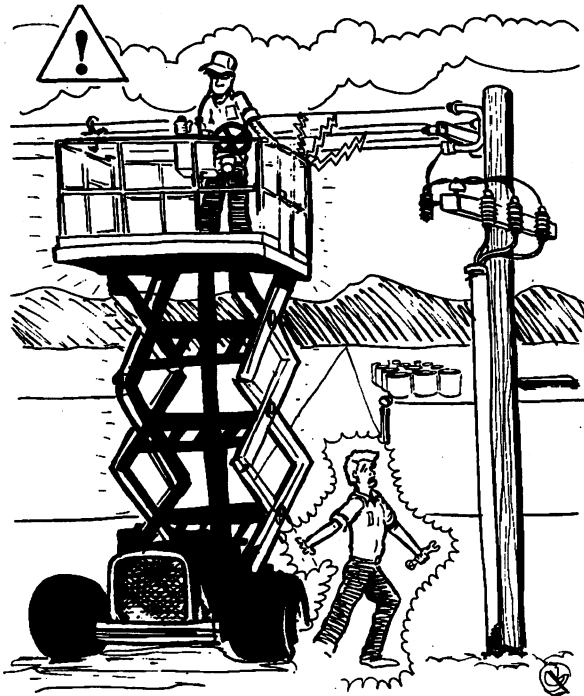

MAINTAIN A SAFE DISTANCE FROM ELECTRICAL LINES AND APPARATUS.

MAINTAIN SAFE CLEARANCE FROM ELECTRICAL LINES AND APPARATUS. ALLOW FOR PLATFORM SWAY, ROCK OR SAG AND ELECTRICAL LINE SWAYING. THE MACHINE DOES NOT PROVIDE PROTECTION FROM CONTACT WITH OR PROXIMITY TO AN ELECTRICALLY CHARGED CONDUCTOR.

MAINTAIN A CLEARANCE OF AT LEAST 10 FEET (3 M) BETWEEN ANY PART OF THE MACHINE OR ITS LOAD AND ANY ELECTRICAL LINE OR APPARATUS CARRYING UP TO 50,000 VOLTS. ONE FOOT (0.3 M) ADDITIONAL CLEARANCE IS REQUIRED FOR EVERY ADDITIONAL 30,000 VOLTS OR LESS.

1-4. PRE-OPERATIONAL.

READ YOUR MANUAL. UNDERSTAND WHAT YOU'VE READ - THEN BEGIN OPERATIONS.

ALLOW ONLY THOSE AUTHORIZED AND QUALIFIED PERSONNEL TO OPERATE MACHINE WHO HAVE DEMONSTRATED THAT THEY UNDERSTAND SAFE AND PROPER OPERATION AND MAINTENANCE OF THE UNIT.

AN OPERATOR MUST NOT ACCEPT OPERATING RESPONSIBILITIES UNTIL ADEQUATE TRAINING HAS BEEN GIVEN BY COMPETENT AND AUTHORIZED PERSONS.

BEFORE OPERATION CHECK WORK AREA FOR BARE OVERHEAD ELECTRIC LINES, MACHINE TRAFFIC SUCH AS BRIDGE CRANES, HIGHWAY, RAILWAY AND CONSTRUCTION EQUIPMENT.

PRECAUTIONS TO AVOID ALL KNOWN HAZARDS IN THE WORK AREA MUST BE TAKEN BY THE OPERATOR AND HIS SUPERVISOR BEFORE STARTING THE WORK.

DO NOT OPERATE THIS MACHINE UNLESS IT HAS BEEN SERVICED AND MAINTAINED ACCORDING TO THE MANUFACTURERS SPECIFICATIONS AND SCHEDULE.

ENSURE DAILY INSPECTION AND FUNCTION CHECK IS PERFORMED PRIOR TO PLACING MACHINE INTO OPERATION.

NEVER DISABLE OR MODIFY ANY SAFETY DEVICE. ANY MODIFICATION OF THE MACHINE IS A SAFETY VIOLATION AND IS A VIOLATION OF OSHA RULES.

DO NOT OPERATE MACHINE WHEN WIND CONDITIONS EXCEED 20 MPH.

NEVER OPERATE OR RAISE PLATFORM WHEN MACHINE IS ON A TRUCK OR OTHER VEHICLE.

APPROVED HEAD GEAR MUST BE WORN WHEN REQUIRED BY ALL OPERATING AND GROUND PERSONNEL.

READ AND OBEY ALL WARNINGS, CAUTIONS AND OPERATING INSTRUCTIONS ON MACHINE AND IN THIS MANUAL.

BE FAMILIAR WITH LOCATION AND OPERATION OF GROUND STATION CONTROLS.

1-5. DRIVING.

WATCH FOR OBSTRUCTIONS AROUND MACHINE AND OVERHEAD WHEN DRIVING.

CHECK TRAVEL PATH FOR PERSONS, HOLES, BUMPS, DROP-OFFS, OBSTRUCTIONS, DEBRIS, AND COVERINGS WHICH MAY CONCEAL HOLES AND OTHER HAZARDS.

WHEN DRIVING IN HIGH SPEED, SWITCH TO LOW BEFORE STOPPING. TRAVEL GRADES IN LOW DRIVE ONLY.

DO NOT DRIVE ON GRADES AND SIDESLOPES EXCEEDING THOSE INDICATED ON CAUTION PLACARD AT MACHINE PLATFORM.

BEFORE DRIVING ON FLOORS, BRIDGES, TRUCKS AND OTHER SURFACES, CHECK ALLOWABLE CAPACITY OF SURFACES.

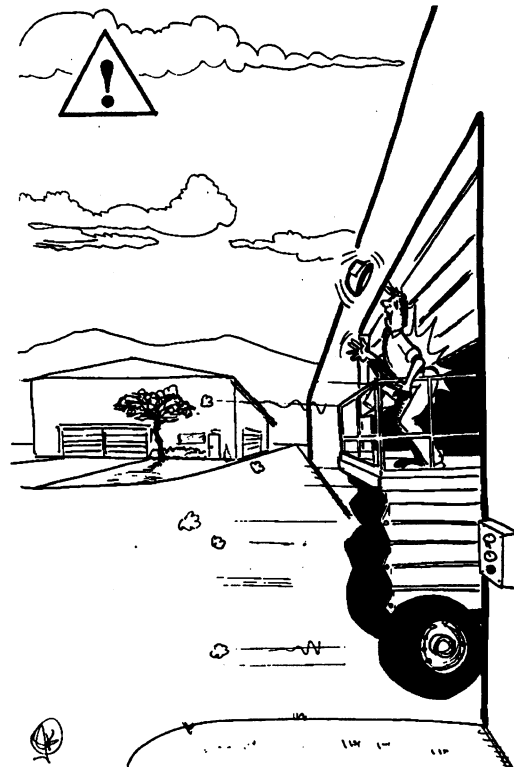

ALWAYS LOOK IN THE DIRECTION OF TRAVEL.

DO NOT TRAVEL ON SOFT OR UNEVEN SURFACES, AS TIPPING WILL OCCUR.

DO NOT USE HIGH SPEED DRIVE IN RESTRICTED OR CLOSE QUARTERS OR WHEN DRIVING IN REVERSE.

BE AWARE OF STOPPING DISTANCES WHEN TRAVELING IN HIGH AND LOW SPEEDS.

ALWAYS POST A LOOKOUT AND SOUND HORN WHEN DRIVING IN AREAS WHERE VISION IS OBSTRUCTED.

KEEP NON-OPERATING PERSONNEL AT LEAST 6 FEET (1.8 M) AWAY FROM MACHINE DURING DRIVING OPERATIONS.

1-6. OPERATION.

READ YOUR MANUAL, UNDERSTAND WHAT YOU'VE READ - THEN BEGIN OPERATIONS.

DO NOT OPERATE ANY MACHINE ON WHICH DANGER, WARNING, CAUTION OR INSTRUCTION PLACARDS OR DECALS ARE MISSING OR ILLEGIBLE.

MACHINE MUST ALWAYS BE SHUT DOWN WHEN REFUELING. 'NO SMOKING' IS MANDATORY. NEVER REFUEL DURING AN ELECTRICAL STORM. ENSURE THAT FUEL CAP IS CLOSED AND SECURE AT ALL OTHER TIMES.

NEVER EXCEED MANUFACTURERS RATED PLATFORM CAPACITY - REFER TO CAPACITY DECAL ON MACHINE. DISTRIBUTE LOAD EVENLY ON PLATFORM FLOOR.

ENSURE MACHINE IS POSITIONED ON A FIRM, LEVEL AND UNIFORM SURFACE BEFORE RAISING PLATFORM.

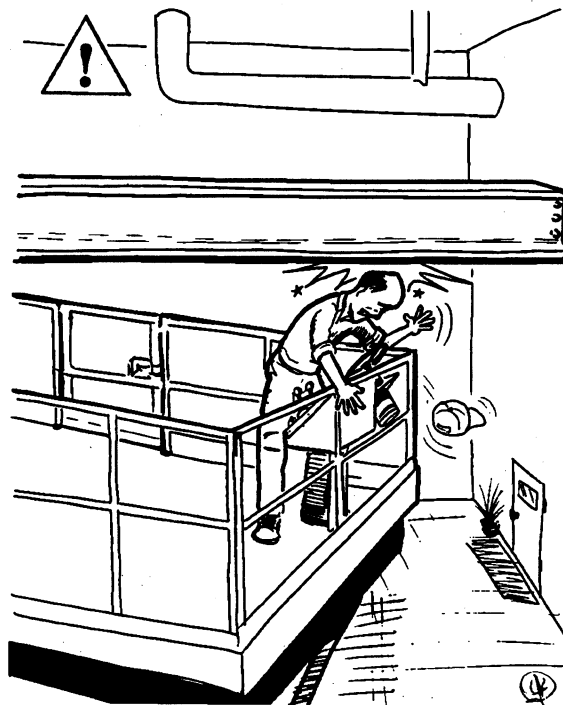

THOROUGHLY CHECK ALL CLEARANCES BEFORE POSITIONING PLATFORM.

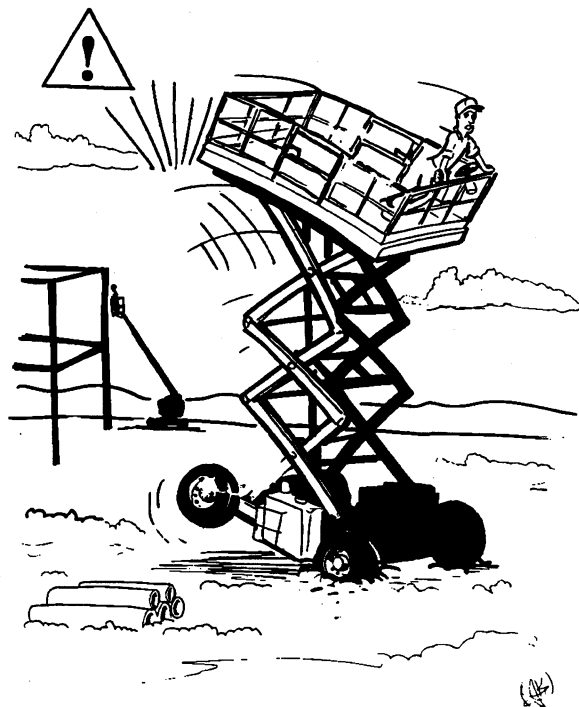

NEVER OPERATE ON SOFT OR UNEVEN SURFACES.

NEVER 'SLAM' A CONTROL SWITCH OR LEVER THROUGH NEUTRAL TO OPPOSITE DIRECTION. ALWAYS RETURN SWITCH TO NEUTRAL AND STOP; THEN MOVE SWITCH TO THE DESIRED POSITION. OPERATE LEVERS WITH SLOW, EVEN PRESSURE.

NEVER OPERATE A MALFUNCTIONING MACHINE. IF A MALFUNCTION OCCURS, SHUT DOWN THE MACHINE, RED TAG IT, AND NOTIFY PROPER AUTHORITIES.

CHECK CLEARANCES ABOVE, ON SIDES AND BOTTOM OF PLATFORM WHEN RAISING AND LOWERING PLATFORM.

NEVER USE SIZZOR ARMS TO GAIN ACCESS TO OR LEAVE PLATFORM.

DO NOT ATTACH OVERHANGING LOADS TO THE PLATFORM OR INCREASE THE PLATFORM SIZE WITH UNAUTHORIZED DECK EXTENSIONS OR ATTACHMENTS.

DO NOT ELEVATE PLATFORM WHILE DRIVING, OR UNLESS MACHINE IS LEVEL.

DO NOT TIE OFF MACHINE TO ANY ADJACENT STRUCTURE. NEVER ATTACH WIRE, CABLE OR ANY SIMILAR ITEMS TO PLATFORM.

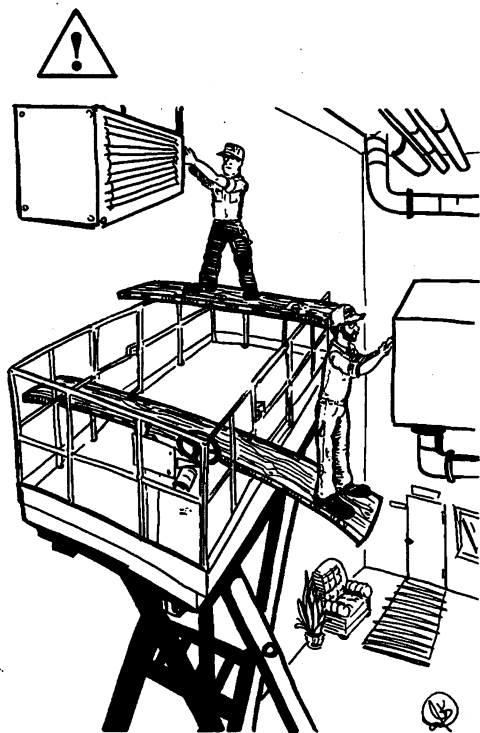

ALWAYS STAND ON PLATFORM FLOOR, NOT ON BOXES, PLANKS OR RAILINGS.

DURING ENTRY OR EXIT ABOVE GROUND OSHA REQUIRES THAT SAFETY BELT BE ATTACHED TO THE STRUCTURE BEING ENTERED.

TO AVOID FALLING - USE EXTREME CAUTION WHEN ENTERING OR LEAVING PLATFORM ABOVE GROUND. ENTER OR EXIT THRU GATE ONLY. PLATFORM MUST BE WITHIN 1 FOOT (0.3 M) OF ADJACENT - SAFE AND SECURE - STRUCTURE.

NO STUNT DRIVING OR HORSEPLAY IS PERMITTED.

DO NOT ALLOW PERSONNEL TO TAMPER WITH, SERVICE, OR OPERATE THIS MACHINE FROM THE GROUND WITH PERSONNEL IN PLATFORM EXCEPT IN AN EMERGENCY.

WHEN TWO OR MORE PERSONS ARE IN PLATFORM, THE OPERATOR SHALL BE RESPONSIBLE FOR ALL MACHINE OPERATIONS.

DURING OPERATION KEEP ALL BODY PARTS INSIDE PLATFORM RAILINGS.

NEVER POSITION LADDERS, STEPS, OR SIMILAR ITEMS ON UNIT TO PROVIDE ADDITIONAL REACH FOR ANY PURPOSE.

WHEN RIDING IN OR WORKING FROM PLATFORM BOTH FEET MUST BE FIRMLY POSITIONED ON DECK.

DO NOT EXTEND REACH LIMITS OF THIS MACHINE WITH ADDITIONAL EQUIPMENT SUCH AS PLANKS, BOXES, ETC.

OBSERVE EXTREME CAUTION AT ALL TIMES TO PREVENT OBSTACLES FROM STRIKING OR INTERFERING WITH OPERATING CONTROLS AND PERSONS IN THE PLATFORM.

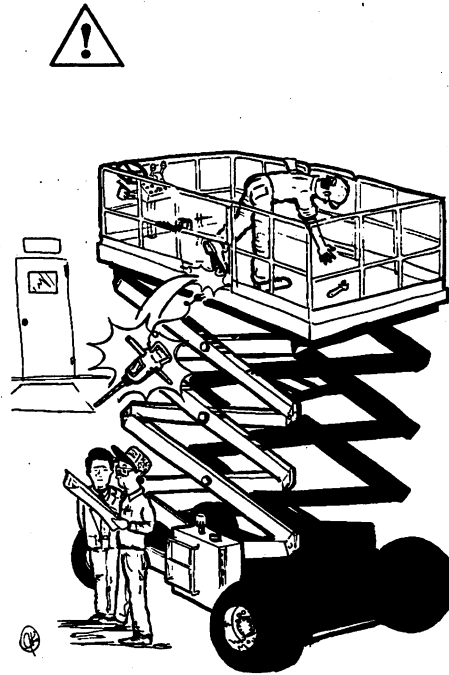

KEEP EVERYONE CLEAR OF A WORKING PLATFORM.

ENSURE THAT OPERATORS OF OTHER OVERHEAD AND FLOOR LEVEL MACHINES ARE AWARE OF THE AERIAL PLATFORMS PRESENCE. DISCONNECT POWER TO OVERHEAD CRANES. BARRICADE FLOOR AREA IF NECESSARY.

DO NOT OPERATE WITHOUT HANDRAILS IN PLACE AND SECURED. IT IS A SAFETY VIOLATION.

DO NOT STEP OUTSIDE OF HANDRAILS.

ALWAYS ENSURE THAT POWER TOOLS ARE PROPERLY STOWED AND NEVER LEFT HANGING BY THEIR CORD FROM THE PLATFORM WORK AREA.

AVOID ACCUMULATION OF DEBRIS ON PLATFORM WORK AREA. KEEP MUD, OIL, GREASE AND OTHER SLIPPERY SUBSTANCES FROM FOOTWEAR AND PLATFORM DECK.

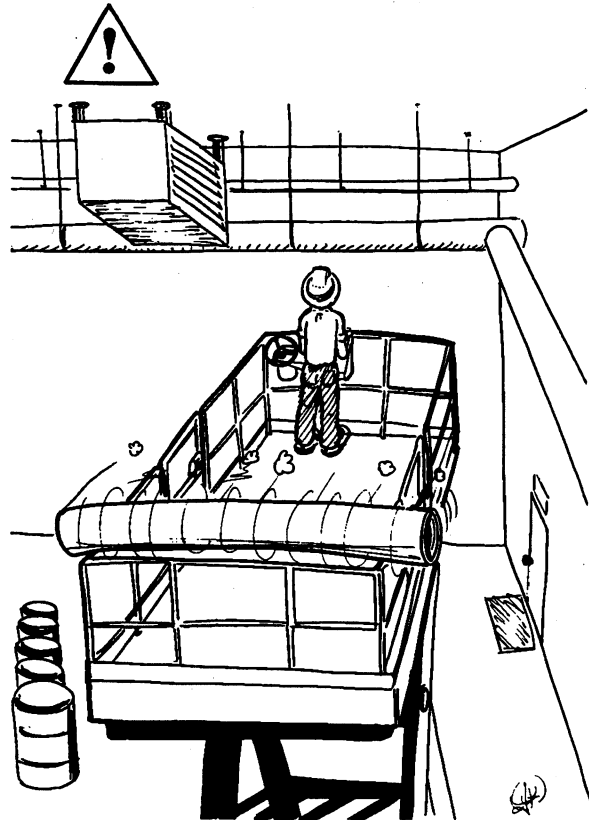

PLATFORM RAILS ARE NOT FOR HANDLING MATERIAL.

1-7. TOWING AND HAULING.

NEVER ATTEMPT TO TOW OR PULL MACHINE. ALWAYS CARRY MACHINE WITH FORKLIFT OF SUITABLE CAPACITY.

HAVE PLATFORM COMPLETELY EMPTY OF TOOLS AND DEBRIS BEFORE CARRYING.

WHEN LIFTING MACHINE, POSITION FORKS ONLY AT DESIGNATED AREA AT REAR OF MACHINE.

HAVE PLATFORM FULLY RETRACTED WHILE MACHINE IS BEING CARRIED.

NEVER ALLOW PERSONNEL IN PLATFORM WHILE CARRYING.

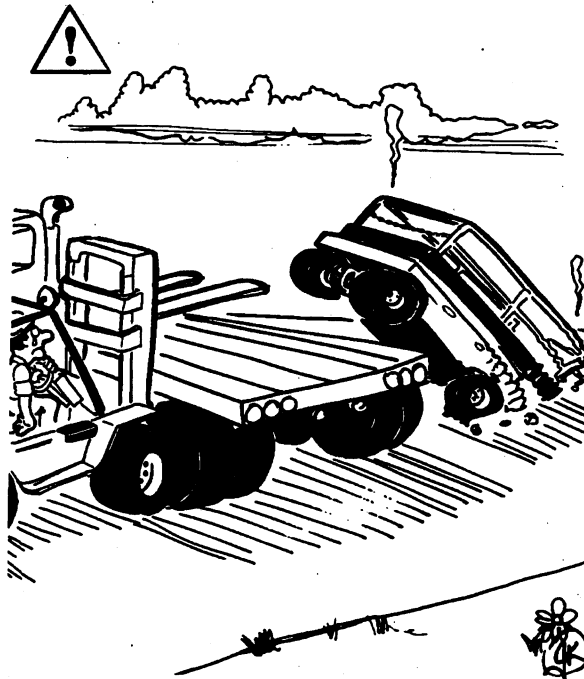

LIFT MACHINE AT DESIGNATED AREA ONLY..

1-8. MAINTENANCE.

- a. This section contains the general safety precautions which must be observed during maintenance of the aerial platform. It is of utmost importance that maintenance personnel pay strict attention to these warnings and precautions to avoid possible injury to themselves or others or damage to the equipment. A maintenance program must be established by a qualified person and must be followed to ensure that the machine is safe to operate.

WARNING

MODIFICATION OF THE MACHINE WITHOUT CERTIFICATION BY A RESPONSIBLE AUTHORITY THAT THE MACHINE IS AT LEAST AS SAFE AS ORIGINALLY MANUFACTURED IS A SAFETY VIOLATION.

- b. The specific precautions to be observed during machine maintenance are inserted at the appropriate point in the manual. These precautions are, for the most part, those that apply when servicing hydraulic and larger machine component parts.
- c. Your safety, and that of others, is the first consideration when engaging in the maintenance of equipment. Always be conscious of weight.

Never attempt to move heavy parts without the aid of a mechanical device. Do not allow heavy objects to rest in an unstable position. When raising a portion of the equipment, ensure that adequate support is provided.

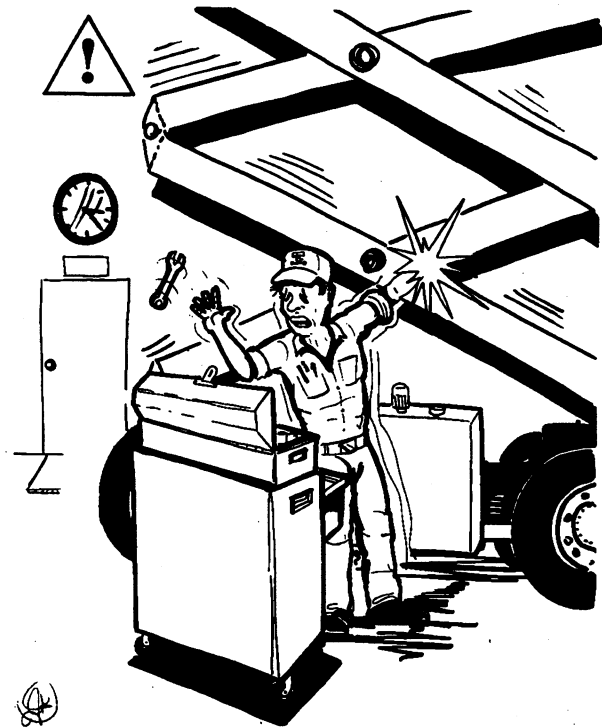

USE SAFETY PROPS WHEN PERFORMING MAINTENANCE.

ALWAYS DISCONNECT BATTERIES WHEN REPLACING ELECTRICAL COMPONENTS.

REMOVE RINGS, WATCHES AND JEWELRY WHEN PERFORMING ANY MAINTENANCE.

DO NOT WEAR LOOSE FITTING CLOTHING OR LONG HAIR UNRESTRAINED, WHICH IS APT TO BECOME CAUGHT ON, OR ENTANGLED IN EQUIPMENT.

USE ONLY CLEAN APPROVED NONFLAMMABLE CLEANING SOLVENTS.

SHUT OFF ALL POWER CONTROLS BEFORE MAKING ADJUSTMENTS, LUBRICATING OR PERFORMING ANY OTHER MAINTENANCE.

NEVER WORK UNDER AN ELEVATED PLATFORM UNTIL IT HAS BEEN RESTRAINED FROM MOVEMENT WITH SAFETY PROPS, BLOCKING OR OVERHEAD SLING.

NEVER ALTER, REMOVE OR SUBSTITUTE ANY ITEM SUCH AS COUNTERWEIGHTS, FOAM FILLED TIRES, BATTERIES, ETC. WHICH WOULD REDUCE THE OVERALL WEIGHT OR BASE STABILITY OF THE MACHINE.

2-1. GENERAL.

This section provides the necessary information needed by those personnel that are responsible to place the machine in operation readiness, and lists checks that are performed prior to use of the machine. It is important that the information contained in this section be read and understood before any attempt is made to operate the machine. Ensure that all the necessary inspections have been completed successfully before placing the machine into service. These procedures will aid in obtaining maximum service life and safe operation.

IMPORTANT

SINCE THE MACHINE MANUFACTURER HAS NO DIRECT CONTROL OVER THE FIELD INSPECTION AND MAINTENANCE, SAFETY IS THE RESPONSIBILITY OF THE OWNER/OPERATOR.

2-2. PREPARATION FOR USE.

- a. Before a new machine is put into operation it must be carefully inspected for any evidence of damage resulting from shipment and inspected periodically thereafter, as outlined in paragraph 2-3, Delivery and Periodic Inspection. The unit should be thoroughly checked for hydraulic leaks during initial start-up and run. A check of all components should be made to assure their security.
- b. All preparation necessary to place the machine in operation readiness status are the responsibility of management personnel. Preparation requires good common sense, (i.e. lift works smoothly and brakes operate properly) coupled with a series of visual inspections. The mandatory requirements are given in paragraph 2-4, Daily Walk Around Inspection.
- c. It should be assured that the items appearing in the Delivery and Periodic Inspection and Functional Check are complied with prior to putting the machine into service.

2-3. DELIVERY AND PERIODIC INSPECTION.**Note**

This machine requires periodic safety and maintenance inspections by a JLG Dealer. A decal located on the frame provides a place to record (stamp) inspection dates. Check decal and notify dealer if inspection is overdue.

- a. The following checklist provides a systematic inspection to assist in detecting defective, damaged, or improperly installed parts. The checklist denotes the items to be inspected and conditions to examine. Periodic inspection shall be performed monthly or more often when required by environment, severity, and frequency of usage.

(1). Handrail Assemblies.

Properly installed; no loose or missing parts; no visible damage.

(2). Platform Assembly.

No visible damage; free of dirt and debris.

(3). Sizzor Arms.

No visible damage, abrasions and/or distortions.

(4). Electrical Cable.

No visible damage; properly secured.

(5). Pivot Pins.

No loose or missing retaining hardware; no damage or wear to pin heads which would cause pin to rotate; no evidence of pin or bushing wear.

(6). Lift Cylinder.

No rust, nicks, scratches or foreign material on piston rod. No leakage. Evidence of proper lubrication.

(7). Frame.

No visible damage; loose or missing hardware (top and underside).

(8). Tire and Wheel Assemblies.

No loose or missing lug nuts; no visible damage.

(9). Sliding Wear Pad Blocks.

No excessive wear; adequate lubrication.

(10). Hydraulic Oil Supply.

Note

Prior to checking the hydraulic oil level, operate the machine through one complete cycle of the lift function (full up and down). Failure to do so will result in an incorrect oil level reading on the hydraulic tank.

Level should be at full mark on side of hydraulic tank (all systems shut down,

machine in stowed position) immediately after up-down cycle.

(11). Steer Cylinder.

No rust, nicks, scratches or foreign material on piston rod; no leakage.

(12). Steer Linkage.

No loose or missing parts; no visible damage.

(13). Front Spindle Assemblies.

No excessive wear; no damage.

(14). Control Boxes. (Console and Ground)

Switches operable; no visible damage; placards secure and legible. If equipped, controller operable; no visible damage.

(15). Batteries.

Proper electrolyte level; cable connections tight; no visible damage; no corrosion at battery cable connections.

(16). Hydraulic Pump and Valves.

No leakage; units secure.

(17). Platform Placards.

No visible damage; placards secure and legible.

2-4. DAILY WALK-AROUND INSPECTION.

- a. It is the user's responsibility to inspect the machine before the start of each workday. It is recommended that each user inspect the machine before operation, even if the machine has already been put into service under another user. This Daily Walk-Around Inspection is the preferred method of inspection. (See Figures 2-1 and 2-2.)
- b. In addition to the Daily Walk-Around Inspection, be sure to include the following as part of the daily inspection:
 - (1). Overall Cleanliness.

Check all standing surfaces for oil, fuel and hydraulic oil spillage and foreign objects. Ensure overall cleanliness.
 - (2). Placards.

Keep all information and operating placards clean and unobstructed. Cover

when spray painting or shot blasting to protect legibility.

(3). Operators, Service, and Parts Manual.

Ensure a copy of this manual is enclosed in the manual storage box.

(4). Machine Log.

Ensure a machine operating record or log is kept. Check to see that it is current and that no entries have been left uncleared, leaving machine in an unsafe condition for operation.

(5). Daily Lubrication.

For those items pointed out in the Daily Walk-Around Inspection requiring daily lubrication, refer to the Lubrication Charts, Figures 7-2 and 7-3, for specific requirements.

- c. Perform the following checks and services before attempting to operate the machine.

WARNING

TO AVOID INJURY DO NOT OPERATE A MACHINE UNTIL ALL MALFUNCTIONS HAVE BEEN CORRECTED. USE OF A MALFUNCTIONING MACHINE IS A SAFETY VIOLATION.

- (1). Start each day with fully charged batteries.
- (2). Ensure that all items requiring lubrication are serviced in accordance with the Lubrication Charts, Figures 7-2 and 7-3.
- (3). Perform functional checks in accordance with paragraph 2-5, Daily Functional Check.

2-5. DAILY FUNCTIONAL CHECK.

WARNING

TO AVOID INJURY DO NOT OPERATE A MACHINE UNTIL ALL MALFUNCTIONS HAVE BEEN CORRECTED. USE OF A MALFUNCTIONING MACHINE IS A SAFETY VIOLATION.

- a. A functional check of all systems should be performed, under no load, once the walk-around inspection is complete, in an area free of overhead and ground level obstructions. Perform pre-load functional check in accordance with the following procedure:
 - (1). Raise and lower platform several times. Check for smooth elevation and lowering.

Check for High Drive cut-out as platform begins to raise.

- (2). Drive forward and reverse, check for proper operation.
- (3). Check that drive brake holds when machine is driven up a hill, not to exceed rated gradeability, and stopped.
- (4). Steer left and right. Check for proper operation.
- (5). Check hydraulic oil reservoir dipstick. Refer to Lubrication Chart.

2-6. TORQUE REQUIREMENTS.

The Torque Chart, Figure 7-1, consists of standard torque values based on bolt diameter and grade, also specifying dry and wet torque values in accordance with recommended shop practices. This chart is provided as an aid to the operator in the event he/she notices a condition that requires prompt attention during the walk-around inspection or during operation until the proper service personnel can be notified. Section 7 provides specific torque values and periodic maintenance procedures with a listing of individual components. Utilizing this Torque Chart in conjunction with the preventive maintenance section in Section 8, will enhance safety, reliability and performance of the machine.

2-7. BATTERY CHARGING.

At the end of the work day, the batteries should be charged for the next days work. Position the Emergency Stop switch to OFF. Prior to charging, be sure electrolyte covers plates. Connect the battery charger to a properly grounded receptacle using a suitable extension cord. Set the battery charger timer switch, if equipped, for the desired charging time. After charging, check the electrolyte level of the batteries and adjust accordingly. Add distilled water only to batteries. A fully charged battery will have a specific gravity of between 1.260 - 1.275 on a hydrometer.

CAUTION

WHEN ADDING DISTILLED WATER TO THE BATTERIES, A NON-METALLIC CONTAINER AND/OR FUNNEL MUST BE USED.

NO OPEN FLAMES OR SMOKING WHEN CHARGING BATTERIES.

CHARGE BATTERIES ONLY IN A WELL VENTILATED AREA.

ENSURE THAT BATTERY ACID DOES NOT COME INTO CONTACT WITH SKIN OR CLOTHING.

Notes

Be sure to disconnect and store any extension cords after charging batteries and before putting machine into service.

To avoid electrolyte overflow, add distilled water to batteries after charging.

Refer to JLG Publication 3120367 for applicable battery charger information.

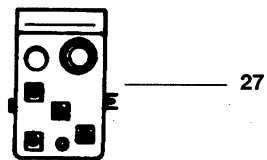
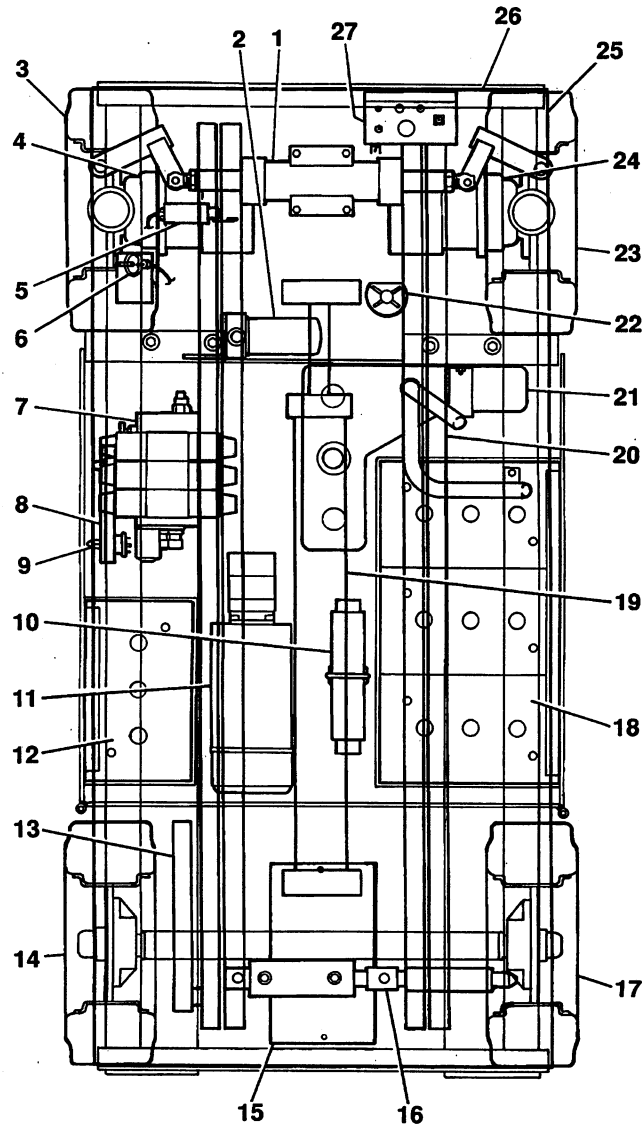

Insert A. Platform Control Box.
Machines Built After October 1992.

Figure 2-1. Daily Walk-Around Inspection - CM1432. (Sheet 1 of 2)

GENERAL.

Begin the "Walk-Around Inspection" at Item 1, as noted on the diagram. Continue to the right (counterclockwise viewed from top) checking each item in sequence for the conditions listed in the "Walk-Around Inspection Checklist".

WARNING

TO AVOID INJURY DO NOT OPERATE MACHINE UNTIL ALL MALFUNCTIONS HAVE BEEN CORRECTED. USE OF A MALFUNCTIONING MACHINE IS A SAFETY VIOLATION.

TO AVOID POSSIBLE INJURY, BE SURE MACHINE POWER IS "OFF" DURING "WALK-AROUND INSPECTION".

Note

Do not overlook visual inspection of chassis underside. Checking this area often results in discovery of conditions which could cause extensive machine damage.

1. Steer Cylinder and Linkage - No loose or missing parts, no visible damage. No steer cylinder leaks or damage.
 2. Hydraulic Filter - No visible damage, properly secured, no evidence of leakage.
 3. Steer/Drive Wheel and Tire Assembly, Left Front - Properly secured, no loose or missing lug nuts, no visible damage.
 4. Drive Motor, Left Front - No visible damage, no evidence of leakage.
 5. High Drive Limit Switch - Properly secured, no visible damage.
 6. Manual Descent Cable and Pull Ring - Properly secured, no loose or missing parts, no visible damage.
 7. Control Valve Installation - No loose or missing parts, no evidence of leakage. No unsupported wires or hoses, no damaged or broken wires.
 8. Ground Controls - Switches operable, no visible damage, placards secure and legible.
 9. Battery Switch - Properly secured, no visible damage, placard in place and legible.
 10. Cushion Cylinder (Accumulator) - Properly secured, no visible damage, no evidence of leakage.
 11. Motor/Pump Unit - Properly secured, no visible damage, no evidence of hydraulic leaks.
 12. Battery Installation - Proper electrolyte level, cables secure, no damage or corrosion. Holddowns secure.
 13. Safety Prop - Stored securely, no visible damage or missing parts.
 14. Wheel and Tire Assembly, Left Rear - Properly secured, no loose or missing lug nuts, no visible damage.
 15. Battery Charger - No damage, properly secured.
 16. Parking Brake - Brake cylinder secure, no loose or missing parts, no visible damage or cylinder leaks.
 17. Wheel and Tire Assembly, Right Rear - Properly secured, no loose or missing lug nuts, no visible damage.
 18. Battery Installation - Proper electrolyte level, cables secure, no damage or corrosion. Holddowns secure.
 19. Lift Cylinder - Properly secured, no visible damage, no loose or missing parts, no evidence of leakage.
 20. Sizzor Arms and Sliding Wear Pads - Properly secured, no visible damage, evidence of proper lubrication. Inspect sizzor arm guards for damage and proper installation.
 21. Hydraulic Reservoir - No visible damage or missing parts, no evidence of leaks. Recommended hydraulic fluid level on dipstick (Cold fluid, system shut down, machine in stowed position.). Breather cap secure and working.
 22. Tilt Alarm (If Equipped) - Properly secured, no loose or missing parts, no visible damage.
 23. Steer/Drive Wheel and Tire Assembly, Right Front - Properly secured, no loose or missing lug nuts, no visible damage.
 24. Drive Motor, Right Front - No visible damage, no evidence of leakage.
 25. Handrail Installation - All railings securely attached, no visible damage, no missing parts, chain in proper working order.
 26. Platform Assembly - No loose or missing parts, no visible damage, platform deck extension operates properly.
 27. Platform Controls - Properly secured, no loose or missing parts, no visible damage. Placards secure and legible, control switches return to neutral. Control markings legible, manual in manual storage box.
- NOTE: Platform Control Box on machines built prior to October 1992 shown; see Insert A for Platform Control Box on machines built after October 1992.

Figure 2-1. Daily Walk-Around Inspection - CM1432. (Sheet 2 of 2)

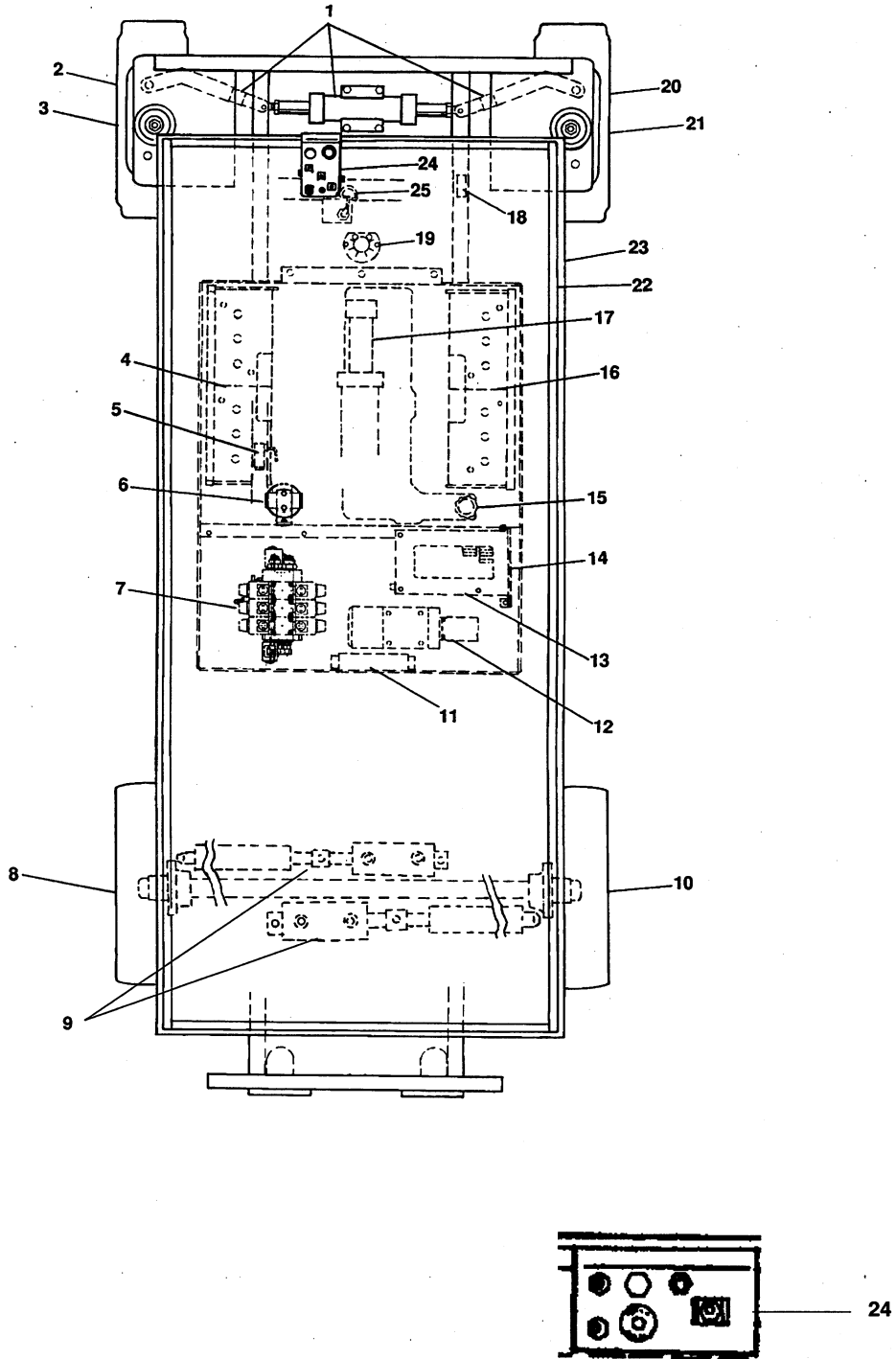

Insert A. Platform Control Box -
Machines Built Before August 1992.

Figure 2-2. Daily Walk-Around Inspection - CM2033/CM2046/CM2546/CM2558. (Sheet 1 of 2)

GENERAL.

Begin the "Walk-Around Inspection" at Item 1, as noted on the diagram. Continue to the right (counterclockwise viewed from top) checking each item in sequence for the conditions listed in the "Walk-Around Inspection Checklist".

WARNING

TO AVOID INJURY DO NOT OPERATE MACHINE UNTIL ALL MALFUNCTIONS HAVE BEEN CORRECTED. USE OF A MALFUNCTIONING MACHINE IS A SAFETY VIOLATION.

TO AVOID POSSIBLE INJURY, BE SURE MACHINE POWER IS "OFF" DURING "WALK-AROUND INSPECTION".

Note

Do not overlook visual inspection of chassis underside. Checking this area often results in discovery of conditions which could cause extensive machine damage.

1. Steer Cylinder and Linkage - No loose or missing parts, no visible damage. No steer cylinder leaks or damage.
2. Steer/Drive Wheel and Tire Assembly, Left Front - Properly secured, no loose or missing lug nuts, no visible damage.
3. Drive Motor, Left Front - No visible damage, no evidence of leakage.
4. Battery Installation - Proper electrolyte level, cables secure, no damage or corrosion. Holddowns secure.
5. Limit Switch - Properly secured, no visible damage.
6. Hydraulic Filter - No visible damage, properly secured, no evidence of leakage.
7. Control Valve Installation - No loose or missing parts, no evidence of leakage. No unsupported wires or hoses, no damaged or broken wires.
8. Wheel and Tire Assembly, Left Rear - Properly secured, no loose or missing lug nuts, no visible damage.
9. Parking Brake - No loose or missing parts, no visible damage. No cylinder leaks.
10. Wheel and Tire Assembly, Right Rear - Properly secured, no loose or missing lug nuts, no visible damage.
11. Cushion Cylinder - Properly secured, no visible damage, no evidence of leakage.
12. Motor/Pump Unit - Properly secured, no visible damage, no evidence of hydraulic leaks.
13. Battery Charger - No damage, properly secured.
14. Ground Controls - Switches operable, no visible damage, placards secure and legible.
15. Hydraulic Reservoir - No visible damage or missing parts, no evidence of leaks. Recommended hydraulic fluid level on dipstick. (Cold fluid, system shut down, machine in stowed position.) Breather cap secure and working.
16. Battery Installation - Proper electrolyte level, cables secure, no damage or corrosion. Holddowns secure.
17. Lift Cylinder - Properly secured, no visible damage, no loose or missing parts, no evidence of leakage.
18. Sizzor Arms and Sliding Wear Pads - Properly secured, no visible damage, evidence of proper lubrication. Inspect sizzor arm guards for damage and proper installation.
19. Tilt Alarm - Properly secured, no loose or missing parts, no visible damage.
20. Steer/Drive Wheel and Tire Assembly, Right Front - Properly secured, no loose or missing lug nuts, no visible damage.
21. Drive Motor, Right Front - No visible damage, no evidence of leakage.
22. Handrail Installation - All railings securely attached, no visible damage, no missing parts, chain in proper working order.
23. Platform Assembly - No loose or missing parts, no visible damage, platform deck extension operates properly.
24. Platform Controls - Properly secured, no loose or missing parts, no visible damage. Placards secure and legible, control switches return to neutral. Control markings legible, manual in manual storage box.
NOTE: Platform Control Box on machines built after October 1992 shown; see Insert A for Platform Control Box on machines built before October 1992.
25. Manual Descent Cable and Pull Ring - Properly secured, no loose or missing parts, no visible damage.
NOTE: Manual Descent Handle is shown in location used on machines built until December 1991. Machines built after December 1991 have the Manual Descent Cable located on the left front side of the frame.
26. Valves, Valve Fittings, Hosing and Tubing - properly secured, no loose or missing parts, no visible damage, no evidence of leakage.

Figure 2-2. Daily Walk Around Inspection - CM2033/CM2046/CM2546/CM2558. (Sheet 2 of 2)

3-1. GENERAL.

IMPORTANT

SINCE THE MANUFACTURER HAS NO DIRECT CONTROL OVER MACHINE APPLICATION AND OPERATION, CONFORMANCE WITH GOOD SAFETY PRACTICES IN THESE AREAS IS THE RESPONSIBILITY OF THE USER AND HIS OPERATING PERSONNEL.

This section provides the necessary information needed to understand control functions. Included in this section are the operating characteristics and limitations, and functions and purposes of controls and indicators. It is important that the user read and understand the proper procedures before operating the machine. These procedures will aid in obtaining optimum service life and safe operation.

3-2. PERSONNEL TRAINING.

- a. The sizzor lift is a personnel handling device; therefore, it is essential that it be operated and maintained only by authorized personnel who have demonstrated that they understand the proper use and maintenance of the machine. It is important that all personnel who are assigned to and responsible for the operation and maintenance of the machine undergo a thorough training program and check out period in order to become familiar with the characteristics prior to operating the machine.

Persons under the influence of drugs or alcohol or who are subject to seizures, dizziness or loss of physical control must not be permitted to operate the machine.

b. Operator Training.

Operator training must include instruction in the following:

- (1). Use and limitations of the platform controls, ground controls, emergency controls and safety systems.
- (2). Knowledge and understanding of this manual and of the control markings, instructions and warnings on the machine itself.
- (3). Knowledge and understanding of all safety work rules of the employer and of Federal, State and Local Statutes, including training in the recognition and avoidance of potential hazards in the work place; with particular attention to the work to be performed.

- (4). Proper use of all required personnel safety equipment.
- (5). Sufficient knowledge of the mechanical operation of the machine to recognize a malfunction or potential malfunction.
- (6). The safest means to operate near overhead obstructions, other moving equipment, obstacles, depressions, holes, dropoffs, etc. on the supporting surface.
- (7). Means to avoid the hazards of unprotected electrical conductors.
- (8). Any other requirements of a specific job or machine application.

c. Training Supervision.

Training must be done under the supervision of a qualified operator or supervisor in an open area free of obstructions until the trainee has developed the ability to safely control a sizzor lift in congested work locations.

d. Operator Responsibility.

The operator must be instructed that he has the responsibility and authority to shut down the machine in case of a malfunction or other unsafe condition of either the machine or the job site and to request further information from his supervisor or JLG Distributor before proceeding.

Note

Manufacturer or Distributor will provide qualified persons for training assistance with first unit(s) delivered and thereafter as requested by user or his personnel.

3-3. OPERATING CHARACTERISTICS AND LIMITATIONS.

a. General.

A thorough knowledge of the operating characteristics and limitations of the machine is always the first requirement for any user, regardless of user's experience with similar types of equipment.

b. Placards.

Important points to remember during operation are provided at the control stations by DANGER, WARNING, CAUTION, IMPORTANT and INSTRUCTION placards. This information is placed at various locations for the express purpose of alerting personnel of potential hazards constituted by the operating characteristics and load limitations of the machine. See foreword for definitions of the above placards.

c. Capacities.

Raising platform above horizontal with or without any load in platform, is based on the following criteria:

- (1). Machine is positioned on a smooth, firm and level surface.
- (2). Load is within manufacturer's rated capacity.
- (3). All machine systems are functioning properly.

d. Stability.

This machine, as originally manufactured by JLG and operated within its rated capacity on a smooth, firm and level supporting surface, provides a stable aerial platform for all platform positions.

3-4. CONTROLS AND INDICATORS.

Some machines may be equipped with control panels that use symbols instead of words to indicate control functions. Refer to Table 3-1 for these symbols and their corresponding functions.

a. Ground Control Station. (Figure 3-1.)**WARNINGS**

DO NOT OPERATE FROM GROUND CONTROL STATION WITH PERSONNEL IN THE PLATFORM EXCEPT IN AN EMERGENCY.

PERFORM AS MANY PRE-OPERATIONAL CHECKS AND INSPECTIONS FROM THE GROUND CONTROL STATION AS POSSIBLE.

Note

When the machine is shut down for overnight parking or battery charging, the EMERGENCY STOP switch must be positioned to OFF to prevent draining the batteries.

(1). EMERGENCY STOP Switch.

A two-position, lever operated EMERGENCY STOP switch, when positioned to ON, furnishes operating power to the PLATFORM/GROUND SELECT switch.

(2). POWER SELECTOR Switch.

A three position, key-operated POWER SELECTOR switch supplies operating power to the platform or ground controls, as selected. When positioned to PLATFORM, the switch provides power to the platform controls. When positioned to

GROUND, the switch provides power to the ground controls. With the POWER SELECTOR switch in the center off position, power is shut off to both platform and ground controls.

Notes

With the POWER SELECTOR switch in the OFF position, the key can be removed in order to incapacitate the machine on the jobsite to avoid unauthorized use of the machine.

With the POWER SELECTOR switch positioned to GROUND, engine speed will stay in LOW at all times.

(3). Lift Switch.

A three position, momentary contact LIFT control switch provides raising and lowering of the platform when positioned to UP or DOWN.

(4). Circuit Breaker.

A push button reset 15 Amp circuit breaker, located at the ground control panel, returns interrupted power to the machine functions when depressed.

b. Platform Control Station.

(Figures 3-2, 3-3, 3-4, and 3-5.)

(1). Enable Switch.

Some machines built before August 1992 and all machines built after August 1992 are equipped with an ENABLE switch on the side of the platform control box. The ENABLE switch must be pressed before activating the DRIVE, LIFT or STEER functions. A built-in timer shuts off power to these functions if they are not activated within 3 seconds after the ENABLE switch is depressed. In addition, this timer will shut off power to the DRIVE and LIFT functions 3 seconds after they are deactivated, making it necessary to depress the ENABLE switch before activating DRIVE or LIFT again. The STEER function, unless activated in conjunction with the DRIVE or LIFT functions, will automatically cut off after 3 seconds of operation.

(2). Emergency Stop Switch.

An EMERGENCY STOP switch is provided in order to turn machine power on and off in the platform and also to turn off machine power in the event of an emergency. Power is turned on by pulling the switch up (ON), and is turned off by pushing the switch down (OFF).

- (3). Tilt Alarm Warning Horn.

The Tilt Alarm Warning Horn is activated by the Tilt Alarm Switch when the chassis is on a severe slope (over 5 degrees) with the platform elevated above the stowed position. In addition, DRIVE and LIFT UP functions are cut out until platform is lowered completely.

CAUTION

IF TILT ALARM IS ON WHEN PLATFORM IS RAISED, LOWER PLATFORM COMPLETELY, THEN REPOSITION MACHINE SO THAT IT IS LEVEL BEFORE RAISING PLATFORM.

- (4). Tilt Alarm Warning Light. (Red)

A warning light on the control console that lights when the chassis is on a severe slope (over 5 degrees). The light is illuminated whether the platform is raised or lowered, and will stay illuminated until machine is moved from slope.

Note

The LIFT, DRIVE, and STEER toggle switches automatically return to the center OFF position when released.

WARNING

TO AVOID SERIOUS INJURY, DO NOT OPERATE MACHINE IF LIFT, DRIVE, OR STEER TOGGLE SWITCHES DO NOT RETURN TO THE CENTER OFF POSITION WHEN RELEASED.

- (5). Lift Switch.

The LIFT toggle switch provides for raising and lowering the platform when positioned to UP or DOWN.

CAUTION

DO NOT "LIFT DOWN" WITHOUT COMPLETELY RETRACTING PLATFORM EXTENSION.

- (6). Positive Traction Switch.

This push button switch, when depressed, activates a solenoid on the main control valve, forcing oil through a flow divider in the drive circuit, maintaining hydraulic oil flow to both drive motors for improved traction.

- (7). Steer Switch. (w/o PQ Controller)

The Steer Switch is a three position, center off toggle switch that enables steering the machine to the right or left.

- (8). Drive Control Switch. (w/o PQ Controller)

The Drive Control Switch is a three position, center off toggle switch that enables the machine to travel in FORWARD or REVERSE.

Note

When machine is equipped with non-marking tires, DRIVE function is cut-out when platform is raised above 17 feet (5.2 meters) on Models CM2033 and CM2046, or when platform is raised above 21 feet (6.4 meters) on Models CM2546 and CM2558. Model CM1432 is not equipped with a DRIVE cut-out.

- (9). Drive Speed Switch.

A two position Drive Speed Switch allows additional oil flow to the drive circuit when positioned to HIGH. Machines built after January 1993 will incorporate a three position switch to give the operator an additional drive speed.

Note

The Drive Speed Switch will cut-out when platform is raised above stowed position, leaving only low speed available until platform is lowered completely.

CAUTION

DO NOT OPERATE MACHINE IF HIGH DRIVE SPEED OPERATES WHEN PLATFORM IS RAISED ABOVE THE STOWED POSITION.

- (10). PQ Controller. (If Equipped.)

The PQ Controller performs three functions: Drive, Steer and Drive Speed. Tilting the controller in the direction you want to go (forward or reverse) activates drive in that direction. The thumb-operated steer switch on top of the controller handle activates the steer wheels in the direction it is moved. Drive speed is determined by distance the controller handle is moved forward or backward.

- (11). Horn. (If Equipped.)

This push-button switch, when activated, permits the operator to warn jobsite personnel when the machine is operating in the area.

- (12). Battery Condition Indicator/Hourmeter. (If Equipped.)

The battery condition indicator is a gauge that provides a visual indication of the condition of the batteries, and also includes an hourmeter to indicate the number of hours the machine has been operated.

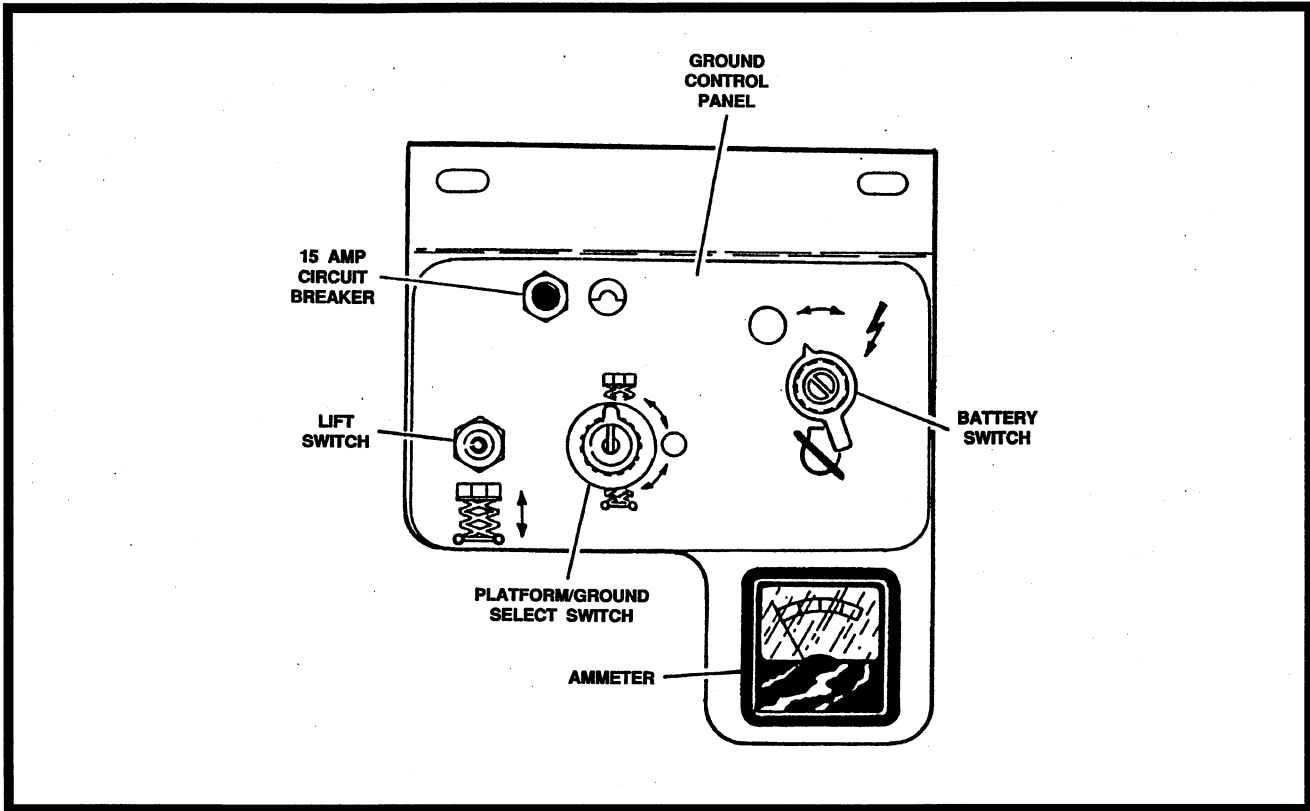
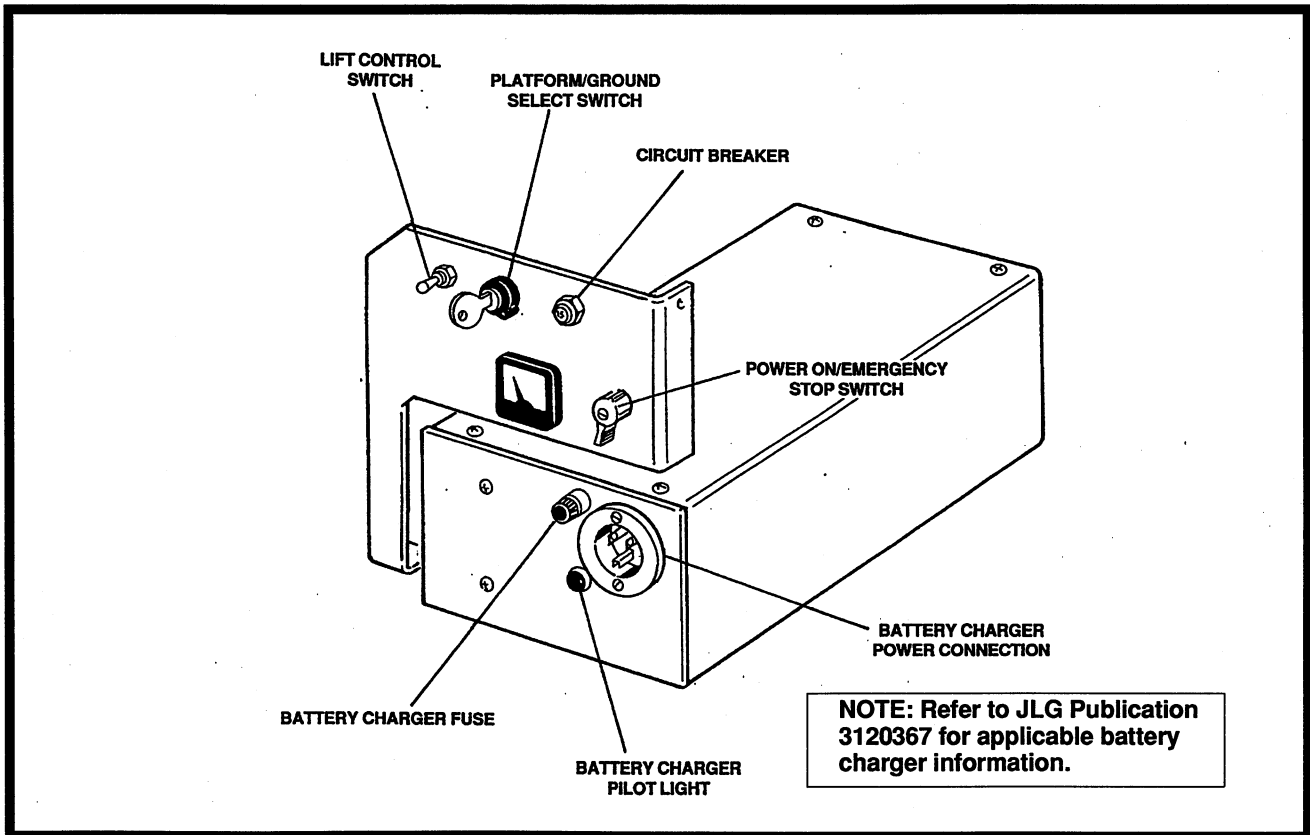

Figure 3-1. Ground Control Station - CM1432.



NOTE: Refer to JLG Publication 3120367 for applicable battery charger information.

Figure 3-2. Ground Control Station - CM2033/CM2046/CM2546/CM2558.

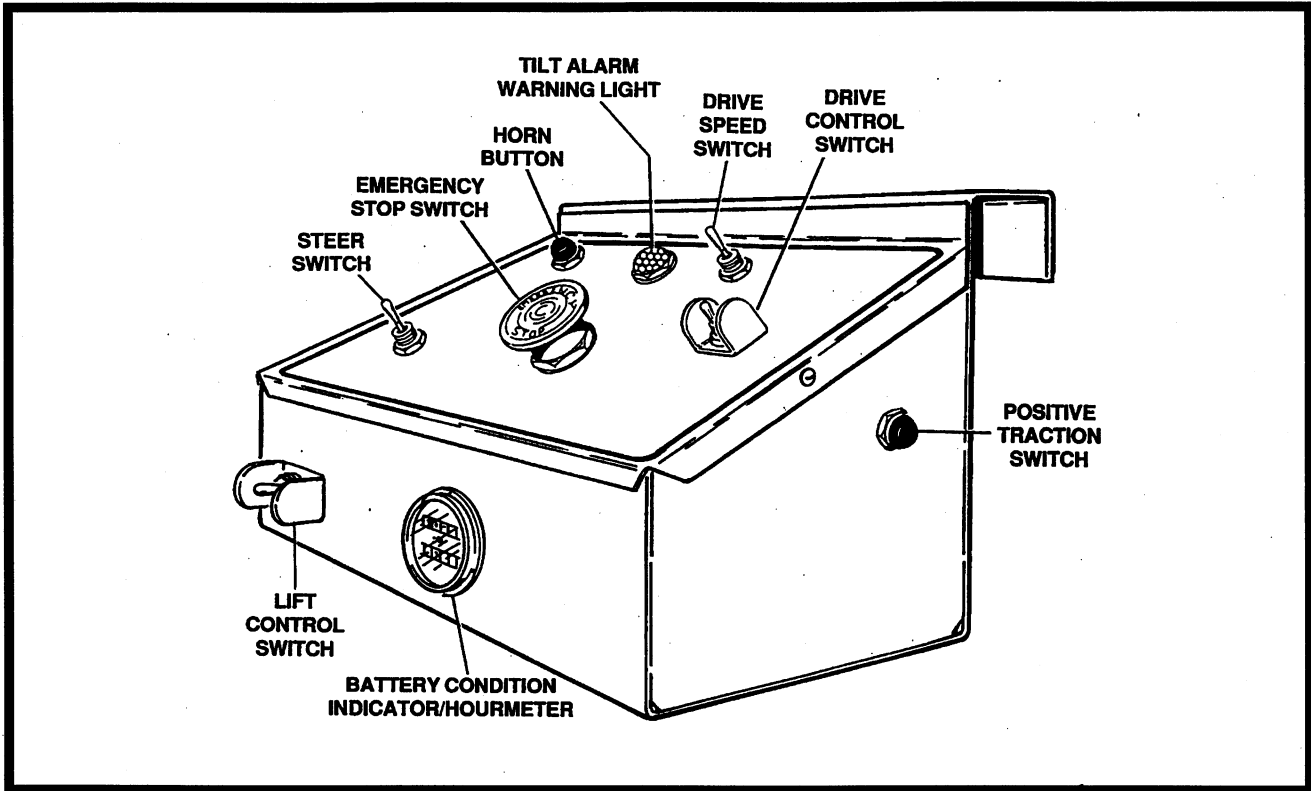

Figure 3-3. Platform Control Station w/o PQ Controller - All Models - Machines Built Before August 1992.

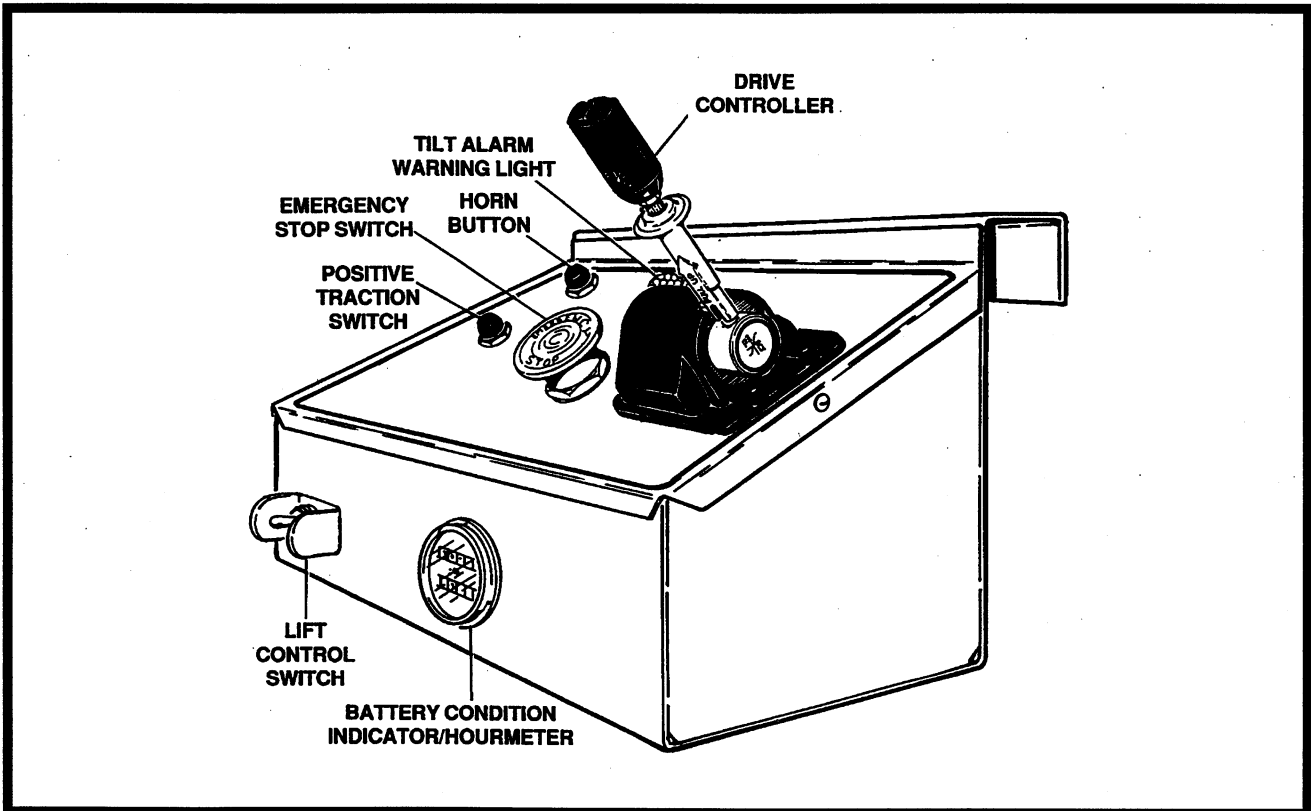

Figure 3-4. Platform Control Station w/PQ Controller - All Models - Machines Built Before August 1992.

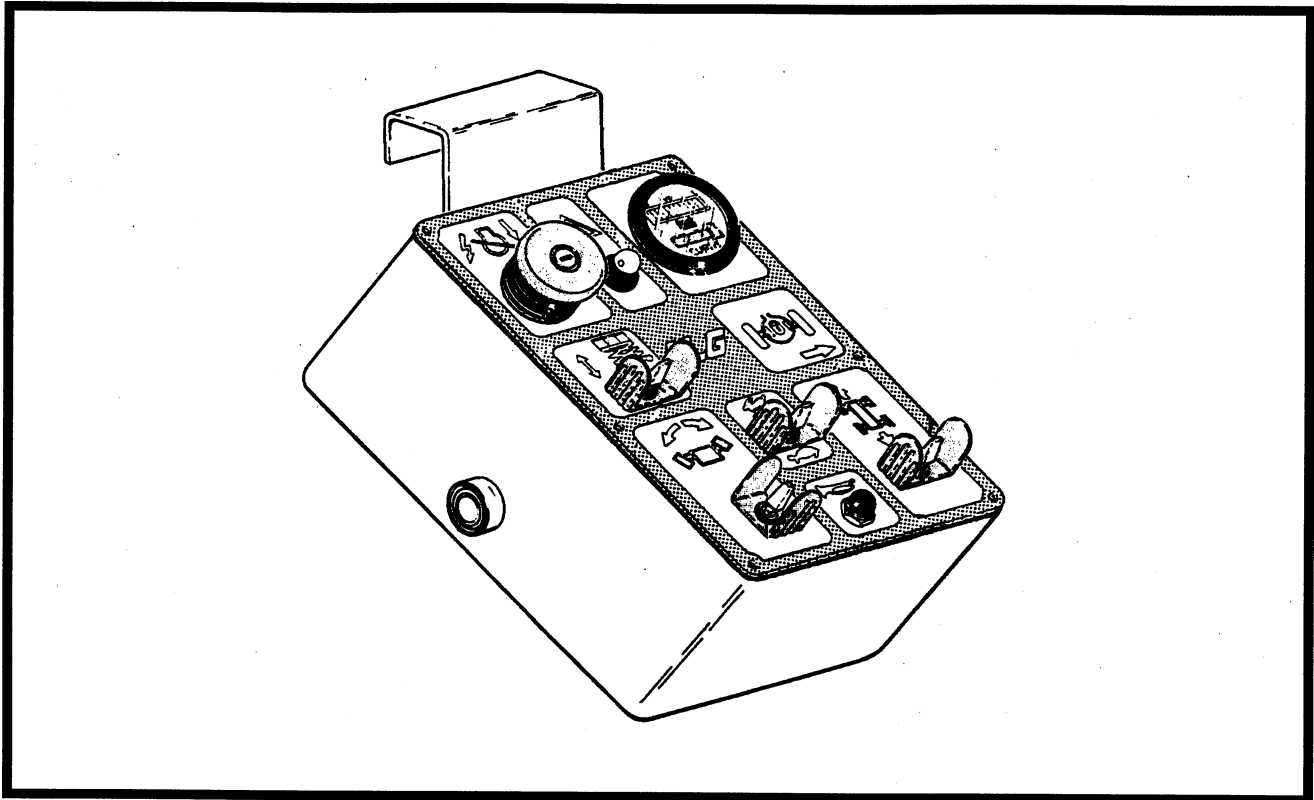

Figure 3-5. Platform Control Station w/o PQ Controller - All Models - Machines Built After August 1992.

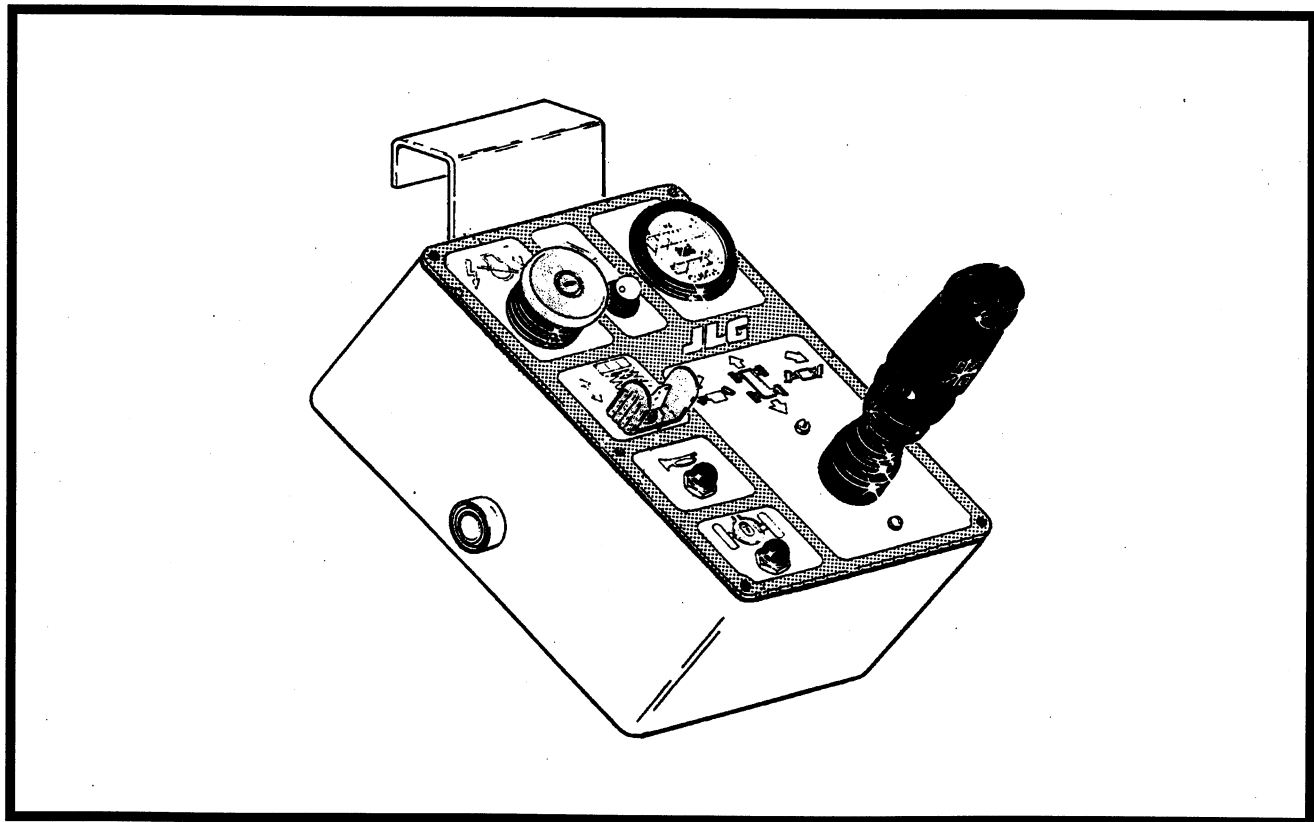

Figure 3-6. Platform Control Station w/PQ Controller - All Models - Machines Built After August 1992.

Table 3-1. Control Panel Symbols. (Sheet 1 of 3)











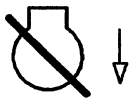







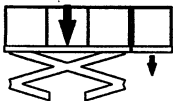

FUNCTION	SYMBOL	FUNCTION	SYMBOL
CAUTION		EMERGENCY SHUT-OFF	
CAUTION		EMERGENCY SWITCH DOWN	
CHOKE		EMERGENCY SWITCH UP	
CIRCUIT BREAKER		ENGINE SPEED	
COLD START		EXTENDABLE PLATFORM CAPACITY	
CREEP		FACTORY MUTUAL APPROVED	
CRUSHING		FAN	
DANGER		FAST	
DRIVE		FIXED PLATFORM CAPACITY	
DRIVE CUT-OUT		FUEL	
DUAL FUEL		HAND CRUSHING HAZARD	
ELECTRICAL HAZARD		HIGH ENGINE SPEED	

Table 3-1. Control Panel Symbols. (Sheet 2 of 3)

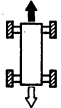
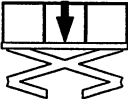
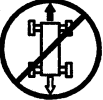









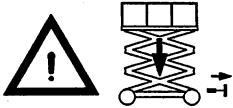



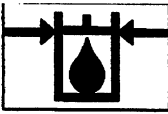

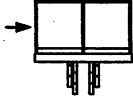
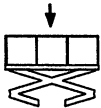
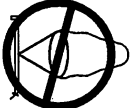
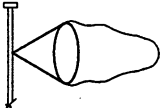
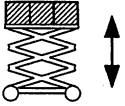

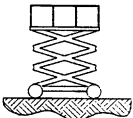

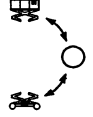

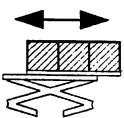
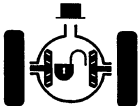

FUNCTION	SYMBOL	FUNCTION	SYMBOL
HORN		MANUAL DESCENT	
HYDRAULIC OIL		MANUAL DESCENT KNOB	
HYDRAULIC OIL LEVEL (LOW)		MASTER SWITCH	
HYDRAULIC OIL LEVEL (HIGH)		MASTER SWITCH OFF	
IGNITION		MAXIMUM PERMISSIBLE PLATFORM SIDE LOAD	
IMPORTANT (SAFETY INSTRUCTIONS)	IMPORTANT	MAXIMUM PLATFORM LOAD	
INDOOR USE ONLY		MAXIMUM WIND SPEED	
LIFT		NO TIE DOWN/LIFT	
LIFT CUT-OUT		PLATFORM ELEVATED DRIVE ON SMOOTH LEVEL SURFACE	
LP GAS		PLATFORM/GROUND SELECT	
MANUAL		PLATFORM TRAVERSE	

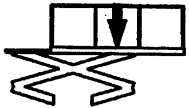
Table 3-1. Control Panel Symbols. (Sheet 3 of 3)

FUNCTION	SYMBOL	FUNCTION	SYMBOL
POSITIVE TRACTION DISENGAGED		TILT	
POSITIVE TRACTION ENGAGED		TWO WHEEL DRIVE/FOUR WHEEL DRIVE	
RESTRICTED DRIVE ON ROUGH TERRAIN		TRAVERSING PLATFORM/CAPACITY	
RESTRICTED DRIVE ON SLOPE		"UL" DOUBLE E RATED	
SLOW		WARNING	
STEER		WHEEL SPEED	
TIE DOWN/LIFT			

4-1. DESCRIPTION.

This machine is a self-propelled aerial work platform on top of an elevating 'sizzor' mechanism. The Sizzor Lift's intended purpose is to position personnel with their tools and supplies at positions above ground level. The machine can be used to reach work areas located above machinery or equipment positioned at ground level.

The JLG Sizzor Lift has a primary operator Control Station in the platform. From this Control Station, the operator can drive and steer the machine in both forward and reverse directions as well as raise and lower the platform. The machine has a Ground Control Station which will override the Platform Control Station. Ground Controls operate lift up and down and are to be used only in an emergency to lower the platform to the ground should the operator in the platform be unable to do so.

Instructions and hazard warnings are posted adjacent to both operator control stations and at other places on the machine. It is extremely important that operators know what instructions and warnings are placed on the machine, and review these periodically so that they are fresh in their minds.

The JLG Sizzor Lift is designed to provide efficient and safe operation when maintained and operated in accordance with warnings on the machine, the Operating and Safety Manual, the Service and Maintenance Manual and all jobsite and government rules and regulations. As with any type of machinery, the operator is very important to efficient and safe operation. It is absolutely necessary that the JLG Lift be regularly maintained in accordance with this manual and the machine Service and Maintenance Manual, and that any evidence of lack of maintenance, malfunction, excessive wear, damage or modification to the machine be reported immediately to the machine owner or the jobsite supervisor or safety manager and that the machine be taken out of service until all discrepancies are corrected.

The JLG Sizzor Lift is not intended to be used to lift material other than supplies which personnel in the platform require to do their job. Supplies or tools which extend outside the platform are prohibited. It must not be used as a forklift, crane, support for overhead structure, or to push or pull another object.

The JLG Sizzor Lift is powered using hydraulic motors and cylinders for the various machine motions. The hydraulic components are controlled by electrically activated hydraulic valves using switches and control levers. The speeds of functions controlled by control levers are variable from zero to maximum speed depending upon the position of the control lever. Functions controlled by

toggle switches are either on or off and higher or lower speed is possible only when the applicable high function speed control switch at the Platform Control Station is used in conjunction with the function toggle switch.

The JLG Sizzor is a two wheel drive machine with drive power being supplied by a hydraulic motor for each drive wheel. On model CM1432, the right rear wheel is supplied with a spring applied, hydraulically released brake. This brake is automatically applied any time the Drive control is returned to the neutral position. On models CM2033, CM2046, CM2546, and CM2558, both rear wheels are supplied with a spring applied, hydraulically released brake. These brakes are automatically applied any time the Drive control is returned to the neutral position.

The capacity of model CM1432 is 500 lb. (227 kg), the capacity of models CM2033 and CM2546 is 750 lb. (340 kg), and the the capacity of models CM2546 and CM 2558 is 1,000 lb. (454 kg), uniformly distributed in the center of the platform. This means that the total combined weight of personnel, tools and supplies must not exceed the above figures.

The platform may be raised only when positioned on firm, level and uniform surfaces.

4-2. GENERAL.

This section provides the necessary information needed to operate the machine. Included in this section are the procedures for starting, stopping, traveling, steering, parking, platform loading and transporting. It is important that the user read and understand the proper procedures before operating the machine.

4-3. MOTOR OPERATION.

a. Battery Switch. (CM1432) Emergency Stop Switch. (CM2033/CM2046/CM2546/CM2558)

This switch, when in the ON position, provides battery power to the Power Selector switch for all machine functions. The switch should be in the OFF position when recharging the batteries and/or parking the machine overnight.

b. Platform/Ground Select Switch. (CM1432) Power Selector Switch. (CM2033/CM2046/CM2546/CM2558)

This switch functions to direct battery power to the desired control station. With the switch in the GROUND position, battery power is supplied to the ground con-

trol station. When the switch is in the PLATFORM position, battery power is supplied to the platform control station.

Note

Some machines built before August 1992 and all machines built after August 1992 are equipped with an ENABLE switch on the platform control box. This switch must be depressed before activating DRIVE, LIFT, or STEER functions from the platform control box.

(3). Motor Activation.

With the Battery or Emergency Stop switch in the ON position, the Platform/Ground Select or Power Selector switch in the appropriate position, the Emergency Stop switch in the ON position (if operator is at platform controls) and a function switch is operated and held, the motor becomes activated and operates the desired function.

CAUTION

IF A MOTOR MALFUNCTION NECESSITATES UNSCHEDULED SHUTDOWN, DETERMINE AND CORRECT CAUSE BEFORE RESUMING ANY OPERATION.

IMPORTANT

ALWAYS POSITION BATTERY OR EMERGENCY STOP SWITCH TO THE 'OFF' POSITION WHEN MACHINE IS NOT IN USE. FAILURE TO DO SO MAY CAUSE UNNECESSARY DRAINAGE OF POWER FROM BATTERIES.

4-4. RAISING AND LOWERING. (Lifting)

WARNINGS

DO NOT RAISE PLATFORM EXCEPT ON A HARD, LEVEL SURFACE FREE OF OBSTRUCTIONS AND HOLES.

THE MACHINE IS EQUIPPED WITH A 5 DEGREES TILT SWITCH THAT CUTS OUT DRIVE AND LIFT UP FUNCTIONS, ILLUMINATES A LIGHT ON THE PLATFORM CONTROL CONSOLE, AND SOUNDS AN AUDIBLE ALARM WHEN THE MACHINE IS ON A SEVERE SLOPE (OVER 5 DEGREES) WITH THE PLATFORM RAISED. TO RESTORE DRIVE AND LIFT UP FUNCTIONS AND TURN OFF AUDIBLE ALARM, LOWER PLATFORM COMPLETELY TO STOWED POSITION. WHEN THE MACHINE IS ON A SEVERE SLOPE (OVER 5 DEGREES) WITH THE PLATFORM COMPLETELY LOWERED, ONLY THE WARNING LIGHT IS ILLUMINATED.

Note

Some machines built before August 1992 and all machines built after August 1992 are equipped with an ENABLE switch on the side of the platform control box. This switch must be depressed before activating DRIVE, LIFT, or STEER functions from the platform control box.

a. Raising.

- (1). If machine is shut down, turn Battery or Emergency Stop Switch to ON position.
- (2). Place Platform/Ground Select or Power Selector switch to appropriate position.
- (3). Position Lift switch to UP and hold until desired elevation is achieved. If equipped, depress Enable switch before activating LIFT UP function.

b. Lowering.

WARNING

ENSURE SIZZOR ARM AREA IS FREE OF PERSONNEL PRIOR TO LOWERING PLATFORM.

Position Lift switch to DOWN and hold until desired elevation is achieved or until platform is fully lowered. If equipped, depress Enable switch before activating LIFT DOWN function.

WARNING

DO NOT 'LIFT DOWN' WITHOUT COMPLETELY RETRACTING OPTIONAL EXTENDING PLATFORM.

4-5. PLATFORM EXTENSION. (If Equipped.)

The machine may be equipped with a mechanically extendable deck, which adds 3 feet (0.9 meters) to the front of the platform, giving the operator better access to worksites. To extend the deck, squeeze the release lever on the handle on the left side of the platform to release the latch and use the handle to push the extendable deck out. When the deck reaches the end of its travel, the latch will lock to hold the deck in place. To retract the deck, squeeze the release lever to release the latch and use the handle to retract the deck. Be sure the latch locks the deck in place after it is retracted. Maximum capacity of the deck extension is 250 lbs. (113 kg).

WARNING

DO NOT 'LIFT DOWN' WITHOUT COMPLETELY RETRACTING OPTIONAL EXTENDING PLATFORM.

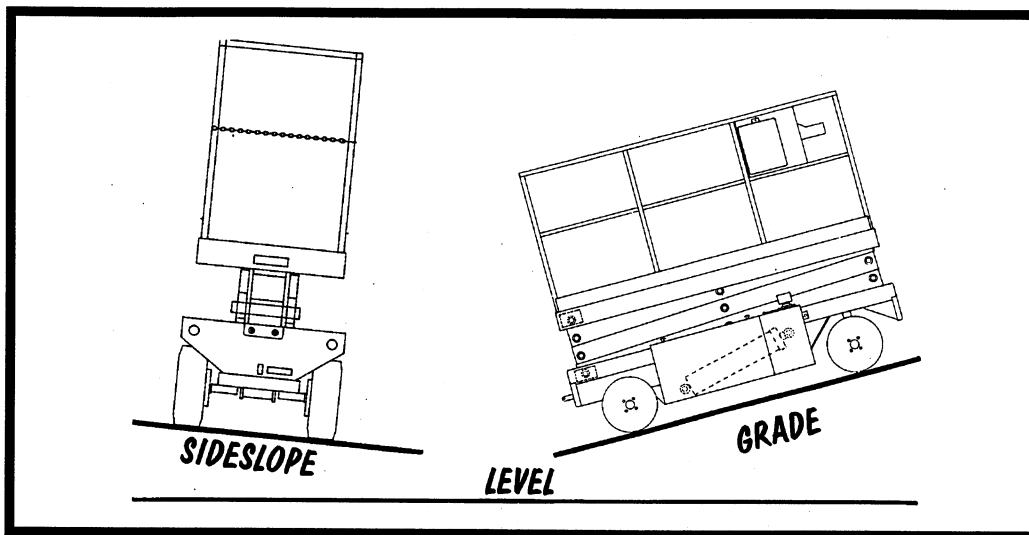

Figure 4-1. Grade and Sideslope.

4-6. STEERING.**Note**

Some machines built before August 1992 and all machines built after August 1992 are equipped with an **ENABLE** switch on the side of the platform control box. This switch must be depressed before activating **DRIVE**, **LIFT**, or **STEER** functions from the platform control box.

a. Toggle Switch Operated - w/o PQ Controller.

To steer the machine, the **STEER** toggle switch is positioned to the right for traveling right, or to the left for traveling left. If machine is equipped with an **Enable** switch, **Enable** switch must be depressed before activating **STEER** function.

When released, the switch will return to the center-off position and the wheels will remain in the previously selected position. To return the wheels to the straightened position, the switch must be activated in the opposite direction until the wheels are centered.

b. Thumb Operated - w/PQ Controller.

To steer the machine, the thumb operated steer control switch on the controller handle is positioned to the right for traveling right, or to the left for traveling left. If machine is equipped with an **Enable** switch, **Enable** switch must be depressed before activating **STEER** function.

When released, the switch will return to the center-off position and the wheels will remain in the previously selected position. To return the wheels to the straightened position, the switch must be activated in the opposite direction until the wheels are centered.

4-7. TRAVELING. (Driving) (See Figure 4-1.)**WARNINGS**

DO NOT DRIVE WITH PLATFORM RAISED EXCEPT ON A SMOOTH, FIRM AND LEVEL SURFACE FREE OF OBSTRUCTIONS AND HOLES.

TO AVOID LOSS OF TRAVEL CONTROL OR UPSET ON GRADES AND SIDESLOPES, DO NOT DRIVE MACHINE ON GRADES OR SIDESLOPES EXCEEDING THOSE SPECIFIED ON CAUTION PLACARD AT PLATFORM.

TRAVEL GRADES IN "LOW" DRIVE SPEED ONLY. USE EXTREME CAUTION WHEN DRIVING IN REVERSE AND AT ALL TIMES WHEN DRIVING WITH PLATFORM ELEVATED AND ESPECIALLY WHEN DRIVING WITH ANY PART OF MACHINE WITHIN 6 FEET (1.8 M) OF AN OBSTRUCTION.

HIGH DRIVE SPEED IS CUT OUT WHEN PLATFORM IS RAISED ABOVE STOWED POSITION.

MACHINE IS EQUIPPED WITH A 5 DEGREE TILT SWITCH THAT CUTS OUT DRIVE AND LIFT UP FUNCTIONS, ILLUMINATES A LIGHT ON THE PLATFORM CONTROL CONSOLE, AND SOUNDS AN AUDIBLE ALARM WHEN THE MACHINE IS ON A SEVERE SLOPE (OVER 5 DEGREES) WITH THE PLATFORM RAISED. TO RESTORE DRIVE AND LIFT UP FUNCTIONS AND TURN OFF ALARMS, LOWER PLATFORM COMPLETELY TO STOWED POSITION. WHEN THE MACHINE IS ON A SEVERE SLOPE (OVER 5 DEGREES) WITH THE PLATFORM COMPLETELY LOWERED, ONLY THE WARNING LIGHT IS ILLUMINATED.

Notes

Some machines built before August 1992 and all machines built after August 1992 are equipped with an **ENABLE** switch on the side of the platform control box. This switch must be depressed before activating **DRIVE**, **LIFT**, or **STEER** functions from the platform control box.

DRIVE function is cut-out when platform is raised above 17 feet (5.2 meters) on Models CM2033 and CM2046, or when platform is raised above 21 feet (6.4 meters) on Models CM2546 and CM2558. Model CM1432 is not equipped with a **DRIVE** cut-out.

b. Traveling Forward.

- (1). If machine is shut down, turn Battery or Emergency Stop switch at Ground Control Station to ON position.
- (2). Place Platform/Ground Select or Power Selector switch at ground control to **PLATFORM**.
- (3). If machine is not equipped with a PQ controller, position Drive Motor Speed switch to desired position and position Drive switch to **FORWARD** and hold for duration of travel. If machine is equipped with Enable switch, Enable switch must be depressed before activating **DRIVE** function.
- (4). If machine is equipped with a PQ controller, position control handle to **FORWARD** and hold for duration of travel. Drive speed is determined by the distance the control handle is moved from the center off position. If machine is equipped with Enable switch, Enable switch must be depressed before activating **DRIVE** function.

b. Traveling in Reverse.

- (1). If machine is shut down, turn Battery or Emergency Stop switch at Ground Control Station to ON position.
- (2). Place Platform/Ground Select or Power Selector switch at ground control to **PLATFORM**.
- (3). If machine is not equipped with a PQ controller, position Drive Motor Speed switch to desired position and position Drive switch to **REVERSE** and hold for duration of travel. If machine is equipped with Enable switch, Enable switch must be depressed before activating **DRIVE** function.
- (4). If machine is equipped with a PQ controller, position control handle to **REVERSE**

and hold for duration of travel. Drive speed is determined by the distance the control handle is moved from the center off position. If machine is equipped with Enable switch, Enable switch must be depressed before activating **DRIVE** function.

4-8. PARKING AND STOWING.**Note**

When parking battery-powered units overnight, batteries should be charged in accordance with instructions in Section 2 to ensure readiness for the following workday.

Park and stow machine as follows:

- a. Drive machine to a reasonably well-protected and well-ventilated area.
- b. Ensure platform is fully lowered.
- c. Position Battery or Emergency Stop switch to OFF position.
- d. If necessary, cover the instruction placards, caution and warning decals so that they will be protected from hostile environment.
- e. Chock at least two wheels when parking machine for an extended period of time.
- f. Turn Platform/Ground Select or Power Selector switch to OFF and remove key to disable machine from unauthorized use.

4-9. PLATFORM LOADING.**CAUTION**

MACHINE IS EQUIPPED WITH OVERLOAD PROTECTION SYSTEM THAT CUTS OUT ALL MACHINE FUNCTIONS WHEN PLATFORM IS LOADED TO 120% OF RATED CAPACITY. MACHINE FUNCTIONS ARE RESTORED WHEN OVERLOAD CONDITION IS CORRECTED.

- a. The platform maximum rated load capacity is shown on a placard located on the platform and is based upon the following criteria.
 - (1). Machine is positioned on a smooth, firm and level surface.
 - (2). All braking devices are engaged.
 - (3). Maximum capacity for each model is as follows:
 - CM1432 - 500 lb. (227 kg)
 - CM2033 - 750 lb. (340 kg)
 - CM2046 - 1,000 lb. (454 kg)
 - CM2546 - 750 lb. (340 kg)
 - CM2558 - 1,000 lb. (454 kg)

- (4). Maximum capacity of platform extension, if equipped, is 250 lb. (113 kg).
- b. It is important to remember that the load should be evenly distributed on the platform. The load should be placed near the center of the platform when possible.

4-10. SAFETY PROP.

CAUTION

SAFETY PROP MUST BE USED WHEN MAINTENANCE PERFORMED ON MACHINE REQUIRES SIZZOR ARMS TO BE RAISED.

- a. To engage safety prop, raise platform, then rotate prop clockwise until it hangs vertically. Lower the platform until the safety prop rests on the point provided on the frame. Maintenance can now begin.
- b. To store safety prop, raise platform so that prop can be rotated counterclockwise until it rests on the stop provided on the sizzor arms.

4-11. TIE DOWN AND LIFTING.

a. Tie Down.

When transporting machine, platform must be fully retracted in the stowed mode with machine securely tied down to truck or trailer deck. On models CM1432 and CM2033, three tie down eyes, one at the front of the frame and two at the rear of the frame are provided. On models CM2046, CM2546 and CM2558, four tie down eyes are provided in the frame, two at the front of the frame and two at the rear of the frame.

WARNING

USE TIE DOWN EYES ONLY TO SECURE THE MACHINE FOR SHIPPING. DO NOT USE TIE DOWN EYES TO LIFT MACHINE.

b. Lifting.

If it becomes necessary to lift the machine, a pair of forklift tubes are provided at the rear of the machine. It is very important that the forklift operator use only the designated lifting tubes to lift the machine.

Note

Forklifts must be capable of handling the following weights: CM1432 - 2,000 lb. (907 kg), CM2033 - 3,300 lb. (1,497 kg), CM2046 - 3,600 lb. (1,633 kg), CM2546 - 4,300 lb. (1,950 kg), CM2558 - 4,500 lb. (2,087 kg).

The machine may also be equipped with a lifting lug at each corner of the frame. With proper lifting equipment, these lugs may be used in lieu of the forklift tubes to lift the machine.

4-12. TOWING.

It is not recommended that this machine be towed, except in the event of an emergency such as a machine malfunction or a total machine power failure. Refer to Section 6 for emergency towing procedures.

5-1. PQ CONTROLLER.

A "multiple-step" controller is available which operates STEER and DRIVE from a single control handle.

5-2. HORN.

The warning horn is located on the frame of the machine, and is controlled by a push button switch on the platform control console. The warning horn permits the operator to warn jobsite personnel when the machine is operating in the area.

5-3. TRAVEL ALARM.

The travel alarm horn, mounted on the frame of the machine, provides an audible warning when the machine is in the travel (DRIVE) mode. It will function in FORWARD or REVERSE to warn jobsite personnel the machine is traveling.

5-4. MOTION ALARM.

The motion alarm horn, mounted on the frame of the machine, provides an audible warning when the machine is in the travel (DRIVE) or LIFT mode. It will function in FORWARD, REVERSE, LIFT UP or LIFT DOWN to warn jobsite personnel the machine is traveling or lifting.

5-5. DESCENT ALARM.

Produces an audible warning when platform LIFT control is placed in the LIFT DOWN position. The alarm warns personnel in the jobsite area to avoid the sizzor arms.

5-6. PLATFORM RECEPTACLE.

The dual receptacle is mounted on the platform kick rail. The receptacle is connected to a plug on the machine frame which can be connected to a ground receptacle.

5-7. PLATFORM WORK LIGHTS.

The two platform work lights are installed on the platform rails to provide additional lighting for the operator. Each light is equipped with an on-off switch.

5-8. NON-MARKING TIRES.

For indoor use, these tires are made from a special compound that, unlike regular tires, will not leave black skid marks on floors and other surfaces.

5-9. ROTATING BEACON.

An amber rotating beacon is installed on the machine platform rail. When the machine power is turned on, the light is activated and provides a visual warning to the machine's operation.

**5-10. HIGH OUTPUT BATTERIES.
(CM2046, CM2546 and CM2558 Only.)**

For increased operating power and reserve capacity, 370 Amp Hour batteries are available in place of the standard 240 Amp Hour batteries.

5-11. BATTERY CONDITION INDICATOR.

The battery condition indicator is a gauge that provides a visual indication of the condition of the batteries, and also includes an hourmeter to indicate the number of hours the machine has been operated.

5-12. FOLD-DOWN HAND RAILS.

The fold-down handrails enable the operator to take the machine into areas where platform height may pose a clearance problem. The fold-down hand rails give the operator an additional 10.5 inches (27 cm) clearance.

5-13. CONTROL BOX COVER.

A hinged metal cover on the platform control box, which can be pinned in place to cover the platform controls when the machine is not in use. When the pin is removed, the cover can be flipped out of the way for machine operation.

5-14. PLATFORM ACCESS DOOR.

A hinged, latching door at the aft end of the platform replaces the standard drop bar gate, giving the operator easier access to the platform.

5-15. LIFTING LUGS.

The machine may be equipped with lifting lugs, welded to the four corners of the machine frame. These lugs enable the machine to be lifted using chains or other suitable lifting devices.

6-1. GENERAL.

This section provides information on the procedures to be followed and on the systems and controls to be used in the event an emergency situation is encountered during machine operation. Prior to operation of the machine and periodically thereafter, the entire operating manual, including this section, should be reviewed by all personnel whose responsibilities include any work or contact with the machine.

6-2. EMERGENCY TOWING PROCEDURES.

a. Although towing the machine is prohibited, provisions for moving the machine, in case of a malfunction or power failure, have been incorporated. The following procedures are to be used **ONLY** for emergency movement to a suitable maintenance area.

- (1). Chock wheels securely.
- (2). Turn free-wheeling valve knob on main control valve counterclockwise all the way out.
- (3). Release parking brake as follows:
 - (a). Using a suitably sized wrench, move brake cam to horizontal position.
 - (b). Repeat step (a) for remaining brake cylinder.
- (5). Using suitable equipment for assistance, remove chocks, and move machine to an appropriate maintenance area.

b. After moving machine, complete the following procedures:

- (1). Position machine on a firm, level surface.
- (2). Chock wheels securely.
- (3). Engage parking brake as follows:
 - (a). Using a suitably sized wrench, move brake cam to vertical position.
 - (b). Repeat step (a) for remaining brake cylinder.
- (5). Turn free-wheeling valve knob on main control valve clockwise all the way in.
- (6). Remove chocks from wheels.

6-3. EMERGENCY CONTROLS AND THEIR LOCATIONS.**a. Emergency Stop Switch.**

This large red button is located on the platform control box and, when depressed, it will immediately stop the machine.

WARNING

CHECK MACHINE DAILY TO MAKE SURE EMERGENCY STOP BUTTON IS IN PLACE AND THAT GROUND CONTROL INSTRUCTIONS ARE IN PLACE AND LEGIBLE.

b. Ground Control Station.

The Ground Control Station is located on the right side of the machine frame. The controls on this panel provide the means for overriding the platform controls and for controlling the platform lift up and down functions from the ground. Place the station **SELECT SWITCH** in the **GROUND** position and operate the lift switch to lift up or down.

c. Manual Descent.

The manual descent/lift down solenoid is used, in the event of total power failure, to lower the platform using gravity. The manual descent knob is located on the machine frame, between the sizzor arms. The knob is connected, by cable, to the manual descent/lift down solenoid on the lift cylinder. Pulling the manual descent knob opens the solenoid, lowering the platform.

6-4. EMERGENCY OPERATION.**a. Use of Ground Controls.**

KNOW HOW TO USE THE GROUND CONTROLS IN AN EMERGENCY SITUATION.

Ground personnel must be thoroughly familiar with the machine operating characteristics and the ground control functions. Training should include operation of the machine, review and understanding of this section and hands-on operation of the controls in simulated emergencies.

b. Operator Unable to Control Machine.

IF THE PLATFORM OPERATOR IS PINNED, TRAPPED OR UNABLE TO OPERATE OR CONTROL THE MACHINE.

- (1). Operate the machine from ground controls **ONLY** with the assistance of other personnel and equipment (cranes, overhead

hoists, etc.) as may be required to safely remove the danger or emergency condition.

- (2). Other qualified personnel on the platform may use the platform controls with regular or auxiliary power. **DO NOT CONTINUE OPERATION IF CONTROLS DO NOT FUNCTION NORMALLY.**
- (3). Cranes, forklift trucks or other equipment which may be available are to be used to remove platform occupants and stabilize motion of the machine in case machine controls are inadequate or malfunction when used.

c. Platform Caught Overhead.

If the platform becomes jammed or snagged in overhead structures or equipment, do not continue operation of the machine from either the platform or the ground until the operator and all personnel are safely moved to a secure location. Only then should an attempt be made to free the platform using any necessary equipment and personnel. Do not operate controls to cause one or more wheels to leave the ground.

d. Righting of Tipped Machine.

A forklift of suitable capacity or equivalent equipment should be placed under the elevated side of the chassis, with a crane or other suitable lifting equipment used to lift the platform while the chassis is lowered by the forklift or other equipment.

e. Post-Incident Inspection.

Following any accident, thoroughly inspect the machine and test all functions first from the ground controls, then from the platform controls. Do not lift above 10 feet (3 meters) until you are secure that all damage has been repaired, if required, and that all controls are operating correctly.

6-5. INCIDENT NOTIFICATIONS.

- a. It is imperative that JLG Industries, Inc. be notified immediately of any incident involving a JLG product. Even if no injury or property damage is evident, the Product Safety and Reliability Department at the factory should be contacted by telephone and provided with all necessary details.
- b. It should be noted that failure to notify the Manufacturer of an incident involving a JLG Industries product within 48 hours of such an occurrence may void any warranty consideration on that particular machine.

7-1. CAPACITIES.

- **Hydraulic Oil Tank.**
 - CM1432 - 2.5 U.S. gal. (9.5 ltr.).
 - CM2033/CM2046 - 7.7 U.S. gal. (29.2 ltr.).
 - CM2546/CM2558 - 7.7 U.S. gal. (29.2 ltr.).
- **Hydraulic System. (Including Tank)**
 - CM1432 - 3.0 U.S. gal. (11.4 ltr.).
 - CM2033/CM2046 - 9.2 U.S. gal. (34.8 ltr.).
 - CM2546/CM2558 - 9.2 U.S. gal. (34.8 ltr.).

7-2. COMPONENT DATA.

- **Hydraulic Pump/Electric Motor Assembly. (All Models)**
 - 24 Volt DC motor.
 - 2 section gear pump - 3.13 gpm (11.84 lpm) output each section.
- **Battery Charger. (All Models)**
 - 24 Volts DC - 25 Amp output w/auto timer.
- **Batteries (4).**
 - CM1432 - 6 Volt, 137 minutes reserve power @ 75 Amps.
 - Standard - CM2033/CM2046/CM2546/CM2558 - 6 Volt, 245 Amp hour (20 hour rate).
 - High Output - CM2046/CM2546/CM2558 Only - 6 Volt, 370 Amp hour (20 hour rate).
- **Steer/Drive System.**
 - Tires.
 - Standard - CM1432 - 4.00 x 8 - 2.5 Solid - Rib.
 - Standard - CM2033/CM2046/CM2546/CM2558 - 5 x 8 - 3.75 Solid - Rib.
 - Optional - All Models - 5 x 8 - 3.75 Solid, Non-Marking.
 - Parking Brake - All models - Dual cylinder, hydraulically applied and released.
 - Drive Motor.
 - CM1432/CM2033/CM2046 - 11.9 in.³ (195 cm³) displacement.
 - CM2546/CM2558 - 14.9 in.³ (244 cm³) displacement.
- **Rear Wheels and Tires.**
 - Tires.
 - Standard - CM1432 - 4.00 x 8 - 2.5 Solid - Rib
 - Standard - CM2033/CM2046/CM2546/CM2558 - 5 x 8 - 3.75 Solid - Rib.
 - Optional - All Models - 5 x 8 - 3.75 Solid, Non-Marking.

- **Hydraulic Filter - In-line. (All Models)**
 - Return - Bypass Type.
 - 25 Microns Nominal.

7-3. PERFORMANCE DATA.

- **Travel Speed.**
 - CM1432 - 2.5 mph (4.0 kmh).
 - CM2033/CM2046 - 2.75 mph (4.4 kmh).
 - CM2546/CM2558 - 2.25 mph (3.6 kmh).
- **Gradeability.**
 - CM1432 - 25%.
 - CM2033/CM2046 - 25%.
 - CM2546/CM2558 - 25%.
- **Turning Radius (Outside).**
 - CM1432 - 60.1 in. (1.5 m).
 - CM2033 - 87 in. (2.2 m).
 - CM2046 - 102.6 in. (2.6 m).
 - CM2546 - 102.6 in. (2.6 m).
 - CM2558 - 105 in. (2.7 m).
- **Lift.**
 - CM1432.
 - Up - 12-16 seconds.
 - Down - 25-30 seconds.
 - CM2033/CM2046.
 - Up - 25-30 seconds.
 - Down - 25-30 seconds.
 - CM2546/CM2558.
 - Up - 30-35 seconds.
 - Down - 30-35 seconds.
- **Platform Capacity.**
 - CM1432 - 500 lb. (227 kg).
 - CM2033/CM2546 - 750 lb. (340 kg).
 - CM2046/CM2558 - 1,000 lb. (454 kg).
- **Platform Extension Capacity.**
 - CM1432 - 250 lb. (113 kg).
 - CM2033/CM2046 - 250 lb. (113 kg).
 - CM2546/CM2558 - 250 lb. (113 kg).
- **Machine Weight.**
 - CM1432 - approx. 2,000 lb. (907 kg).
 - CM2033 - approx. 3,210 lb. (1,456 kg).
 - CM2046 - approx. 3,780 lb. (1,715 kg).
 - CM2546 - approx. 4,360 lb. (1,978 kg).
 - CM2558 - approx. 4,630 lb. (2,100 kg).
- **Machine Height (Platform Lowered).**
 - CM1432 - 38.0 in. (1.0 m).
 - CM2033 - 39.12 in. (1.0 m).
 - CM2046 - 40.12 in. (1.0 m).
 - CM2546 - 45.5 in. (1.2 m).
 - CM2558 - 45.5 in. (1.2 m).

- **Machine Length.**
 - CM1432 - 65.0 in. (1.7 m).
 - CM2033 - 101.5 in. (2.6 m).
 - CM2046 - 101.5 in. (2.6 m).
 - CM2546 - 101.5 in. (2.6 m).
 - CM2558 - 101.5 in. (2.6 m).
- **Machine Width.**
 - CM1432 w/Standard Tires - 32.3 in. (0.8 m).
 - CM2033 w/Standard Tires - 33 in. (0.8 m).
 - CM2046 w/Standard Tires - 46 in. (1.2 m).
 - CM2546 w/Standard Tires - 46 in. (1.2 m).
 - CM2558 w/Standard Tires - 58 in. (1.5 m).

7-4. TORQUE REQUIREMENTS.

Description	Torque Value (Dry)	Interval Hours
A. Wheel Lugs (All Models)	90 ft lb (12.4 kgm)	50
B. Wheel Hub Attach Nut to Drive Motor Shaft (CM1432)	125-150 ft lb (17-21 kgm)	200/500*
C. Drive Hub To Drive Motor (CM2033/CM2046/CM2546/CM2558)	125-150 ft lb (17-21 kgm)	200/500*

Note

When maintenance becomes necessary or a fastener has loosened, refer to the Torque Chart Figure 7-1 to determine proper torque value.

7-5. LUBRICATION.

- **Hydraulic Oil.**

Table 7-1. Hydraulic Oil.

HYDRAULIC SYSTEM OPERATING TEMPERATURE RANGE	SAE VISCOSITY GRADE
0° F to +23° F (-18° C to -5° C)	10W
0° F to +210° F (-18° C to +99° C)	10W-20,10W-30
50° F to 210° F (+10° C to +210° C)	20W-20

Note

Hydraulic oils must have anti-wear qualities at least to API Service Classification GL-3, and sufficient chemical stability for mobile hydraulic system service. JLG Industries recommends Kendall Hyken 052 hydraulic oil, which has an SAE viscosity of 10W-20 and viscosity index of 152.

Notes

When temperatures remain consistently below -20° F (-7° C), an amount of no. 2 diesel fuel, not to exceed 20% of system capacity, may be added to the hydraulic oil reservoir. This diesel fuel will "thin" the hydraulic oil for easier cold weather operation, and will almost completely dissipate from the hydraulic system over a several month period of time. When cold weather is past, it may be necessary to drain and refill the hydraulic system to rid the system of any remaining diesel fuel.

Aside from JLG recommendations, it is not advisable to mix oils of different brands or types, as they may not contain the same required additives or be of comparable viscosities. If use of hydraulic oil other than Kendall Hyken 052 is desired, contact JLG Industries for proper recommendations.

- **Lubrication Specifications.**

Table 7-2. Lubrication Specifications.

KEY	SPECIFICATIONS
MPG	Multipurpose Grease having a minimum dripping point of 350° F. Excellent water resistance and adhesive qualities, and being of extreme pressure type. (Timken OK 40 pounds minimum.)
EPGL	Extreme Pressure Gear Lube (oil) meeting API service classification GL-5 or MIL-Spec MIL-L-2105.
HO	Hydraulic Oil. API service classification GL-3, e.g. Kendall Hyken 052.

Note

Refer to Figures 7-2 and 7-3 for specific lubrication procedures.

7-6. CYLINDER SPECIFICATIONS.

Note

All dimensions are given in inches (in), with the metric equivalent, centimeters (cm), given in parentheses.

DESCRIPTION	BORE	STROKE	ROD DIA.
Lift Cylinder - CM1432	2.50 (6.3)	27.56 (70.0)	1.50 (3.8)
Lift Cylinder - CM2033/CM2046	3.00 (5.1)	49.38 (125.4)	2.00 (5.1)
Lift Cylinder - CM2546/CM2558	3.50 (8.9)	47.25 (120.0)	2.50 (6.4)
Steer Cylinder - Double Rod - All Models	2.00 (5.1)	2.75 (7.0)	1.25 (3.8)
		each rod	
Cushion Cylinder (Accumulator) - CM1432	1.50 (3.8)	6.13 (15.6)	n/a
Cushion Cylinder (Accumulator) - CM2033/CM2046/CM2546/CM2558	2.00 (5.1)	6.13 (15.6)	n/a
Parking Brake Cylinder - All Models	1.75 (4.4)	0.88 (2.2)	1.13 (2.9)

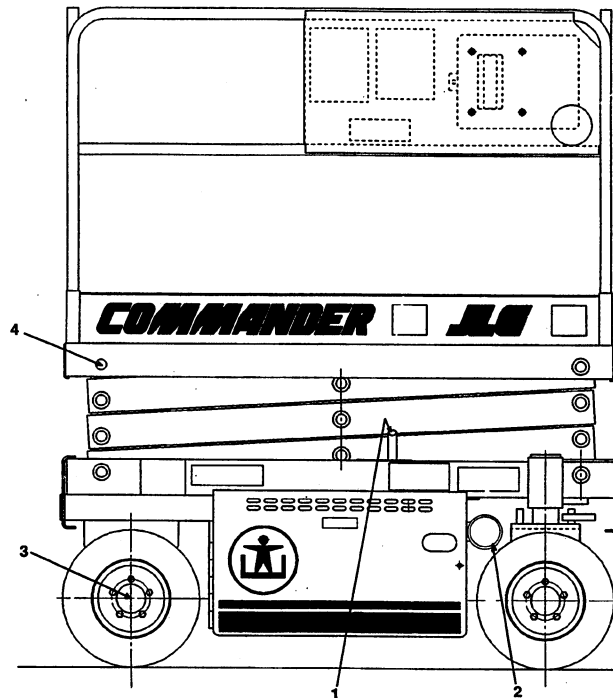

INDEX NUMBER	COMPONENT	NO/TYPE LUBE POINTS	LUBE/METHOD	INTERVAL HOURS	COMMENTS
1	Hydraulic Oil	Dipstick/Fill Tube/ Drain Plug	HO - Check HO Level (See Note 4) HO - Change HO	10/2000	Check oil every 10 hrs. Change oil every 2000 hrs.
2	Hydraulic Filter Element	N/A	N/A	40/250	Change filter after first 40 hours of operation, then every 250 hours thereafter.
3	Wheel Bearings	2 - Rear Wheels	MPG - Repack	2000	N/A
4	Platform Sliding Block Pads	8 Wear Pads	MPG - Brush	50	N/A
7	Kingpin Housing	2 Grease Fittings	MPG - Pressure Gun	50	N/A

Key To Lubricants:

- MPG - Multi-Purpose Grease
- HO - Hydraulic Oil - Kendall Hyken 052

WARNING

TO AVOID PERSONAL INJURY, USE SAFETY PROP FOR ALL MAINTENANCE REQUIRING PLATFORM TO BE ELEVATED.

Notes:

1. Be sure to lubricate like items on each side of machine.
2. Recommended lubricating intervals are based on normal use. If machine is subjected to severe operating conditions, user must adjust lubricating requirements accordingly.
3. Lubricating intervals are calculated on 50 hours of machine operation per week.
4. Prior to checking hydraulic oil level, operate machine through one complete cycle of lift function (full up and down). Failure to do so will result in incorrect oil level reading on hydraulic tank.
5. When lift cylinder is removed from machine, coat inside of rod end barrel end bushings with Gredag 714 grease prior to installation of lift cylinder attach pins. When installing attach pins, be sure not to dislodge or damage o-rings inside bushings.

Figure 7-2. Lubrication Chart - CM1432.

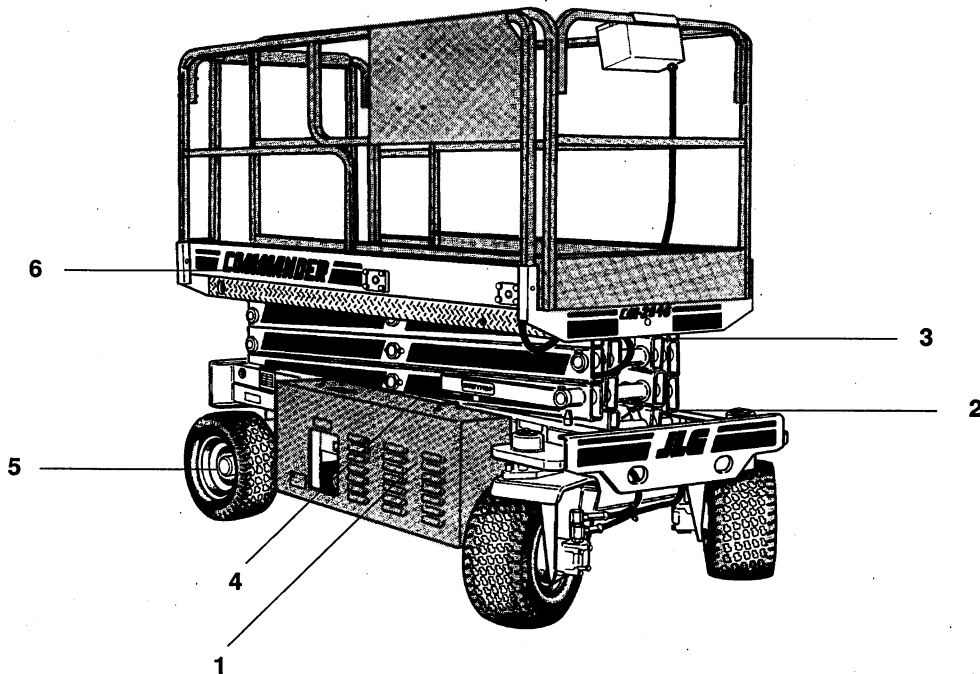

INDEX NUMBER	COMPONENT	NO/TYPE LUBE POINTS	LUBE/METHOD	INTERVAL HOURS	COMMENTS
1	Hydraulic Oil	Fill Cap/Drain Plug	HO - Check HO Level (See Note 4) HO - Change HO	10/2000	Check oil every 10 hrs. Change oil every 2000 hrs.
2	Hydraulic Filter Element	N/A	N/A	40/250	Change filter after first 40 hours of operation, then every 250 hours thereafter.
3	Lift Cylinder - Rod End	1 Grease Fitting	MPG - Pressure Gun	50	N/A
4	Lift Cylinder - Barrel End	1 Grease Fitting	MPG - Pressure Gun	50	N/A
5	Wheel Bearings	2 - Rear Wheels	MPG - Repack	2000	N/A
6	Platform Sliding Block Pads	8 Wear Pads	MPG - Brush	50	N/A

Key To Lubricants:

MPG - Multi-Purpose Grease
HO - Hydraulic Oil - Kendall Hyken 052

WARNING

TO AVOID PERSONAL INJURY, USE SAFETY PROP FOR ALL MAINTENANCE REQUIRING PLATFORM TO BE ELEVATED.

Notes:

1. Be sure to lubricate like items on each side of machine.
2. Recommended lubricating intervals are based on normal use. If machine is subjected to severe operating conditions, user must adjust lubricating requirements accordingly.
3. Lubricating intervals are calculated on 50 hours of machine operation per week.
4. Prior to checking hydraulic oil level, operate machine through one complete cycle of lift function (full up and down). Failure to do so will result in incorrect oil level reading on hydraulic tank.

Figure 7-3. Lubrication Chart - CM2033/CM2046/CM2546/CM2558.

7-7. PRESSURE SETTINGS.

Note

All pressures are given in pounds per square inch (PSI), with the metric equivalent, bar, given in parentheses.

On machines built prior to June 1993, Lift is controlled by P2. On machines built after June 1993, a separate Lift relief is provided.

- **All Models - Standard Machine.**
 - Main Relief - P1 - 2700 (186).
 - Main Relief - P2 - 2700 (186).
 - Steer Relief - 1500 (103).
 - Hi-Drive Sequence - 1100 (76).
 - Lift Relief.
 - CM1432 - 2200 (152).
 - CM1432 Plus - Consult Factory.
 - CM1732 - 2300 (159).
 - CM2033 - 1800 (124).
 - CM2046 - 2150 (148).
 - CM2546 - 2050 (141).
 - CM2558 - 2300 (159).

- **All Models - Machine with Proportional Drive.**
 - Main Relief - P1 - 2700 (186).
 - Main Relief - P2 - 2700 (186).
 - Steer Relief - 1500 (103).
 - Hi-Drive Sequence - 1100 (76).
 - Lift Relief.
 - CM1432 - 2200 (152).
 - CM1432 Plus - Consult Factory.
 - CM1732 - 2300 (159).
 - CM2033 - 1800 (124).
 - CM2046 - 2150 (148).
 - CM2546 - 2050 (141).
 - CM2558 - 2300 (159).

**7-8. SERIAL NUMBER LOCATIONS.
(See Figures 7-4 and 7-5.)**

For machine identification, a serial number plate is affixed to the machine. On model CM1432 the plate is located on the right front side of the machine frame, just behind the right front steer spindle. In addition, if the serial number plate is damaged or missing, the machine serial number is stamped on the right front top of the frame, in front of the right front steer spindle. On models CM2033, CM2046, CM2546 and CM2558, the plate is located on the rear bumper of the machine frame. In addition, if the serial number plate is damaged or missing, the machine serial number is stamped on the right front of the frame, near the steering spindle and bushing.

7-9. LIMIT SWITCHES.

The machines are equipped with the following limit switches:

- Drive Cut-Out (w/non-marking tires) - Drive function is cut out when platform is raised above 17 feet (5.2 meters) on Models CM2033 and CM2046, or when platform is raised above 21 feet (6.4 meters) on Models CM2546 and CM2558. Model CM1432 is not equipped with a DRIVE cut-out.
- High Drive Cut-Out - High drive speed is cut out when platform is raised above stowed position.
- Tilt Alarm - 5 degrees - Illuminates light on platform, sounds alarm, and cuts out DRIVE and LIFT UP functions when machine is 5 degrees out of level in any direction.
- Platform Overload Cut-Out - All machine functions, except LIFT DOWN, are cut-out when platform is loaded to 120% of rated capacity (see paragraph 7-3). Functions are restored when overload condition is corrected.

7-10. MAJOR COMPONENT WEIGHTS.

COMPONENT	LB (KG)
Platform (30" x 64") - CM1432	147 (67)
Platform (30" x 94") - CM2033.	345 (157)
Platform (42" x 94") - CM2046/CM2546.	495 (225)
Platform (54" x 94") - CM2558.	650 (295)
Platform Extension - All Models.	110 (50)
Arm Assembly - CM1432 (Includes Lift Cylinder)	540 (245)
Arm Assembly - CM2033/CM2046. (Includes Lift Cylinder)	1300 (590)
Arm Assembly - CM2546/CM2558. (Includes Lift Cylinder)	1800 (817)
Chassis - CM1432 w/Solid Tires	1203 (546)
Chassis - CM2033 w/Solid Tires.	1480 (671)
Chassis - CM2046 w/Solid Tires	1800 (817)
Chassis - CM2546 w/Solid Tires.	1800 (817)
Chassis - CM2558 w/Solid Tires.	1940 (880)

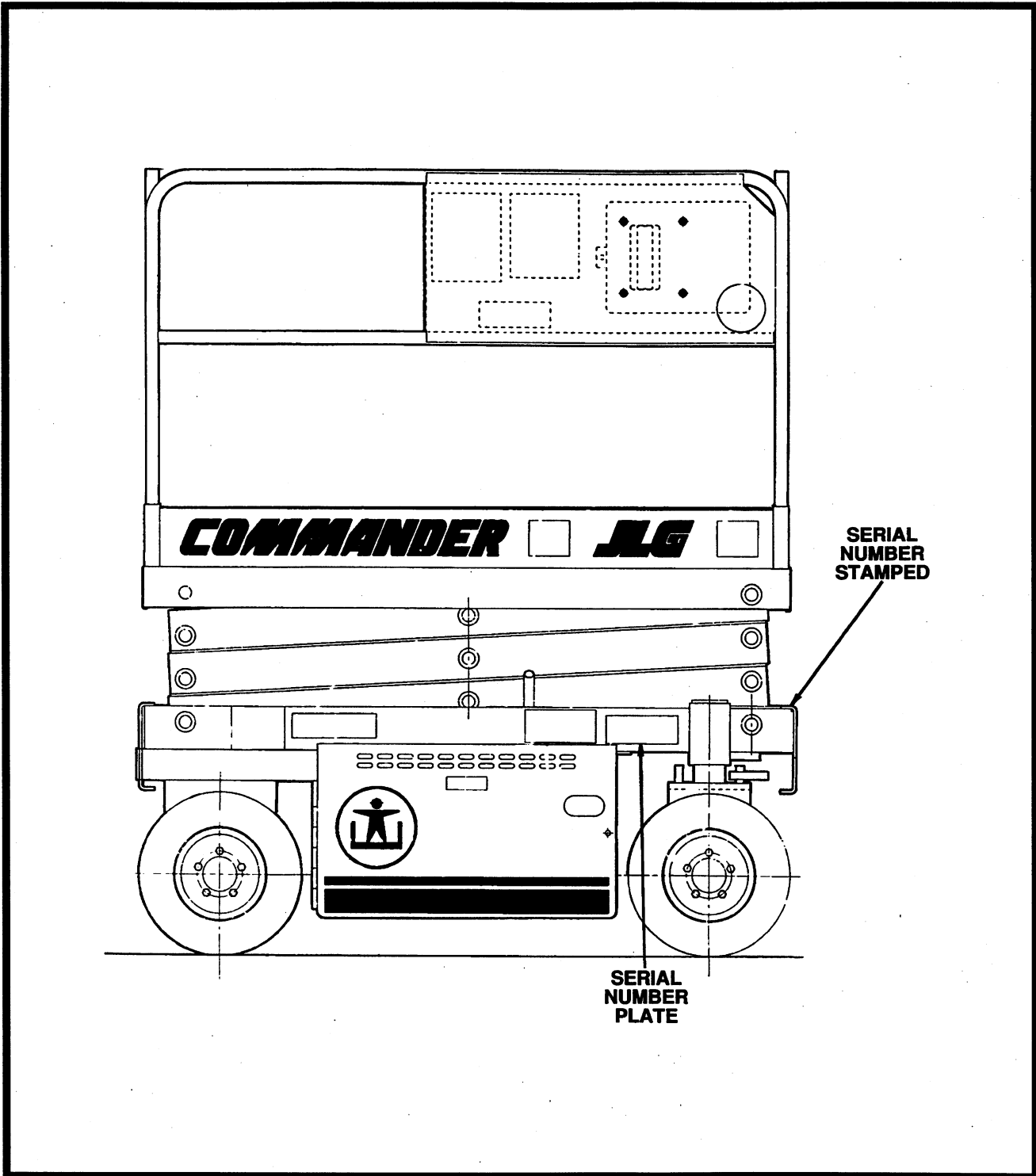

Figure 7-4. Serial Number Locations - CM1432.

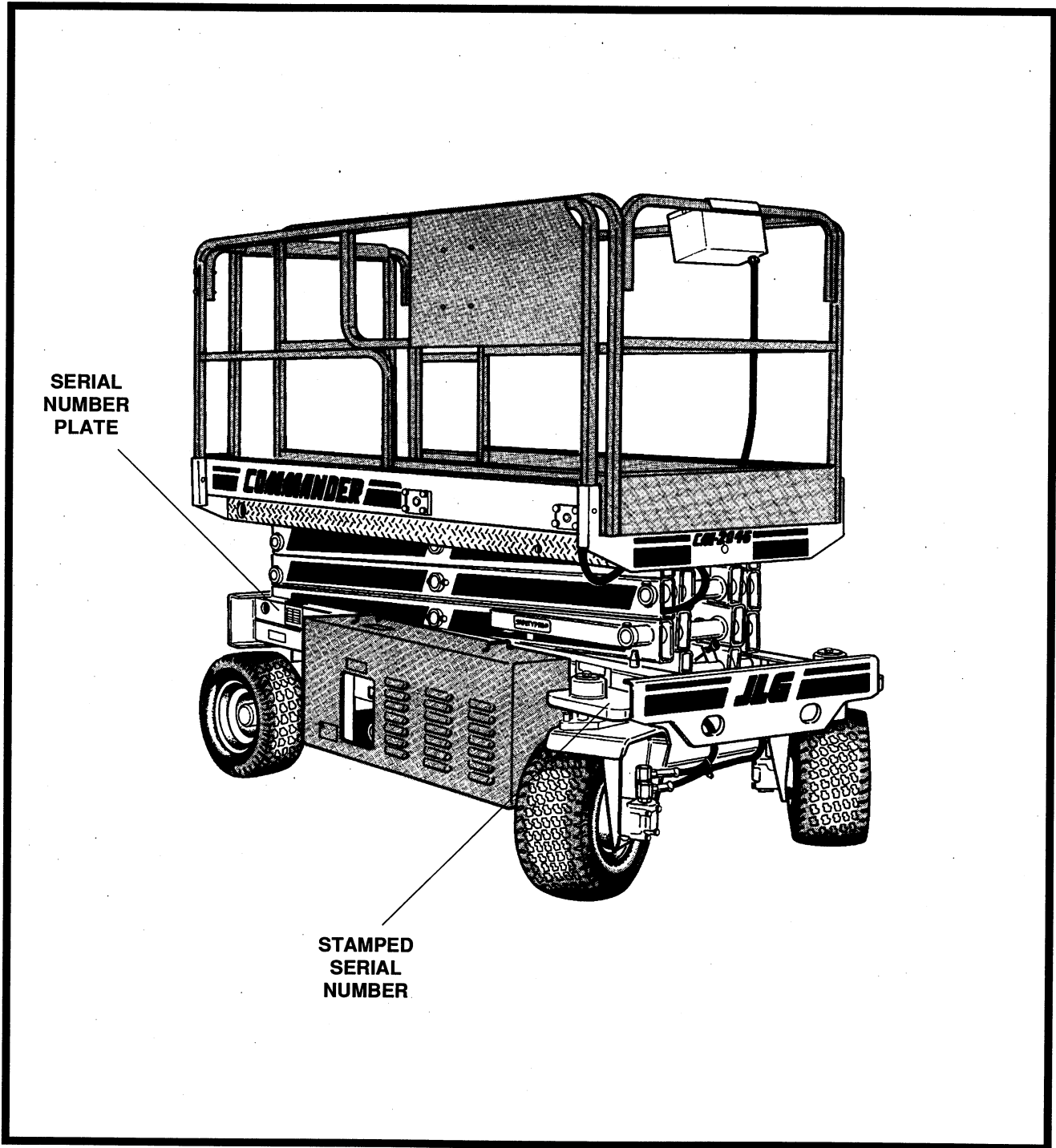

Figure 7-5. Serial Number Locations - CM2033/CM3046/CM2546/CM2558.

8-1. GENERAL.

- a. This section provides information necessary to perform maintenance on the sizzor lift. Descriptions, techniques and specific procedures are designed to provide the safest and most efficient maintenance for use by personnel responsible for ensuring the correct installation and operation of machine components and systems.

Note

Maintenance procedures provided in this section apply to all five sizzor lift models covered in this manual. Procedures that apply to a specific model will be so noted.

CAUTION

WHEN AN ABNORMAL CONDITION IS NOTED AND PROCEDURES CONTAINED HEREIN DO NOT SPECIFICALLY RELATE TO THE NOTED IRREGULARITY, WORK SHOULD BE STOPPED AND TECHNICALLY QUALIFIED GUIDANCE OBTAINED BEFORE WORK IS RESUMED.

- b. The maintenance procedures included consist of servicing and component removal and installation, disassembly and assembly, inspection, lubrication and cleaning. Information on any special tools or test equipment is also provided where applicable.

8-2. SERVICING AND MAINTENANCE GUIDELINES.**a. General.**

The following information is provided to assist you in the use and application of servicing and maintenance procedures contained in this chapter.

b. Safety and Workmanship.

Your safety, and that of others, is the first consideration when engaging in the maintenance of equipment. Always be conscious of weight. Never attempt to move heavy parts without the aid of a mechanical device. Do not allow heavy objects to rest in an unstable position. When raising a portion of the equipment, ensure that adequate support is provided.

c. Cleanliness.

- (1). The most important single item in preserving the long service life of a machine is to keep dirt and foreign materials out of the vital components. Precautions have been taken to safeguard against this. Shields, covers, seals, and filters are provided to

keep air, fuel, and oil supplies clean; however, these items must be maintained on a scheduled basis in order to function properly.

- (2). At any time when air, fuel, or oil lines are disconnected, clear adjacent areas as well as the openings and fittings themselves. As soon as a line or component is disconnected, cap or cover all openings to prevent entry of foreign matter.
- (3). Clean and inspect all parts during servicing or maintenance, and assure that all passages and openings are unobstructed. Cover all parts to keep them clean. Be sure all parts are clean before they are installed. New parts should remain in their containers until they are ready to be used.

d. Components Removal and Installation.

- (1). Use adjustable lifting devices, whenever possible, if mechanical assistance is required. All slings (chains, cables, etc.) should be parallel to each other and as near perpendicular as possible to top of part being lifted.
- (2). Should it be necessary to remove a component on an angle, keep in mind that the capacity of an eyebolt or similar bracket lessens, as the angle between the supporting structure and the component becomes less than 90 degrees.
- (3). If a part resists removal, check to see whether all nuts, bolts, cables, brackets, wiring, etc., have been removed and that no adjacent parts are interfering.

e. Component Disassembly and Reassembly.

When disassembling or reassembling a component, complete the procedural steps in sequence. Do not partially disassemble or assemble one part, then start on another. Always recheck your work to assure that nothing has been overlooked. Do not make any adjustments, other than those recommended, without obtaining proper approval.

f. Pressure-Fit Parts.

When assembling pressure-fit parts, use an "anti-seize" or molybdenum disulfide base compound to lubricate the mating surface.

g. Bearings.

- (1). When a bearing is removed, cover it to keep out dirt and abrasives. Clean bear-

ings in nonflammable cleaning solvent and allow to drip dry. Compressed air can be used but do not spin the bearing.

- (2). Discard bearings if the races and balls (or rollers) are pitted, scored, or burned.
- (3). If bearing is found to be serviceable, apply a light coat of oil and wrap it in clean (waxed) paper. Do not unwrap reusable or new bearings until they are ready to install.
- (4). Lubricate new or used serviceable bearings before installation. When pressing a bearing into a retainer or bore, apply pressure to the outer race. If the bearing is to be installed on a shaft, apply pressure to the inner race.

h. Gaskets.

Check that holes in gaskets align with openings in the mating parts. If it becomes necessary to hand-fabricate a gasket, use gasket material or stock of equivalent material and thickness. Be sure to cut holes in the right location, as blank gaskets can cause serious system damage.

i. Bolt Usage and Torque Application.

- (1). Use bolts of proper length. A bolt which is too long will bottom before the head is tight against its related part. If a bolt is too short, there will not be enough thread area to engage and hold the part properly. When replacing bolts, use only those having the same specifications of the original, or one which is equivalent.
- (2). Unless specific torque requirements are given within the text, standard torque values should be used on heat-treated bolts, studs, and steel nuts, in accordance with recommended shop practices. (See Figure 7-1.)

j. Hydraulic Lines and Electrical Wiring.

Clearly mark or tag hydraulic lines and electrical wiring, as well as their receptacles, when disconnecting or removing them from the unit. This will assure that they are correctly reinstalled.

k. Hydraulic System.

- (1). Keep the system clean. If evidence of metal or rubber particles is found in the hydraulic system, drain and flush the entire system.
- (2). Disassemble and reassemble parts on clean work surface. Clean all metal parts

with non-flammable cleaning solvent. Lubricate components, as required, to aid assembly.

l. Lubrication.

Service applicable components with the amount, type, and grade of lubricant recommended in this manual, at the specified intervals. When recommended lubricants are not available, consult your local supplier for an equivalent that meets or exceeds the specifications listed.

m. Batteries.

Clean batteries, using a non-metallic brush and a solution of baking soda and water. Rinse with clean water. After cleaning, thoroughly dry batteries and coat terminals with an anti-corrosion compound.

n. Lubrication and Servicing.

Components and assemblies requiring lubrication and servicing are shown in Figure 7-2.

8-3. LUBRICATION INFORMATION.

a. Hydraulic System.

- (1). The primary enemy of a hydraulic system is contamination. Contaminants enter the system by various means, e.g., using inadequate hydraulic oil, allowing moisture, grease, filings, sealing components, sand, etc., to enter when performing maintenance, or by permitting the pump to cavitate due to insufficient system warm-up or leaks in the pump supply (suction) lines.
- (2). The design and manufacturing tolerances of the component working parts are very close, therefore, even the smallest amount of dirt or foreign matter entering a system can cause wear or damage to the components and generally results in faulty operation. Every precaution must be taken to keep hydraulic oil clean, including reserve oil in storage. Hydraulic system filters should be checked, cleaned, and/or replaced as necessary, at the specified intervals required in Figure 7-2. Always examine filters for evidence of metal particles.
- (3). Cloudy oils indicate a high moisture content which permits organic growth, resulting in oxidation or corrosion. If this condition occurs, the system must be drained, flushed, and refilled with clean oil.

- (4). It is not advisable to mix oils of different brands or types, as they may not contain the same required additives or be of comparable viscosities. Good grade mineral oils, with viscosities suited to the ambient temperatures in which the machine is operating, are recommended for use.

Note

Metal particles may appear in the oil or filters of new machines due to the wear-in of meshing components.

b. Hydraulic Oil.

- (1). Refer to Table 7-1 for recommendations for viscosity ranges.
- (2). JLG recommends Kendall Hyken 052 hydraulic oil, which has an SAE viscosity of 10W-20 and a viscosity index of 152.

Note

Start-up of hydraulic system with oil temperatures below -15 degrees F (-26 degrees C) is not recommended. If it is necessary to start the system in a sub-zero environment, it will be necessary to heat the oil with a low density, 100VAC heater to a minimum temperature of -15 degrees F (-26 degrees C).

- (3). The only exception to the above is to drain and fill the system with Mobil DTE 11 oil or its equivalent. This will allow start up at temperatures down to -20 degrees F (-29 degrees C). However, use of this oil will give poor performance at temperatures above 120 degrees F (49 degrees C). Systems using DTE 11 oil should not be operated at temperatures above 200 degrees F (94 degrees C) under any condition.

c. Changing Hydraulic Oil.

- (1). Use of any of the recommended crankcase or hydraulic oils eliminates the need for changing the oil on a regular basis. However, filter elements must be changed after the first 40 hours of operation and every 250 hours thereafter. If it is necessary to change the oil, use only those oils meeting or exceeding the specifications appearing in this manual. If unable to obtain the same type of oil supplied with the machine, consult local supplier for assistance in selecting the proper equivalent. Avoid mixing petroleum and synthetic base oils. JLG Industries recommends changing the hydraulic oil annually.
- (2). Use every precaution to keep the hydraulic oil clean. If the oil must be

poured from the original container into another, be sure to clean all possible contaminants from the service container. Always clean the mesh element of the filter and replace the cartridge any time the system oil is changed.

- (3). While the unit is shut down, a good preventive maintenance measure is to make a thorough inspection of all hydraulic components, lines, fittings, etc., as well as a functional check of each system, before placing the machine back in service.

d. Lubrication Specifications.

Specified lubricants, as recommended by the component manufacturers, are always the best choice, however, multi-purpose greases usually have the qualities which meet a variety of single purpose grease requirements. Should any question arise regarding the use of greases in maintenance stock, consult your local supplier for evaluation. Refer to Table 7-2 for an explanation of the lubricant key designations appearing in the Lubrication Chart.

8-4. CYLINDERS - THEORY OF OPERATION.

- a. Cylinders are of the double acting type. The Lift and Steer systems incorporate double acting cylinders. A double acting cylinder is one that requires oil flow to operate the cylinder rod in both directions. Directing oil (by actuating the corresponding control valve to the piston side of the cylinder) forces the piston to travel toward the rod end of the barrel, extending the cylinder rod (piston attached to rod). When the oil flow is stopped, movement of the rod will stop. By directing oil to the rod side of the cylinder, the piston will be forced in the opposite direction and the cylinder rod will retract.
- b. A holding valve is used in the Lift circuit to prevent retraction of the cylinder rod should a hydraulic line rupture or a leak develop between the cylinder and its related control valve.

8-5. VALVES - THEORY OF OPERATION.

a. Solenoid Control Valves (Bang-Bang).

Control valves used are four-way three-position solenoid valves of the sliding spool design. When a circuit is activated and the control valve solenoid energizes, the spool is shifted and the corresponding work port opens to permit oil flow to the component in the selected circuit, with the opposite work port opening to reservoir. Once the circuit is deactivated (control returned to neutral), the valve spool returns to neutral (center) and oil flow is then directed

Updated 02/93

through the valve body and returns to reservoir. A typical control valve consists of the valve body, sliding spool, and two solenoid assemblies. The spool is machine fitted in the bore of the valve body. Lands on the spool divide the bore into various chambers, which, when the spool is shifted, align with corresponding ports in the valve body open to common flow. At the same time other ports would be blocked to flow. The spool is spring-loaded to center position, therefore when the control is released, the spool automatically returns to neutral, prohibiting any flow through the circuit.

b. Proportional Control Valves.

The proportional control valves provide a power output matching that required by the load. A small line connected to a load sensing port feeds load pressure back to a sequence valve. The sequence valve senses the difference between the load and pump outlet pressure, and varies the pump displacement to keep the difference constant. This differential pressure is applied across the valve's meter-in spool, with the effect that pump flow is determined by the degree of spool opening, independent of load pressure. Return lines are connected together, simplifying routing of return flow and to help reduce cavitation. Load sensing lines connect through shuttle valves to feed the highest load signal back to the sequence valve. Integral actuator port relief valves, anti-cavitation check valves, and load check valves are standard.

c. Relief Valves.

Main relief valves are installed at various points within the hydraulic system to protect associated systems and components against excessive pressure. Excessive pressure can be developed when a cylinder reaches its limit of travel and the flow of pressurized fluid continues from the system control. The relief valve provides an alternate path for the continuing flow from the pump, thus preventing rupture of the cylinder, hydraulic line or fitting. Complete failure of the system pump is also avoided by relieving circuit pressure. The relief valve is installed in the circuit between the pump outlet (pressure line) and the cylinder of the circuit, generally as an integral part of the system valve bank. Relief pressures are set slightly higher than the load requirement, with the valve diverting excess pump delivery back to the reservoir when operating pressure of the component is reached.

d. Crossover Relief Valves.

Crossover relief valves are used in circuits where the actuator requires an operating pressure lower than that supplied to the system. When the circuit is activated and the required pressure at the actuator is developed, the crossover relief diverts excess pump flow to the reservoir. Individual, integral reliefs are provided for each side of the circuit.

8-6. COMPONENT FUNCTIONAL DESCRIPTION.

a. Hydraulic Pump.

The main hydraulic pump is an integral part of the electric motor/pump assembly, located at the rear of the battery and ground control tray on the frame of the machine. The pump is a two-section pump that provides an output of 3.13 gpm (11.8 lpm) from each pump section.

b. Accumulator. (Cushion Cylinder)

The accumulator is located on the rear of the battery and ground control tray on the frame of the machine. The accumulator is a cylinder with an orifice at each end to restrict the flow of hydraulic fluid through the cylinder. The accumulator is mounted inline in the drive circuit and serves to "smooth" acceleration and deceleration of the machine.

c. Lift Cylinder Holding/Manual Descent Valve.

The lift cylinder holding/manual descent valve is located on top of the lift cylinder. The holding valve is a normally closed solenoid valve which holds the platform in place when raised. When activated, the valve opens to permit lift down. A cable is connected to the solenoid valve which, when pulled, manually opens the lift down port of the valve and allows the platform to be lowered in the event hydraulic power is lost.

d. Positive Traction Valve.

The positive traction solenoid valve is located on the main control valve and is activated by a toggle switch on the platform control box. When activated, it equally divides the flow of hydraulic oil in the drive circuit to send an equal amount of oil to each drive motor.

8-7. WEAR PADS.

a. Sliding Pads.

The original thickness of the sliding pads is 3.56 inches (90 mm). Replace sliding pads when worn to 3.25 inches (83 mm).

8-8. CYLINDER CHECKING PROCEDURES.**Note**

Cylinder checks must be performed any time a cylinder component is replaced or when improper system operation is suspected.

- a. Cylinder w/o Counterbalance Valves - Brake Cylinder, Steer Cylinder, Cushion Cylinder (Accumulator).

IMPORTANT**OPERATE FUNCTIONS FROM GROUND CONTROL STATION ONLY.**

- (1). Using all applicable safety precautions, activate motor and fully extend cylinder to be checked. Shut down motor.
- (2). Carefully disconnect hydraulic hose from retract port of cylinder. There will be initial weeping of hydraulic fluid which can be caught in a suitable container. After the initial discharge, there should be no further leakage from the retract port.
- (3). Activate motor and activate cylinder extend function. Check retract port for leakage.
- (4). If cylinder leakage is 6-8 drops per minute or more, piston seals are defective and must be replaced. If cylinder retract port leakage is less than 6-8 drops per minute, carefully reconnect hose to retract port and retract cylinder.
- (5). With cylinder fully retracted, shut down motor and carefully disconnect hydraulic hose from cylinder extend port.
- (6). Activate motor and activate cylinder retract function. Check extend port for leakage.
- (7). If cylinder leakage is 6-8 drops per minute or more, piston seals are defective and must be replaced. If extend port leakage is less than 6-8 drops per minute, carefully reconnect hose to extend port, then activate cylinder through one complete cycle and check for leaks.

- b. Cylinders w/Single Counterbalance Valves - Lift Cylinder.

IMPORTANT**OPERATE ALL FUNCTIONS FROM GROUND CONTROL STATION ONLY.**

- (1). Using all applicable safety precautions, activate hydraulic system.

WARNING

WHEN WORKING ON THE LIFT CYLINDER, RAISE THE PLATFORM COMPLETELY AND SUPPORT THE PLATFORM USING A SUITABLE OVERHEAD LIFTING DEVICE.

DO NOT FULLY EXTEND LIFT CYLINDER TO END OF STROKE. RETRACT CYLINDER SLIGHTLY TO AVOID TRAPPING PRESSURE.

- (2). Raise platform completely, then retract lift cylinder slightly to avoid trapping pressure. Place a suitable overhead lifting device or prop approximately 1 inch (2.5 cm) below the platform.
- (3). Shut down hydraulic system and allow machine to sit for 10-15 minutes. Carefully remove hydraulic hoses from cylinder port block.
- (4). There will be initial weeping of hydraulic fluid, which can be caught in a suitable container. After the initial discharge, there should not be any further leakage from the ports. If leakage continues at a rate of 6-8 drops per minute or more, cylinder repairs must be made. If the retract port is leaking, the piston seals are defective and must be replaced. If the extend port is leaking, the counterbalance valve is defective and must be replaced.
- (5). If no repairs are necessary or when repairs have been made, carefully reconnect hydraulic hoses to the appropriate ports.
- (6). Remove lifting device from platform, activate hydraulic system and run cylinder through one complete cycle to check for leaks.

8-9. CYLINDER REMOVAL AND INSTALLATION.**a. Lift Cylinder Removal.**

- (1). Place the machine on a flat and level surface. Start the motor and raise the platform. Shut down the engine and attach a suitable support device to the platform.
- (2). Remove the two bolts, lockwashers and hex nuts securing the cylinder rod attach pin to the upper inner arm assembly. Using a suitable brass drift, drive out the rod end attach pin from the arm assembly.
- (3). Retract the lift cylinder rod completely.

Updated 02/93

- (4). Tag and disconnect, then cap the lift cylinder hydraulic lines and ports.
- (5). Remove the two bolts securing one of the barrel end attach pin retaining plates to the lower arm assembly. Using a suitable brass drift, drive out the barrel end attach pin from the arm assembly.
- (6). Carefully remove the cylinder from the Sizzor lift and place in a suitable work area.

d. Lift Cylinder Installation.

- (1). Install lift cylinder in place using suitable slings or supports, aligning barrel end attach pin mounting holes on lower arm assembly.
- (2). Using a suitable drift, drive the barrel end attach pin through the mounting holes in the lift cylinder and the lower arm assembly. Secure in place with the pin retaining plate using the two bolts.
- (3). Remove cylinder port plugs and hydraulic line caps and correctly attach lines to cylinder ports.
- (4). Extend the cylinder rod until the attach pin hole aligns with those in the upper arm assembly. Using a suitable drift, drive the cylinder rod attach pin through the aligned holes, taking care to align the pin retaining holes with the stud on the turntable upright. Secure the pin in place with the two bolts, lockwashers and hex nuts.
- (5). Lower platform to stowed position and shut down motor. Check hydraulic fluid level and adjust accordingly.

8-10. CYLINDER REPAIR. (Except Brake Cylinder.)

Note

The following are general procedures that apply to all of the cylinders on this machine, except the brake cylinder. Procedures that apply to a specific cylinder will be so noted.

a. Disassembly.

IMPORTANT

DISASSEMBLY OF THE CYLINDER SHOULD BE PERFORMED ON A CLEAN WORK SURFACE IN A DIRT FREE WORK AREA.

- (1). Connect a suitable auxiliary hydraulic power source to the cylinder port block fitting.

WARNING

DO NOT FULLY EXTEND LIFT CYLINDER TO END OF STROKE. RETRACT CYLINDER SLIGHTLY TO AVOID TRAPPING PRESSURE.

- (2). Operate the hydraulic power source and extend the cylinder. Do not fully extend the cylinder to avoid trapping pressure. Shut down and disconnect the power source. Adequately support the cylinder rod, if applicable.
- (3). If applicable, remove the cartridge-type holding valve and fittings from the cylinder port block. Discard o-rings.
- (4). Place the cylinder barrel into a suitable holding fixture.
- (5). Using a suitable spanner wrench, loosen the cylinder head retainer, if applicable, and/or cylinder head gland, and remove it from the cylinder barrel.
- (6). Attach a suitable pulling device to the cylinder rod port block end or cylinder rod end, as applicable.

IMPORTANT

EXTREME CARE SHOULD BE TAKEN WHEN REMOVING THE CYLINDER ROD, HEAD, AND PISTON. AVOID PULLING THE ROD OFF-CENTER, WHICH COULD CAUSE DAMAGE TO THE PISTON AND CYLINDER BARREL SURFACES.

- (7). With the barrel clamped securely, apply pressure to the rod pulling device and carefully withdraw the complete rod assembly from the cylinder barrel.
- (8). Using suitable protection, clamp the cylinder rod in a vise or similar holding fixture as close to the piston as possible.
- (9). Remove the set screw(s), if applicable, and nut which attach the piston to the rod, and remove the piston. Discard self-locking set screws.
- (10). Remove the piston rings.
- (11). Remove and discard the piston o-rings, seal rings, and backup rings.
- (12). Remove the set screw, if applicable, piston spacer, and wear ring, if applicable, from the rod.
- (13). Remove the rod from the holding fixture. Remove the cylinder head gland and retainer, if applicable. Discard the o-rings, back-up rings, rod seals, and wiper seals.

b. Cleaning and Inspection.

- (1). Clean all parts thoroughly in an approved cleaning solvent.
- (2). Inspect the cylinder rod for scoring, tapering, ovality, or other damage. If necessary, dress rod with Scotch Brite or equivalent. Replace rod if necessary.
- (3). Inspect threaded portion of rod for excessive damage. Dress threads as necessary.
- (4). Inspect inner surface of cylinder barrel tube for scoring or other damage. Check inside diameter for tapering or ovality. Replace if necessary.
- (5). Inspect threaded portion of barrel for damage. Dress threads as necessary.
- (6). Inspect piston surface for damage and scoring and for distortion. Dress piston surface or replace piston as necessary.
- (7). Inspect seal and o-ring grooves in piston for burrs and sharp edges. Dress applicable surfaces as necessary.
- (8). Inspect cylinder head inside diameter for scoring or other damage and for ovality and tapering. Replace as necessary.
- (9). Inspect seal and o-ring grooves in head for burrs and sharp edges. Dress applicable surfaces as necessary.
- (10). If applicable, inspect cylinder head retainer or end cap for surface or thread damage. Repair or replace as necessary.
- (11). Inspect cylinder head outside diameter for scoring or other damage and ovality and tapering. Replace as necessary.
- (12). If applicable, inspect thread ring for scoring or other damage. Dress threads or applicable surfaces as necessary.
- (13). If applicable, inspect rod and barrel bushings for signs of correct lubrication and excessive wear. Replace as necessary.
- (14). Inspect travel limiting collar or spacer for burrs and sharp edges. If necessary, dress inside diameter surface with Scotch Brite or equivalent.
- (15). If applicable, inspect port block fittings and holding valve. Replace as necessary.

- (16). Inspect the oil ports for blockage or the presence of dirt or other foreign material. Repair as necessary.
- (17). If applicable, inspect piston rings for cracks or other damage. Replace as necessary.

c. Assembly.**Notes**

Prior to cylinder assembly, ensure that proper cylinder seal kit is used. Refer to Section 11 of this manual.

Apply a light film of hydraulic oil to all components prior to assembly.

IMPORTANT

WHEN INSTALLING NEW "POLY-PAK" TYPE PISTON SEALS, ENSURE SEALS ARE INSTALLED PROPERLY. REFER TO FIGURE 2-1 FOR CORRECT SEAL ORIENTATION. IMPROPER SEAL INSTALLATION COULD RESULT IN CYLINDER LEAKAGE AND IMPROPER CYLINDER OPERATION.

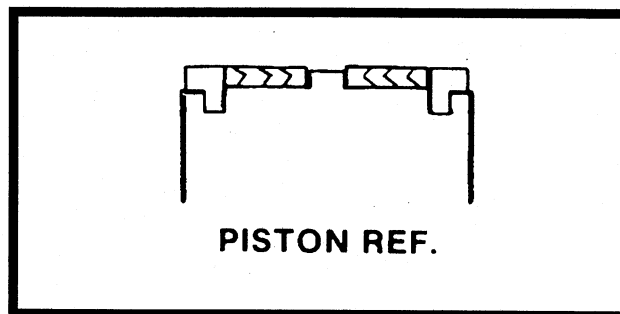

Figure 8-1. Poly-Pak Seal Installation.

- (1). Place a new wiper seal and rod seal into the applicable cylinder head gland grooves.
- (2). Carefully install the head gland on the rod, ensuring that the wiper and rod seals are not damaged or dislodged. Push the head along the rod to the rod end, as applicable.
- (3). Carefully slide the piston spacer on the rod. If applicable, align the oil holes in the rod and the spacer. Secure the spacer, if applicable.
- (4). If applicable, correctly place a new o-ring and back-up rings in the inner piston diameter groove.
- (5). Carefully place the piston on the cylinder rod, ensuring that the o-ring and back-up rings are not damaged or dislodged.

Updated 02/93

- (6). Using suitable protection, clamp the cylinder rod in a vise or similar holding fixture as close to the piston as possible.
- (7). Push the piston onto the rod until it abuts the spacer end and install the attaching nut.

WARNING

IF CYLINDER IS EQUIPPED WITH A PISTON NUT, APPLY "LOCQUIC PRIMER T" AND LOCTITE #242 TO PISTON NUT THREADS, THEN TIGHTEN NUT TO TORQUE SHOWN IN TABLE 8-1.

Note

Self-locking setscrews used on piston nuts should be discarded and replaced whenever they are removed.

Table 8-1. Cylinder Piston Nut Torque Specifications.

Description	Nut Torque Value (w/Loctite)	Setscrew Torque Value (w/o Loctite)
Lift Cylinder	400 ft. lb. (542 Nm)	100 in. lb. (11 Nm)
Traversing Cylinder (If Equipped)	50 ft. lb. (68 Nm)	100 in. lb. (11 Nm)

- (8). If applicable, torque the piston nut to the proper torque as outlined in Table 8-1. Spot drill the cylinder rod at the point where the setscrew is inserted into the piston nut. Install the setscrew(s) which secure the piston attaching nut to the cylinder rod.
- (9). Remove the cylinder rod from the holding fixture.
- (10). Place new o-rings and seals in the applicable outside diameter grooves of both the piston and the cylinder head.
- (11). Position the cylinder barrel in a suitable holding fixture.

IMPORTANT

EXTREME CARE SHOULD BE TAKEN WHEN INSTALLING THE CYLINDER ROD, HEAD, AND PISTON. AVOID PULLING THE ROD OFF-CENTER, WHICH COULD CAUSE DAMAGE TO THE PISTON AND CYLINDER BARREL SURFACES.

- (12). With barrel clamped securely, and while adequately supporting the rod, insert the piston end into the barrel cylinder. Ensure that the piston loading o-ring and seal ring are not damaged or dislodged.

- (13). Continue pushing the rod into the barrel until the cylinder head gland can be inserted into the barrel cylinder.
- (14). If applicable, secure the cylinder head retainer using a suitable spanner type wrench.
- (15). After the cylinder has been reassembled, the rod should be pushed all the way in (fully retracted) prior to the reinstallation of any holding valve or valves.
- (16). If applicable, install the cartridge-type holding valve and fittings in the port block using new o-rings as applicable.

8-11. BRAKE CYLINDER REPAIR. (See Figure 8-2.)

a. Disassembly.

IMPORTANT

DISASSEMBLY OF THE CYLINDER SHOULD BE PERFORMED ON A CLEAN WORK SURFACE IN A DIRT FREE WORK AREA.

- (1). Tag and disconnect the hoses from the cylinder ports.
- (2). Place the cylinder barrel (2) into a suitable holding fixture.

WARNING

THE BRAKE CYLINDER IS EQUIPPED WITH AN INTERNAL COMPRESSION SPRING (1), WHICH HAS A FORCE OF APPROXIMATELY 33 LB. (15 KG) WHEN COMPRESSED. USE EXTREME CAUTION WHEN REMOVING RETAINING RING (14) FROM CYLINDER BARREL.

- (3). Using a suitable pair of snap ring pliers, carefully remove the retaining ring (14) from the cylinder barrel. Use extreme caution when removing the retaining ring, as the internal compression spring (1) is under a tension of approximately 33 lb. (15 kg).
- (4). Attach a suitable pulling device to the cylinder rod end.

IMPORTANT

EXTREME CARE SHOULD BE TAKEN WHEN REMOVING THE CYLINDER ROD, HEAD, AND PISTON. AVOID PULLING THE ROD OFF-CENTER, WHICH COULD CAUSE DAMAGE TO THE PISTON AND CYLINDER BARREL SURFACES.

- (5). With the barrel clamped securely, apply pressure to the rod pulling device and

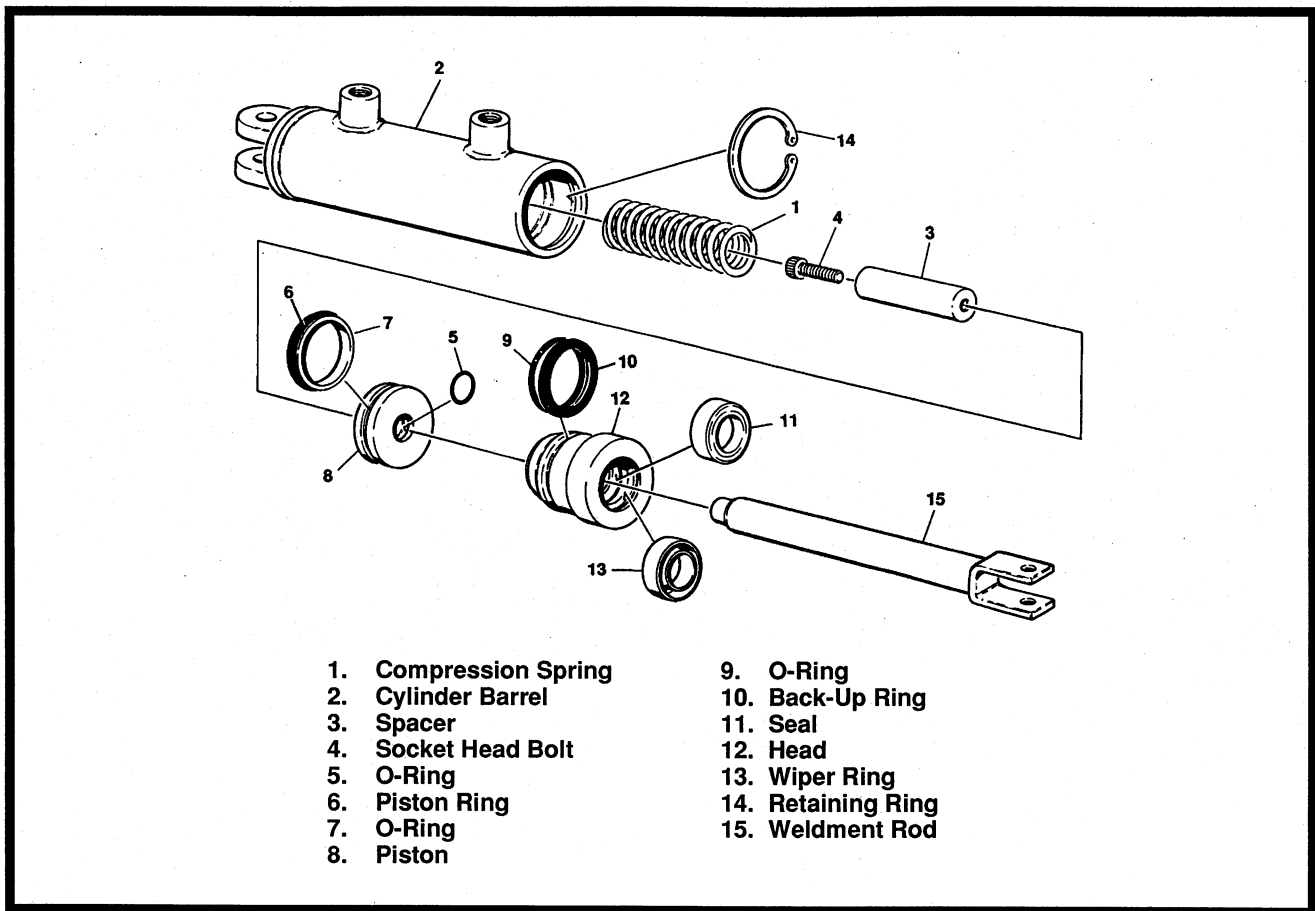

Figure 8-2. Brake Cylinder Assembly.

- carefully withdraw the complete rod assembly from the cylinder barrel.
- (6). Using suitable protection, clamp the cylinder rod (15) in a vise or similar holding fixture.
 - (7). Remove the socket head bolt (4) securing the spacer (3) to the cylinder rod and remove the spacer.
 - (8). Remove the piston (8) from the cylinder rod. Remove and discard the piston ring (6) and o-rings (5 and 7).
 - (9). Carefully remove the head (12) from the cylinder rod. Remove and discard the o-ring (9), backup ring (10), rod seal (11), and wiper seal (13).
 - (10). Remove the cylinder rod from the holding fixture.
- b. Cleaning and Inspection.**
- (1). Clean all parts thoroughly in an approved cleaning solvent.
 - (2). Inspect the cylinder rod for scoring, tapering, ovality, or other damage. If necessary, dress rod with Scotch Brite or equivalent. Replace rod if necessary.
 - (3). Inspect threaded portion of rod for excessive damage. Dress threads as necessary.
 - (4). Inspect inner surface of cylinder barrel tube for scoring or other damage. Check inside diameter for tapering or ovality. Replace if necessary.
 - (5). Inspect piston surface for damage and scoring and for distortion. Dress piston surface or replace piston as necessary.
 - (6). Inspect seal and o-ring grooves in piston for burrs and sharp edges. Dress applicable surfaces as necessary.
 - (7). Inspect cylinder head inside diameter for scoring or other damage and for ovality and tapering. Replace as necessary.

- (8). Inspect seal and o-ring grooves in head for burrs and sharp edges. Dress applicable surfaces as necessary.
- (9). Inspect cylinder head outside diameter for scoring or other damage and ovality and tapering. Replace as necessary.
- (10). Inspect spacer for burrs and sharp edges. If necessary, dress spacer surface with Scotch Brite or equivalent.
- (11). Inspect the oil ports for blockage or the presence of dirt or other foreign material. Repair as necessary.
- (12). Install the compression spring (1) on the piston end of the cylinder rod. With the barrel clamped securely, and while adequately supporting the rod, insert the piston end into the barrel cylinder. Ensure that the piston ring and o-ring are not damaged or dislodged.
- (13). Continue pushing the rod into the barrel until the cylinder head can be inserted into the cylinder barrel.
- (14). Using all applicable safety precautions, secure the cylinder rod assembly with a new retaining ring (14).

c. Assembly.

Notes

Prior to cylinder assembly, ensure that the proper cylinder seal kit is used. Refer to Sections 11 and 13 of this manual.

Apply a light film of hydraulic oil to all components prior to assembly.

- (1). Using suitable protection, clamp the cylinder rod in a vise or similar holding fixture.
- (2). Place a new wiper seal (13), rod seal (11), o-ring (9), and back-up ring (10) into the applicable cylinder head grooves.
- (3). Carefully install the head on the rod, ensuring that the wiper and rod seals are not damaged or dislodged. Push the head onto the rod.
- (4). Place a new piston ring (6) and o-rings (5 and 7) on the piston.
- (4). Carefully place the piston on the cylinder rod, ensuring that the o-ring is not damaged or dislodged. Push the piston onto the rod until it abuts the head.
- (5). Install the spacer (3) on the end of the cylinder rod and secure in place with the socket head bolt (4).
- (6). Remove the cylinder rod from the holding fixture.
- (7). Position the cylinder barrel in a suitable holding fixture.

IMPORTANT

EXTREME CARE SHOULD BE TAKEN WHEN INSTALLING THE CYLINDER ROD, HEAD, AND PISTON. AVOID PULLING THE ROD OFF-CENTER, WHICH COULD CAUSE DAMAGE TO THE PISTON AND CYLINDER BARREL SURFACES.

Updated 02/93

8-12. TILT ALARM SWITCH.

Note

The machine is equipped with a tilt alarm switch (sensor), factory set to activate at 5 degrees and will cut out 2 speed drive. Consult factory for tilt sensor adjustment. The only field adjustment necessary is leveling the switch on the spring loaded studs. There are two methods of adjustment, a manual adjustment and an adjustment using a voltmeter.

CAUTION

PERFORM TILT ALARM SWITCH LEVELING PROCEDURE A MINIMUM OF EVERY SIX MONTHS TO ENSURE PROPER OPERATION AND ADJUSTMENT OF SWITCH.

a. Manual Adjustment.

- (1). Park the machine on a flat, level surface and ensure machine is level.

Note

Ensure switch mounting bracket is level and securely attached.

- (2). Level the base of the indicator by tightening the three flange nuts. Tighten each nut through approximately one half of it's spring's travel. **DO NOT ADJUST THE "X" NUT DURING THE REMAINDER OF THE PROCEDURE.**
- (3). With the electrical connections complete, slowly tighten one of the "Y" nuts until the circuit is closed and the light on the Platform Control Console illuminates.
- (4). Slowly back off the nut, counting the number of turns, until the circuit is again closed and the light again illuminates.

- (5). Divide the number of turns determined in step (4) in half. Tighten the nut this many turns. The line determined by this nut and the "X" nut is now parallel to the ground.
- (6). Repeat steps (3) through (5) for the remaining "Y" nut. The switch is now level.
- (7). Individually push down on one corner at a time; there should be enough travel to cause the switch to trip. If the switch does not trip in all three tests, the flange nuts have been tightened too far. Loosen the "X" nut and repeat steps (3) through (7).

b. Voltmeter Adjustment. (See Figure 8-3.)

- (1). Park machine on a flat, level surface and ensure machine is level.
- (2). If motor is not running, turn ignition switch to ON.
- (3). Connect black lead of voltmeter to ground and red lead to yellow wire protruding from pot on bottom of sensor.
- (4). Adjust leveling nuts to obtain the highest possible voltage reading.
- (5). Check voltage at trip point in all four directions. If voltage reading is not symmetrical, repeat step (4) above.

8-13. LIMIT SWITCH ADJUSTMENT.

a. High Drive Cut-Out Limit Switch.

The high drive cut-out limit switch is located on the left side of the frame of the machine. The switch is activated when the platform is raised above the stowed position. When activated, the switch cuts out the High Drive function.

b. Drive Cut-Out Limit Switch.

The drive cut-out limit switch is located on the right front of the frame of the machine, in front of the sizzor arms. On Models CM2033 and CM2046, the switch is activated when the platform is raised above 17 feet (5.2 meters). On Models CM2546 and CM2558, the switch is activated when the platform is raised above 21 feet (6.4 meters). When activated, the switch cuts out the Drive function.

8-14. PRESSURE SETTING PROCEDURES.

(See Figures 8-4 and 8-5.)

Notes

Make all pressure adjustments with motor operating and hydraulic oil at normal operating temperature.

Drive is governed by P1. Steer and High Drive are governed by P2. On machines built before June 1993, Lift is controlled by P2. On machines built after June 1993, a separate Lift relief valve is provided.

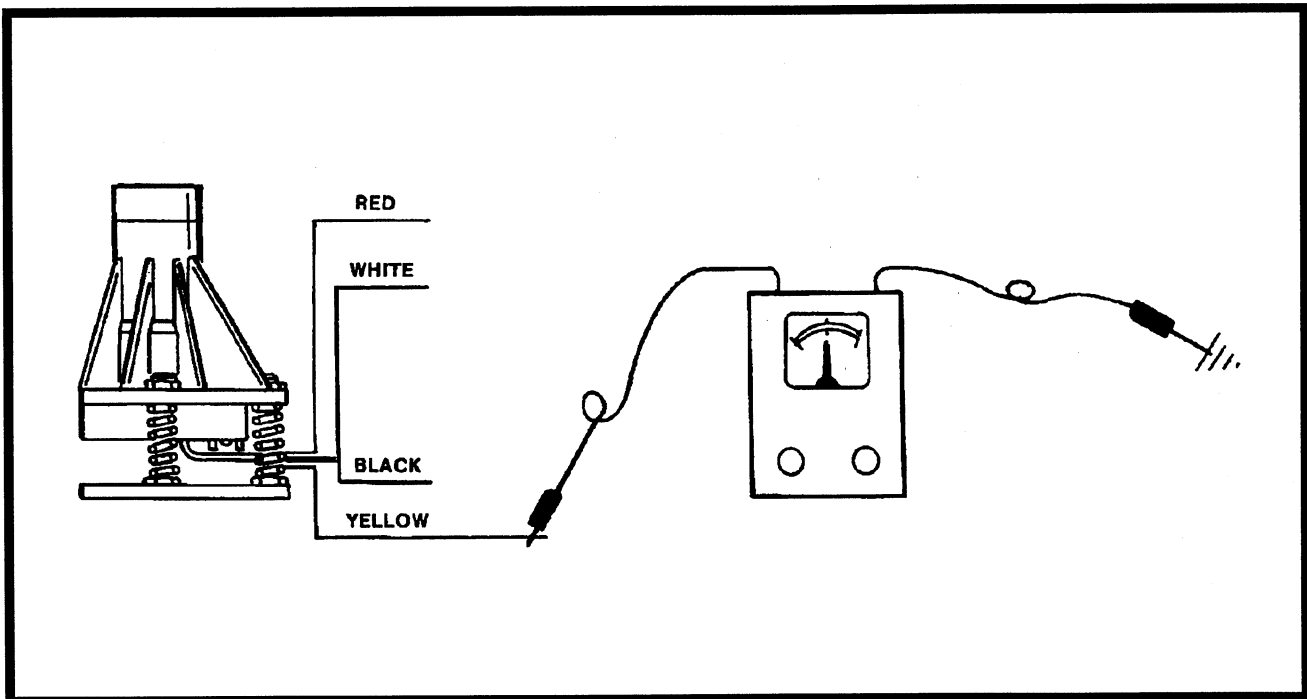

Figure 8-3. Tilt Alarm Switch Leveling - Voltmeter Adjustment.

a. Drive Relief Adjustment.

- (1). Install two pressure gauges, one at gauge port G1 and one at gauge port G2, by installing fittings in valve. G1 and G2 are located adjacent to the steer reliefs, and are identified by stampings on the valve body.
- (2). Disconnect tee fitting from drive tube (M3). Plug and cap tube and tee fitting.
- (3). Energize High Drive, Mid Drive and Drive Forward by positioning High Drive switch to HIGH and activate Drive switch to Drive Forward or by activating Drive controller to Drive Forward.
- (4). On machine with bang-bang drive, adjust P1 to 2700 PSI (186 bar). On machines with proportional drive, adjust P1 to 2700 PSI (186 bar).
- (5). Replace tee fitting to drive tube.

b. Main Relief Adjustment.

Note

Machines built after June 1993 are equipped with a separate Lift relief valve. On these machines, before adjusting main relief, turn the Lift relief valve adjustment all the way in (clockwise).

- (1). Activate Lift Up function and bottom out Lift Up.
- (2). Adjust P2 to 2700 PSI (186 bar).
- (3). Adjust Lift Down Speed Adjustment valve to 25-30 seconds for models CM1432, CM2033, and CM2046, and 30-35 seconds for models CM2546 and CM2558.

c. Lift Relief Adjustment.

(Machines Built After June 1993 Only.)

- (1). Activate Lift Up function and bottom out Lift Up.

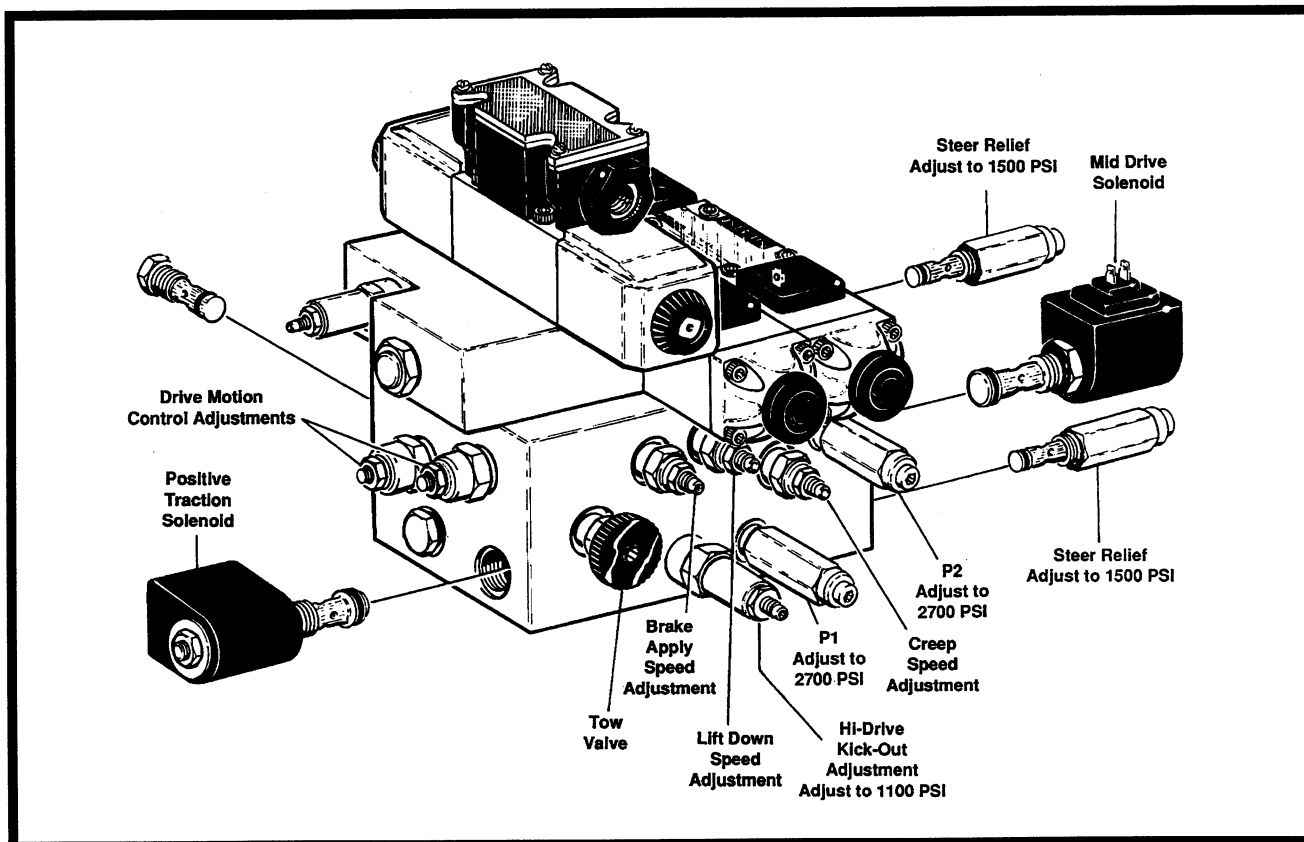

Figure 8-4. Pressure Adjustment Locations - Proportional Valve.

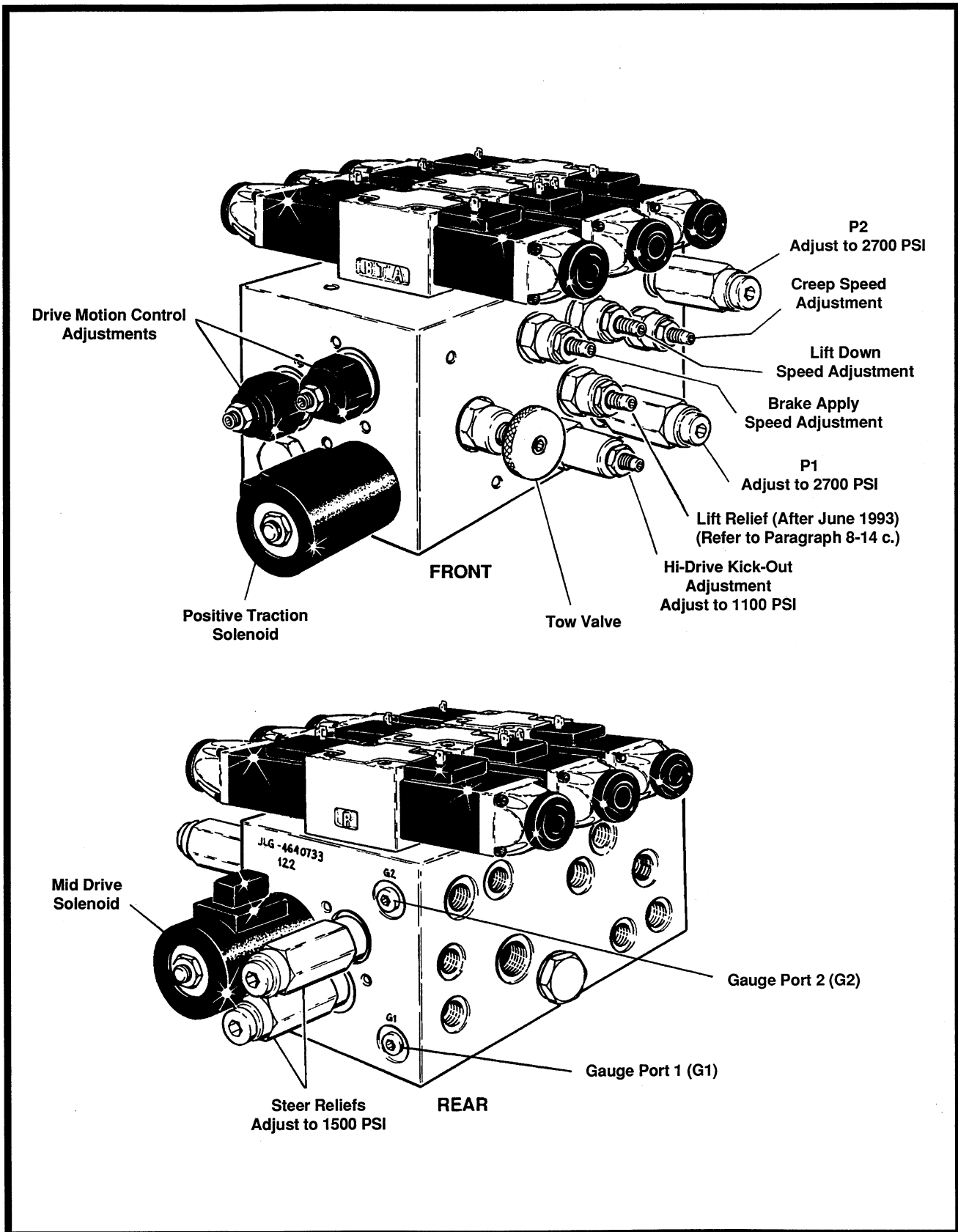

Figure 8-5. Pressure Adjustment Locations - Bang-Bang Valve.

- (2). Adjust Lift relief cartridge as follows:
 CM1432 - 2200 PSI (152 bar).
 CM1432 Plus - Consult Factory.
 CM1732 - 2300 PSI (159 bar).
 CM2033 - 1800 PSI (124 bar).
 CM2046 - 2150 PSI (148 bar).
 CM2546 - 2050 PSI (141 bar).
 CM2558 - 2300 PSI (159 bar).

d. High Drive Adjustment.

- (1). While monitoring pressure gauge at G2, active High Drive and traverse grade until High Drive shifts out. Adjust valve in until gauge at G2 reads 1100 PSI (76 bar) shifting in and out on grade. Stop at this point and lock adjustment screw.

e. Steer Relief Adjustment.

- (1). While monitoring pressure gauge at G2, bottom out Steer Left and adjust S1 to 1500 PSI (103 bar).
 (2). While monitoring pressure gauge at G2, bottom out Steer Right and adjust S2 to 1500 PSI (103 bar).

Note

OC1 and OC2 are set at factory. If not functioning properly, they must be replaced.

8-15. PREVENTIVE MAINTENANCE AND INSPECTION SCHEDULE.

- a.** The preventive maintenance and inspection checks are listed and defined in the following table. This table is divided into two basic parts, the "AREA" to be inspected and the "INTERVAL" at which the inspection is to take place. Under the "AREA" portion of the table, the various systems along with the components that make up that system are listed. The "INTERVAL" portion of the table is divided into five columns representing the various inspection time periods. The numbers listed within the interval column represent the applicable inspection code for which that component is to be checked.
- b.** The checks and services listed in this schedule are not intended to replace any local or regional regulations that may pertain to this type of equipment nor should the lists be considered as all inclusive. Variances in interval times may occur due to climate and/or conditions and depending on the location and use of the machine.

- c.** JLG Industries requires that a complete annual inspection be performed in accordance with the "Annual Machine Inspection Report" form. Forms are supplied with each new machine and are also available from JLG Customer Service. Form must be completed and returned to JLG Industries.

IMPORTANT

JLG INDUSTRIES REQUIRES THAT A COMPLETE ANNUAL INSPECTION BE PERFORMED IN ACCORDANCE WITH THE "ANNUAL MACHINE INSPECTION REPORT" FORM.

Note

This machine requires periodic safety and maintenance inspections be a JLG Dealer. A decal located on the frame affords a place to record (stamp) inspection dates. Notify dealer if inspection is overdue.

d. The inspection and maintenance code numbers are as follows:

1. Check for proper and secure installation.
2. Check for visible damage and legibility.
3. Check for proper fluid level.
4. Check for any structural damage; cracked or broken welds; bent or warped surfaces.
5. Check for leakage.
6. Check for presence of excessive dirt or foreign material.
7. Check for proper operation and freedom of movement.
8. Check for excessive wear or damage.
9. Check for proper tightness and adjustment.
10. Drain, clean and refill.
11. Check for proper operation while pump/motor is running.
12. Check for proper lubrication.
13. Check for evidence of scratches, nicks or rust and for straightness of rod.
14. Check for condition of element; replace as necessary.
15. Check for proper inflation.
16. Check Inspection Decal for current inspection stamp.

Table 8-2. Preventive Maintenance and Inspection Schedule.

PREVENTIVE MAINTENANCE AND INSPECTION SCHEDULE					
AREA	INTERVAL				
	(10 HRS) DAILY	(50 HRS) WEEKLY	(200 HRS) MONTHLY	(500 HRS) 3 MONTH	(1000 HRS) 6 MONTH
PLATFORM					
1. Controller (If Equipped)	1,11				
2. Switches	1,11				
3. Placards and Decals	1,2				
4. Control Tags	1,2				
5. Hose and Cable		4,8			
6. Wear Pads			8		
7. Handrail and Chains	1,4				
CHASSIS					
1. Batteries	3	5			
2. Battery Charger	1				
3. Hydraulic Pump/Motor	1	5			
4. Valves	1	5			
5. Hydraulic Filter (See Lubrication Chart)		5,14	14		
6. Hydraulic Hoses and Tubing	1	5			
7. Hydraulic Oil Tank *	3	5	4		
8. Hydraulic Tank Breather		6,14			
9. Lift Cylinder	1,12	5,6,13	4		
10. Limit Switch	1,7				
11. Placards and Decals	1,2				15
12. Wheel and Tire Assemblies	1	8,9			
13. Drive Motors		1,5,6			
14. Drive Brake		1,6	8		
15. Steer Cylinder	1	5,6,13	4		
16. Steer Components	1	4,6	8		
17. Wheel Bearings			8	12	
18. Sizzor Arms	1,4				
19. Safety Prop	1,4				
20. Wear Pads			8		
21. Pivot Pins/Bolts	1,4		7,8		
22. Switches, Ground Control	1,11				
23. Control Tags	1,2				
24. Placards and Decals	1,2				
25. Hose and Cable	1	4,8			

* Inspection and Maintenance Code 10 to be performed annually.

9-1. GENERAL.

This section contains troubleshooting information to be used for locating and correcting most of the operating problems which may develop in the aerial platform. If a problem should develop which is not presented in this section or which is not corrected by listed corrective actions, technically qualified guidance should be obtained before proceeding with any maintenance.

9-2. TROUBLESHOOTING INFORMATION.

- a. The troubleshooting procedures applicable to the aerial platform are listed and defined in Tables 9-1 through 9-6. As an aid to table use, the aerial platform is divided into six major groups, each covered separately within this section. These groups are as follows: platform assembly, boom assembly, turntable assembly, chassis assembly, hydraulic system and electrical system.
- b. Each malfunction within an individual group or system is followed by a listing of probable causes which will enable determination of the applicable remedial action. The probable causes and the remedial action should, where possible, be checked in the order listed in the tables.
- c. It should be noted that there is no substitute for a thorough knowledge of the equipment and related systems.
- d. It should be recognized that the majority of the problems arising in the machine will be centered in the hydraulic and electrical systems. For this reason, every effort has been made to ensure that all likely problems in these areas are given the fullest possible treatment. In the remaining machine groups, only those problems which are symptomatic of greater problems which have more than one probable cause and remedy are included. This means that problems for which the probable cause and remedy may be immediately obvious are not listed in this section.
- e. The first rule for troubleshooting any circuit that is hydraulically operated and electrically controlled is to determine if the circuit is lacking hydraulic oil and electrical control power. This can be ascertained by overriding the bypass valve (mechanically or electrically) so that oil is available to the function valve, then overriding the function valve mechanically. If the function performs satisfactorily, the problem exists with the control circuit.

9-3. HYDRAULIC CIRCUIT CHECKS.

The first reference for improper function of a hydraulic system, where the cause is not immediately apparent, should be the Troubleshooting Chart. The best place to begin the problem analysis is at the power source (pump). Once it is determined that the pump is serviceable, then a systematic check of the circuit components, beginning with the control, would follow. For aid in troubleshooting, refer to the Illustrated Parts Manual for hydraulic diagrams of the various circuits.

Table 9-1. Elevation System Troubleshooting.

TROUBLE	PROBABLE CAUSE	REMEDY
Platform Elevation System.		
No response to control switch.	Lift control switch inoperative.	Repair or replace control switch.
	Hydraulic system oil low.	Replenish oil as necessary.
	Restricted or broken supply line on valve bank or hydraulic pump.	Clean, repair or replace line.
	Control valve not functioning properly.	Repair or replace valve.
	Lift cylinder not functioning properly.	Repair or replace cylinder.
	Hydraulic pump not functioning properly.	Repair or replace pump.
	Platform overloaded.	Correct overload condition.
Platform will not raise.	Load capacity exceeded. (Personnel and/or equipment on platform.)	Reduce load. (Refer to capacity placard.)
	Hydraulic system oil low.	Replenish oil as necessary.
	Restricted or broken hydraulic line or fitting.	Clean, repair, or replace line or fitting.
	Control valve not functioning properly.	Repair or replace valve.
	Lift cylinder not functioning properly.	Repair or replace cylinder.
	Motor/Pump does not respond when LIFT control switch is moved to UP position.	Refer to Electrical System Troubleshooting Chart. No response to control switch.
	No electrical signal being sent to LIFT UP control valve cartridge.	Refer to Electrical System Troubleshooting Chart. No response to control switch.
Platform will not lower.	No electrical signal sent to LIFT DOWN control valve cartridge.	Refer to Electrical System Troubleshooting Chart. No response to control switch.
	LIFT DOWN control valve cartridge not functioning properly.	Repair or replace LIFT DOWN control valve cartridge.
	Lift cylinder not functioning properly.	Repair or replace cylinder.
	Motor/Pump does not respond when LIFT control switch is moved to DOWN position.	Refer to Electrical System Troubleshooting chart. No response to control switch.
	No electrical signal being sent to LIFT DOWN control valve	Refer to Electrical System Troubleshooting chart. No response to control switch.

Table 9-1. Elevation System Troubleshooting.

TROUBLE Platform Elevation System. (cont.)	PROBABLE CAUSE	REMEDY
Platform raises and lowers erratically.	Hydraulic system oil low.	Replenish oil as required.
	Restricted or broken hydraulic line or fitting.	Clean or replace line.
	Lack of lubricant on lift cylinder attach pins.	Lubricate as required. (Refer to Lubrication Chart)
	Counterbalance valve on lift cylinder improperly adjusted or not functioning properly.	Replace valve.
	Control valve not functioning properly.	Repair or replace valve.
	Worn seals in lift cylinder.	Replace seals.
	Cylinder not functioning properly.	Repair or replace cylinder.
Platform drifts down.	Manual lowering valve not functioning properly.	Repair or replace valve.
	Worn seals in lift cylinder.	Replace seals.
	Holding valve on lift cylinder not functioning properly.	Repair or replace valve.
Drive does not operate below 17 feet (5.2 meters) on Models CM2033 and CM2046.	Damaged wire on limit switch.	Repair or replace wiring.
	Damaged limit switch.	Replace limit switch.
Drive does not operate below 21 feet (6.4 meters) on Models CM2546 and CM2558.	Damaged wire on limit switch.	Repair or replace wiring.
	Damaged limit switch.	Replace limit switch.
High Drive does not operate below horizontal.	Damaged wiring on limit switch.	Repair or replace wiring.
	Damaged limit switch.	Replace limit switch.

Table 9-2. Chassis Troubleshooting.

TROUBLE	PROBABLE CAUSE	REMEDY
Drive System.		
No response to control.	Hydraulic system oil low.	Replenish oil as necessary.
	Hydraulic pump not functioning properly.	Repair or replace pump.
	Restricted or broken pump supply line.	Clean, repair or replace line.
	Drive motor(s) not functioning properly.	Repair or replace motor(s).
	Damaged wiring on control switch.	Repair or replace wiring.
	Control switch not functioning properly.	Replace switch.
	Drive brake not releasing.	Determine cause and repair or replace brake.
Machine drives erratically. (PQ Controller Drive.)	Microswitch on controller improperly adjusted.	Adjust microswitch on controller for proper operation.
Machine will not travel forward.	Hydraulic system oil low.	Replenish oil as necessary.
	Restricted or broken hydraulic line or fitting.	Clean, repair or replace line or fitting.
	Control valve not functioning properly.	Repair or replace valve.
	Drive motor(s) not functioning properly.	Repair or replace motor(s).
	Brake cylinder not functioning properly.	Repair or replace brake cylinder.
	Motor/Pump will not respond when DRIVE control is moved to FORWARD position.	Refer to Electrical System Troubleshooting Chart. No response to control switch.
	No electrical signal being sent to the Drive valve cartridge.	Refer to Electrical System Troubleshooting Chart. No response to control switch.
Machine will not travel in reverse.	See: Machine will not travel forward.	

Table 9-2. Chassis Troubleshooting.

TROUBLE	PROBABLE CAUSE	REMEDY
Drive System. (continued)		
Machine overspeeds when descending a grade.	Overcenter cartridge not functioning properly.	Replace overcenter cartridge.
High-Speed Drive function does not operate. (Toggle Switch Drive)	Loose or damaged wiring between DRIVE control and High Speed switch.	Ensure proper connection of wires. Using suitable test meter, perform continuity test on wiring between switches. Repair or replace wires as necessary.
	Defective high speed control switch.	Replace switch.
	Loose or damaged wire in control box wire harness.	Ensure proper connection of wire at the control switch. Using suitable test meter, perform continuity test on wire. Repair or replace harness as necessary.
	Loose or damaged wire between platform and high speed solenoid.	Ensure proper connection of wire at the platform and at the high speed solenoid. Using suitable test meter, perform continuity test on wire. Repair or replace harness as necessary.
	High speed solenoid not functioning properly.	Replace solenoid.
	Loose or damaged wires between high speed relay and high speed limit switch.	Ensure proper connection of wires between high speed relay and high speed limit switch. Using suitable test meter, perform continuity test on wires. Repair or replace wires as necessary.
	High speed limit switch not functioning properly.	Repair or replace limit switch.
	Loose or damaged wire in valve wiring harness.	Ensure proper connection of wires at terminal strip. Using suitable test meter, perform continuity test on wires. Repair or replace harness as necessary.
	Motor/pump assembly defective.	Replace motor/pump assembly.

Table 9-2. Chassis Troubleshooting.

TROUBLE	PROBABLE CAUSE	REMEDY
Steering System. No response to control.	Hydraulic system oil low.	Replenish oil as necessary.
	Hydraulic system pressure too low.	Adjust pressure.
	Damaged wiring on control switch or solenoid valve.	See proper wiring diagram.
	Control switch not functioning properly.	Replace switch.
	Restricted or broken hydraulic line on valve bank or hydraulic pump.	Clean, repair or replace line.
	Control valve not functioning properly.	Repair or replace valve.
	Steer cylinder not functioning properly.	Repair or replace cylinder.
Machine hard to steer or steering is erratic.	Hydraulic system oil low.	Replenish oil as necessary.
	Restricted hydraulic line or fitting.	Clean, repair or replace line or fitting.
	Lack of lubrication.	Lubricate as required. (Refer to Lubrication Chart.)
	Restricted crossover relief valve.	Clean or replace valve.
	Steer system pressure low.	Adjust pressure.
	Bent steering linkage.	Repair or replace linkage as required.
	Hydraulic pump not functioning properly.	Repair or replace pump.
Steering inoperative.	Steer cylinder not functioning properly.	Repair or replace cylinder.
	Damaged wiring on control switch or solenoid valve.	See proper wiring diagram.
	Solenoid valve not functioning properly.	Repair or replace valve.
	Control switch not functioning properly.	Replace switch.
	Relief valve improperly set or not functioning properly.	Reset, repair or replace valves as required.
	Steer cylinder not functioning properly.	Repair or replace cylinder.
	Machine will not steer left or right.	Wiring on control switch is damaged.
Wiring on solenoid valve damaged.		Repair or replace wiring.
Coil in solenoid damaged.		Replace coil.
Bent cylinder rod.		Repair or replace cylinder.
Damaged steer linkage.		Repair or replace steer linkage.
Machine wanders; steering not firm.	Crossover relief valve set too low or not functioning properly.	Reset, repair or replace valve as required.
	Steer linkages loose.	Tighten linkage.
	Steer wheel toe-in not set properly.	Adjust toe-in for 1/4 inch overall.
	Spindle bushings badly worn.	Replace bushings.

Table 9-3. Hydraulic System Troubleshooting.

TROUBLE	PROBABLE CAUSE	REMEDY
Hydraulic System - General.		
Hydraulic pump noisy.	Air entering system through broken line or fitting. (Suction Side.)	Repair or replace line or fitting.
	Air bubbles in oil. (Reservoir oil too low.)	Replenish oil as required.
	Oil filter dirty.	Clean and/or replace filter as necessary.
	Restricted suction line.	Clean, repair, or replace line.
	Restricted reservoir air vent.	Clean vent.
Pump cavitating. (Vacuum in pump due to oil starvation.)	Oil viscosity too high.	Drain system and replace with recommended oil. (Refer to Hydraulic Oils.)
	Leak in suction line or manifold.	Repair or replace line or manifold as necessary.
	Oil viscosity too high.	Drain system and replace with recommended hydraulic oil.
	Main relief valve set too high.	Reset valve as required.
System overheating.	Hydraulic system oil low.	Replenish oil as necessary.
	Extended driving periods.	Do not drive machine for extended periods.
	Defective pump on motor.	Repair or replace motor.
Pump not delivering oil.	Restricted suction line.	Clean, repair, or replace line.
	Air entering system through broken line or fitting. (Suction side.)	Repair or replace line or fitting.
System pressure too low.	Main relief valve set too low.	Reset valve as required.
	Hydraulic pump not functioning properly.	Repair or replace pump.
	Leak in component, line or fitting.	Repair or replace component, line or fitting.
	Scored valve spool; scored cylinder.	Replace valve; replace cylinder.
System(s) operate erratically.	Sticking or binding valve cartridge, piston rod, etc.	Clean, repair or replace components as required.
	Hydraulic oil not at operating temperature.	Allow oil sufficient time to warm up.

Table 9-4. Electrical System Troubleshooting.

TROUBLE	PROBABLE CAUSE	REMEDY
Hand Controller.		
Valve will not function when handle is moved in either direction.	No electrical power to handle.	Check electrical input to hand controller (12V).
	No electrical power to valve.	Check electrical output of printed circuit board and electrical signal at the valve.
	Improper ground.	Check for proper grounding of handle.
Control Switches.		
No response to a function control switch.	Master EMERGENCY STOP switch not positioned properly.	Place EMERGENCY STOP switch to "ON".
	POWER SELECTOR switch on ground control box not positioned properly.	Place POWER SELECTOR switch to PLATFORM or GROUND, as required.
	Battery charger connected and in service.	Disconnect battery charger.
	Circuit breaker open.	Determine and correct cause. Reset circuit breaker.
	Batteries defective or require charging.	Test batteries for serviceability. Replace or charge batteries as necessary.
	No voltage present at EMERGENCY STOP switch.	Check battery cable from battery bank to EMERGENCY STOP switch for proper connection or damage. Repair or replace cable as necessary.
	EMERGENCY STOP switch not functioning properly.	Replace switch.
	No voltage supplied to electric motor start relay from EMERGENCY STOP switch.	Check battery cable from switch to relay for proper connection or damage. Repair or replace cable as necessary.
	No voltage input at terminal strip.	Check wire from battery bank to terminal strip for proper connection or damage. Repair or replace wire as necessary.
	No voltage present at circuit breaker.	Check wire from terminal strip to circuit breaker for proper connection or damage. Repair or replace wire as necessary.
Defective circuit breaker.	Replace circuit breaker.	

Table 9-4. Electrical System Troubleshooting.

TROUBLE	PROBABLE CAUSE	REMEDY
Control Switches. (cont.)		
No response to a function control switch. (cont.)	No voltage present at charge relay.	Check wire from charge relay to terminal strip for proper connection or damage. Repair or replace wire as necessary.
	Defective charge relay.	Replace charge relay.
	No voltage supplied to terminal strip from charge relay.	Check wire from charge relay to terminal strip for proper connection or damage. Repair or replace wire as necessary.
	No voltage present at control box EMERGENCY STOP switch.	Unplug control box harness from platform receptacle. Check wire from applicable pin in plug to control box EMERGENCY STOP switch for proper connection. Using suitable test meter, perform continuity test on wire. Repair or replace harness as necessary.
	Defective EMERGENCY STOP switch in control box.	Replace EMERGENCY STOP switch.
	No voltage present at function control switch.	Check wiring from EMERGENCY STOP switch to function control switch for proper connection or damage. Repair or replace wiring as necessary.
	Defective function control switch.	Replace function control switch.
	No voltage present at applicable points of the terminal strip. (Note: Actuation of a function control switch should simultaneously send an electrical signal to two separate points on the terminal strip. One signal for activation of the control valve coil and another signal for the activation of the electric motor start relay.)	Unplug control box harness from platform receptacle. Check applicable wires for proper connection in control box, at control box plug, at platform receptacle and at terminal strip. Using suitable test meter, perform continuity check on wires. Repair or replace harness as necessary.
	No voltage present at applicable control valve coil.	Check applicable wire for proper connection at terminal strip, valve harness plug pin, valve harness receptacle pin and valve coil. Using suitable test meter, perform continuity test on wire. Repair or replace wire or harness as necessary.
	No voltage supplied from terminal strip to electric motor start relay.	Check applicable wire for proper connection at terminal strip, valve harness plug pin, valve harness receptacle pin and electric motor start relay. Using suitable test meter, perform continuity test on wire. Repair or replace wire or harness as necessary.

Table 9-4. Electrical System Troubleshooting.

TROUBLE	PROBABLE CAUSE	REMEDY
Control Switches. (cont.)		
No response to a function control switch. (cont.)	Defective electric motor start relay.	Replace electric motor start relay.
	No voltage supplied to motor from start relay.	Check battery cable from relay to motor for proper connection or damage. Repair or replace cable as necessary.
	Defective motor/pump assembly.	Replace motor/pump assembly.
Motor/Pump.		
Hydraulic pump/electric motor inoperative.	Batteries require charging or will not hold a charge.	Charge or replace batteries as required.
	Damaged wiring on control switch.	Repair or replace wiring.
	Control switch not functioning properly.	Replace switch.
	Pump motor relay not functioning properly.	Repair or replace relay.
	Pump motor not functioning properly.	Repair or replace motor.



TRANSFER OF OWNERSHIP

To: JLG, Gradall, Lull and Sky Trak product owner:

If you now own, but ARE NOT the original purchaser of the product covered by this manual, we would like to know who you are. For the purpose of receiving safety-related bulletins, it is very important to keep JLG Industries, Inc. updated with the current ownership of all JLG products. JLG maintains owner information for each JLG product and uses this information in cases where owner notification is necessary.

Please use this form to provide JLG with updated information with regard to the current ownership of JLG Products. Please return completed form to the JLG Product Safety & Reliability Department via facsimile (717) 485-6573 or mail to address as specified on the back of this form.

Thank you,
Product Safety & Reliability Department
JLG Industries, Inc.
1 JLG Drive
McConnellsburg, PA 17233-9533
Telephone: (717) 485-5161
Fax: (717) 485-6573

NOTE: Leased or rented units should not be included on this form.

Mfg. Model: _____

Serial Number: _____

Previous Owner: _____

Address: _____

City: _____ State: _____

Zip: _____ Telephone: (_____) _____

Date Of Transfer: _____

Current Owner: _____

Address: _____

City: _____ State: _____

Zip: _____ Telephone: (_____) _____

Who in your organization should we notify?

Name: _____

Title: _____

Please cut on the dotted line and fax to 717-485-6573





Corporate Office
JLG Industries, Inc.
1 JLG Drive
McConnellsburg PA. 17233-9533
USA
Phone: (717) 485-5161
Customer Support Toll Free: (877) 554-5438
Fax: (717) 485-6417

JLG Worldwide Locations

JLG Industries (Australia)
P.O. Box 5119
11 Bolwarra Road
Port Macquarie
N.S.W. 2444
Australia
Phone: (61) 2 65 811111
Fax: (61) 2 65 810122

JLG Industries (UK)
Unit 12, Southside
Bredbury Park Industrial Estate
Bredbury
Stockport
SK6 2sP
England
Phone: (44) 870 200 7700
Fax: (44) 870 200 7711

JLG Deutschland GmbH
Max Planck Strasse 21
D-27721 Ritterhude/Idpohl
Bei Bremen
Germany
Phone: (49) 421 693 500
Fax: (49) 421 693 5035

JLG Industries (Italia)
Via Po. 22
20010 Pregnana Milanese - MI
Italy
Phone: (39) 02 9359 5210
Fax: (39) 02 9359 5845

JLG Latino Americana Ltda.
Rua Eng. Carlos Stevenson,
80-Suite 71
13092-310 Campinas-SP
Brazil
Phone: (55) 19 3295 0407
Fax: (55) 19 3295 1025

JLG Europe B.V.
Jupiterstraat 234
2132 HJ Foofddorp
The Netherlands
Phone: (31) 23 565 5665
Fax: (31) 23 557 2493

JLG Industries (Norge AS)
Sofeimyrveien 12
N-1412 Sofienyr
Norway
Phone: (47) 6682 2000
Fax: (47) 6682 2001

JLG Polska
Ul. Krolewska
00-060 Warszawa
Poland
Phone: (48) 91 4320 245
Fax: (48) 91 4358 200

JLG Industries (Europe)
Kilmartin Place,
Tannochside Park
Uddingston G71 5PH
Scotland
Phone: (44) 1 698 811005
Fax: (44) 1 698 811055

JLG Industries (Pty) Ltd.
Unit 1, 24 Industrial Complex
Herman Street
Meadowdale
Germiston
South Africa
Phone: (27) 11 453 1334
Fax: (27) 11 453 1342

Plataformas Elevadoras
JLG Iberica, S.L.
Trapadella, 2
P.I. Castellbisbal Sur
08755Castellbisbal
Spain
Phone: (34) 93 77 24700
Fax: (34) 93 77 11762

JLG Industries (Sweden)
Enkopingsvagen 150
Box 704
SE - 175 27 Jarfalla
Sweden
Phone: (46) 8 506 59500
Fax: (46) 8 506 59534
